



Operation Manual

Air-cooled Thermo-con

Model No.

HEC002-A5*

HEC006-A5*



Keep this manual available at all times.

History

Version	Preface	Contents	Chap.1	Chap.2	Chap.3	Chap.4	Chap.5
1.0							
1.1			1.1			1.1	
1.2	1.2	1.2		1.2	1.2	1.2	1.2
1.3		1.3			1.3		
1.4		1.4		1.4			1.4
1.5		1.5		1.5		1.5	1.5
1.6				1.6			

Version	Chap.6	Chap.7	Chap.8	Chap.9	Chap.10
1.0					
1.1	1.1				
1.2	1.2	1.2			1.2
1.3		1.3			
1.4					
1.5		1.5			
1.6					

Record of Changes

Version	Contents	Date
1.0	First edition	Sep.2005
1.1	1.2: Change the address of R&D Center. 4.1: Add model option. 6.1: Change Accuracy related to temp(stability)	Jul.26.2006
1.2	Add HEC006-A	May.20.2008
1.3	Add caution of the heavy object. Modify supply circulating fluid and drain	Jun.30.2008
1.4	2.4: Add Disposing of product 5.2.3: Modify opening and closing of reservoir cap.	Nov.5.2014
1.5	Model No. label changed	Jan.29.2016
1.6	Add Warning and Caution label	Apr.20.2018

Preface

Thank you very much for purchasing SMC Thermo-con. (herein referred to as the “product”).

This manual describes the operation of the product. Please use this manual for efficient and long use of this unit. Be sure to read this manual efficiently for your deep understanding of overview and safety of this unit before installation or carrying out the relevant operations of this unit. Especially, you need to follow the instructions about “Danger”, “Warning” and “Caution”.

Packaged items

No.	Item	Qty.
1	Product	1
2	Power supply cable	1
3	Foot (mounting bracket)	2
4	Operation Manual	1

Contents

	Page No.
1 Introduction-----	1-1
1.1 Scope and general description of use -----	1-1
1.2 Operation by external communication -----	1-1
1.3 Contents of operation manual -----	1-2
2 Safety Instructions -----	2-1
2.1 Before using the Thermo-con -----	2-1
2.1.1 Safety training -----	2-1
2.1.2 Identification of “Danger”, “Warning”, “Caution” and “Note” -----	2-1
2.2 “Warning” label and “Caution” label -----	2-3
2.2.1 The position of attached “Warning” label and “Caution” label -----	2-3
2.3 Precautions for running(safety interlock)-----	2-4
2.3.1 Interlock list -----	2-5
2.4 Disposing of product -----	2-6
3 Caution on Installation -----	3-1
3.1 Environment -----	3-1
3.2 Installation -----	3-2
3.3 Mounting -----	3-2
3.4 Piping -----	3-3
3.5 Handling -----	3-3
4 Unit overview-----	4-1
4.1 Method of identifying model -----	4-1
4.2 Manufacturing years method of display -----	4-1
4.3 Model No. label -----	4-1
4.4 Appearance -----	4-2
4.5 Outline of operation -----	4-3
4.5.1 Electrical diagram -----	4-3
4.5.2 Mechanical system -----	4-3
4.6 Functions -----	4-4
4.6.1 Auto tuning -----	4-4
4.6.2 Offset function -----	4-4
4.6.3 Learning control function -----	4-4
4.6.4 External tune control function -----	4-4
4.6.5 Temperature sensor fine control function -----	4-4
4.6.6 Setting value memory function -----	4-4

4.6.7	Upper/Lower temperature limit alarm function -----	4-7
5	Names and Functions of Components -----	5-1
5.1	Side view -----	5-1
5.1.1	HEC002 -----	5-1
5.1.2	HEC006 -----	5-1
5.1.3	Air Filter -----	5-2
5.2	Top view -----	5-2
5.2.1	Operation panel -----	5-3
5.2.2	Display -----	5-3
5.2.3	Reservoir Cap -----	5-4
5.3	Auto tuning function -----	5-4
6	Specifications -----	6-1
6.1	Specification table -----	6-1
6.2	Performance chart -----	6-2
	1) Cooling capacity -----	6-2
	2) Heating capacity -----	6-2
	3) Pump capacity -----	6-3
7	Preparation for Operation -----	7-1
7.1	Preparation for circulating fluid -----	7-1
7.2	Power supply -----	7-2
7.3	Grounding -----	7-2
7.4	Supply circulating fluid and drain -----	7-2
7.5	Check - repair -----	7-3
7.5.1	Daily check -----	7-3
7.5.2	Check after seismic vibration and impact -----	7-4
7.5.3	Repair and maintenance -----	7-4
8	Operation -----	8-1
8.1	Condition after power up -----	8-1
8.2	How to operate -----	8-1
8.3	Setting mode, Level 1 -----	8-2
8.3.1	How to enter and return -----	8-2
8.3.2	Available mode in Level 1 -----	8-2
8.4	Setting mode, Level 2 -----	8-3
8.4.1	How to enter and return -----	8-3
8.4.2	Available mode in Level 2 -----	8-3

8.5	Setting mode, Level 3 -----	8-5
	8.5.1 How to enter and return-----	8-5
	8.5.2 Available mode in Level 3 -----	8-5
8.6	Detail of setting mode level-----	8-6
	8.6.1 Setting mode, Level 1 -----	8-6
	8.6.2 Setting mode, Level 2 -----	8-8
	8.6.3 Setting mode, Level 3 -----	8-10
9	Alarm-----	9-1
9.1	How to Identify Alarm -----	9-1
9.2	Alarm indication-----	9-1
9.3	How to reset alarm-----	9-2
9.4	Alarm code list -----	9-2
9.5	Troubleshooting-----	9-4
10	Appendix-----	10-1
10.1	Signal and style of connectors -----	10-1
10.2	Calculation of dew point (from psychometric chart) -----	10-2
10.3	Power supply cable -----	10-2

Figure List

	Page No.
Fig. 2-1 The position of attaching “Warning” label and “Caution” label -----	2-3
Fig. 2-2 Detail of “Warning” label and “Caution” label-----	2-3
Fig. 3-1 Installation environment -----	3-2
Fig. 3-2 Installation environment (when the back side has been blocked) -----	3-2
Fig. 3-3 Mounting -----	3-3
Fig. 4-1 Position of Model No. label -----	4-1
Fig. 4-2 Legend of Model No. label -----	4-1
Fig. 4-3 Outside drawings of Thermo-con -----	4-2
Fig. 4-4 Electrical diagram -----	4-3
Fig. 4-5 Circulating fluid circuit-----	4-3
Fig. 5-1 HEC002-A -----	5-1
Fig. 5-2 HEC006-A -----	5-1
Fig. 5-3 Air Filter-----	5-2
Fig. 5-4 Top view-----	5-2
Fig. 5-5 Operation panel-----	5-3
Fig. 5-6 Display-----	5-3
Fig. 5-7 Reservoir Cap-----	5-4
Fig. 6-1 Cooling capacity -----	6-2
Fig. 6-2 Heating capacity-----	6-2
Fig. 6-3 Pump capacity -----	6-3
Fig. 9-1 Alarm indication in the event ERR14 arises -----	9-1
Fig. 9-2 Alarm indication in the event ERR14 arises during PB width setting input -----	9-1
Fig. 9-3 Alarm indication in the event temp. upper and lower limit arises -----	9-1
Fig. 10-1 Moisture air diagram -----	10-2

Table List

	Page No.
Table 2-1 Division of DANGER, WARNING, CAUTION, and NOTE-----	2-2
Table 2-2 Meaning of a symbol -----	2-2
Table 2-3 Safety interlock list(Part 1) -----	2-5
Table 2-4 Safety interlock list(Part 2) -----	2-5
Table 6-1 Specifications -----	6-1
Table 8-1 Available mode in Level 1 -----	8-2
Table 8-2 Available mode in Level 2 -----	8-4
Table 8-3 Available mode in Level 3 -----	8-5
Table 9-1 Alarm information -----	9-1
Table 9-2 Reset of alarm -----	9-2
Table 9-3 Alarm code list -----	9-2
Table 9-4 Troubleshooting -----	9-4
Table 10-1 Signal and style of connectors-----	10-1
Table 10-2 Power Supply Cable -----	10-2

Abbreviations

Abbreviation (The order of ABC)	Meaning
AC	Alternating Current
AT	Auto Tuning
Chap.	Chapter
DC	Direct Current
EMI	Electro Magnetic Interference
EPDM	Ethylene Propylene Diene Monomer
ERR	Error
IEC	International Electrotechnical Commission
LCD	Liquid Crystal Display
PE (Electricity)	Protective Earth
PE (Material)	Polyethylene
PID	Proportional, Integral, Differentiate
PPS	Polyphenylene Sulfide
PV	Process Value
RET	Return
RXD	Received Data
SEL	Select
SER (No.)	Serial (No.)
SG	Signal Ground
SUS	Special Use Stainless steel
SV	Setting Value
Temp.	Temperature
TXD	Transmitted Data
WRN	Warning

1 Introduction

The definition and construction of operation manual are described below.

1.1 Scope and general description of use

The operation manual applies to operation method of SMC-brand Thermo-con HEC002-A and HEC006-A. Thermo-con is air-to-liquid heat exchanger to be used to control the temperature (e.g. detectors in an X-Ray system). It aims easier understanding of operational and Installation information of the Thermo-con. Before any operation and Installation of this unit, be sure to read this operation manual carefully and understand the contents well.

This unit is Class 1 equipment with regard to the type of protection for electric shock.

1.2 Operation by external communication

It complies with communication standard RS-232C and RS-485. RS-232C can have a cable with length up to 15m. RS-485 can have a cable with length up to 500m.

The content which can be communicated is as follows.

- 1) Setting and reading of target temperature
- 2) Reading of the value detected by temperature sensor
- 3) Reading of warning status
- 4) Setting and reading of off-set value

For operation by communication, it is necessary to order "Communication Specifications".

<Contact>

If you have any questions or are unclear about any of the content of this manual, please contact the following department.

SMC Corporation R&D Center
Product Development Division-6
Address: 4-2-2, KINUNODAI, TSUKUBAMIRAI-SHI, IBARAKI-KEN 300-2493, JAPAN
Phone:+81-297-52-6666
Fax:+81-297-20-5007
E-mail:kaihatsu_6_g3@smcjpn.co.jp

1.3 Contents of operation manual

1) Chap. 1 Introduction

The definition and use of operation manual are described.

2) Chap. 2 Safety Instructions

Safety instruction, caution note, danger and warning, warning label and caution label and safety interlock used in this unit are described.

3) Chap.3 Caution on Installation

The precautions for setting up and mounting this unit are described.

4) Chap. 4 Unit Overview

Describes the outlook of this unit and operation overview.

5) Chap. 5 Names and Functions of Components

The description and function of the parts in this unit are mentioned.

6) Chap. 6 Specifications

The specifications of this unit are described.

7) Chap. 7 Preparation for Operation

The precautions for operation of this unit are described by each part.

8) Chap. 8 Operation

The method for operation of this unit is explained.

9) Chap. 9 Alarm

The alarms, which arise in this unit, are explained.

10) Chap. 10 Appendix

The signal of connectors and the method for calculating dew points are described.

2 Safety Instructions

2.1 Before using the Thermo-con

This chapter is dedicated for your safety during interaction with the product.

The product is operated at high voltage.

Therefore, not only those who operate the unit, but those who are in charge of service and who work nearby the product should read carefully and thoroughly understand descriptions related to safety in this manual before starting the work.

2.1.1 Safety training

This manual is not a general manual for safety and hygiene education that safety and hygiene tutors are supposed to conduct.

Anyone working with or near the product should be fully trained in recognition of the danger inherent to the product and the related safety countermeasures.

A manager is responsible for strict compliance to the safety standard in whole system, but individual person in charge of operation and maintenance should take responsibility for the daily work and should consider the safety of the working location and environment.

Operators and maintenance personnel responsible should ensure the safety of workshops and their environment before starting work.

Training concerning the product should take place after the sufficient training on safety. The training must not be carried without consideration to safety.

2.1.2 Identification of “Danger”, “Warning”, “Caution” and “Note”

The notifications given in this operation manual aim to assure the safe and correct operation of the product to prevent injury of operators or damage to the product. The notifications are grouped into four categories, “Danger”, “Warning”, “Caution”, and “Note”, which indicate the severity of the hazard and damage and also the degree of emergency. All notifications contain critical matter on safety, so they shall be carefully observed.

DANGER, WARNING, CAUTION and NOTE signs are in order according to severity (DANGER> WARNING> CAUTION> NOTE).

Table2-1 Division of DANGER, WARNING, CAUTION, and NOTE





	<p>These paragraphs highlight hazards that would cause serious or even fatal injuries to workers if handled improperly or important instructions are ignored.</p>
	<p>These paragraphs highlights hazards that might cause serious injuries to workers if the appropriate procedure is not carried out or warnings are ignored.</p>
	<p>These paragraphs highlights hazards that might cause serious injuries to workers or might damage the unit, installed devices or products if the appropriate procedure is not carried out or cautions are ignored.</p>
	<p>These paragraphs highlight knowledge which is recommended to be known to avoid mistakes that likely to happen during operation. Also anything that might damage the unit or performance of product for checking is described.</p>

Table2-2 Meaning of symbols

Symbol	IEC/ISO standard	Meaning
	IEC 348	Attention, consult accompanying documents
	ISO 3864, No. B.3.6	Caution, risk of electric shock

2.2 “Warning” label and “Caution” label

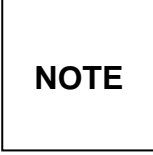
This product is provided with “Warning” labels and “Caution” labels to inform the operator of hazards related to the product. Check the contents and position of all labels before starting the work.

⚠WARNING

The product shall be handled only by trained personnel only. Transportation, installation and maintenance including dangerous work shall be done by persons who have full knowledge and experience on the product and the system. Cover panels of the product shall be opened only by qualified service technicians or qualified personnel.

⚠WARNING

Read all warning and caution labels carefully and keep them in mind. Do not peel off or rub alert warning and caution labels. Confirm locations of alert warning and caution labels.

⚠WARNING

This product cannot be used for the device related to food.

⚠WARNING

If abnormal conditions, such as abnormal noise or smoke, or water leakage appeared, take the following actions:

- Shut down power.
- Stop water radiating water supply
- Contact an authorised SMC dealer for repair

2.2.1 The position of attached “Warning” label and “Caution” label



Fig. 2-1 The position of attaching “Warning” label and “Caution” label

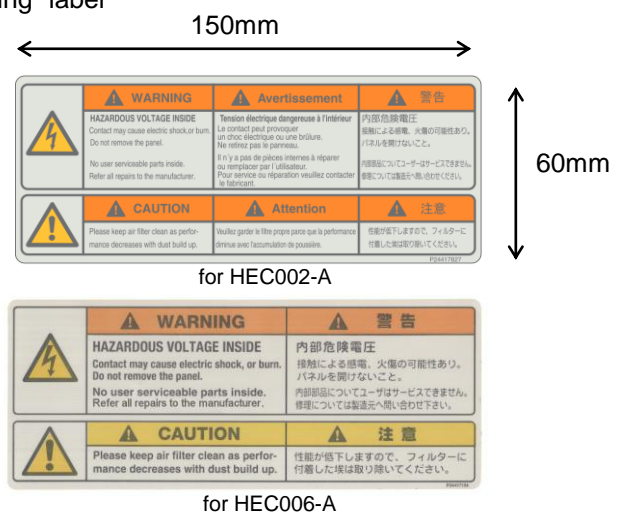

Fig.2-2 Detail of “Warning” and “Caution” label

2.3 Precautions for running (safety interlock)

This is a function to protect personnel, to restrict operation, that may cause damage to the product or facility, and to remove dangers related to safety.

This unit has several interlock functions, which activate when dangerous operation or condition occurs to stop operation and make it safe.

See “2.3.1 Interlock list” for contained function.

▲ DANGER

During operation or maintenance of the product, do not disable the interlock function of any device. Otherwise unexpected personnel injury or damage to the product may occur.

▲ DANGER

When turning on/off the power observe the procedure. Otherwise unexpected malfunction or danger may occur.

When maintaining, cleaning or in case of emergency, turn off the power source.

After identifying a problem be sure to check the cause and take necessary countermeasures before turning on the power.

▲ CAUTION

When the power supply is restarted after turned off once, keep time interval at least 1sec. The restart of supply within that interval may break the unit.

▲ CAUTION

Please do not use the device which generates the electromagnetic radiation such as cellular phones beside the unit. There is a possibility that the unit mis-operates.

2.3.1 Interlock list

Table2-3 Safety interlock list (Part 1)

No.	Description	Part	Quantity	Location	Cause
1	Overheat in Heat Exchanger	Thermostat	1	Heat Exchanger	Detects abnormal heat in heat exchanger.
2	Switching power supply failure	Thermostat	2	Power supply	Detects abnormal current, voltage or heat.
3	Overheat in Heat Sink	Thermostat	1	Heat sink	Detects overheat in Heat Sink.
4	Low circulating fluid level	Level sensor	1	Reservoir	Detects lowering of circulating fluid level in reservoir.
5	Detection of breakage of temp. sensor	Controller internal circuit		-	Detects breakage and short circuit of temp. sensor and cables.
6	Excessive temp. increase	Controller internal circuit		-	Detects temp. input value not less than 70 °C.
7	Excessive temp. decrease	Controller internal circuit		-	Detects temp. input value not more than 0 °C.
8	Abnormal output (Overload)	Controller internal circuit		-	Works when temp. change is smaller than over load detection temp.(selected between 0.1 to 9.9 °C) even if 100% output continues during overload detection time (selected between 0 to 99min.) When 0 is set, the alarm doesn't arise.
9	Low flow rate (Option)	Flow sensor		-	Detects lowering of flow rate at 0.7±0.3L/min or less.

Table2-4 Safety interlock list (Part 2)

No.	Description	Condition of unit	Indication	How to reset
1	Overheat in Heat Exchanger	Shuts off power supply to the Heat exchanger, Pump and Fan.	Error indication on display. (ERR14)	Restart power supply
2	Switching power supply failure	Shuts off power supply to the Heat exchanger, Pump and Fan.	Error indication on display. (ERR11)	Restart power supply
3	Overheat in Heat Sink	Shuts off power supply to the Heat exchanger, Pump and Fan.	Error indication on display. (ERR14)	Restart power supply
4	Low circulating fluid level	Shuts off power supply to the Heat exchanger, Pump and Fan.	Error indication on display. (ERR20)	Restart power supply

5	Detection of breakage of temp. sensor	Shuts off power supply to the Heat exchanger, Pump and Fan.	Error indication on display. (ERR17)	Restart power supply
6	Excessive temp. increase	Shuts off power supply to the Heat exchanger, Pump and Fan.	Error indication on display. (ERR12)	Restart power supply
7	Excessive temp. decrease	Shuts off power supply to the Heat exchanger, Pump and Fan.	Error indication on display (ERR13)	Restart power supply
8	Abnormal output (Overload)	The unit continues to operate.	Error indication on display (ERR15)	Restart power supply
9	Low flow rate (Option)	Shuts off power supply to the Heat exchanger, Pump and Fan.	Error indication on display (ERR16)	Restart power supply

2.4 Disposing of product

Contact an industrial waste disposal company for disposal of the product.

To minimize the risk, drain the fluid from the product when it is scrapped. If the fluid is left inside, an accident and damage can result during transportation.

3 Caution on Installation

▲WARNING

Pay special attention to the safety of all personnel when installing and transporting the product.

▲CAUTION

The product is heavy, be careful when installing or moving the product.

▲CAUTION

Only trained personnel can perform work such as installation, transportation and maintenance of the product.

3.1 Environment

The product shall be installed in an environment that meets the following requirements.

- 1) Where the product is not exposed to water, oil or any chemical spills.
- 2) Where the product is installed horizontally in a stable position .
- 3) Where the product is installed without interfere the suction and discharge port.
- 4) Where the product is not exposed to corrosive or flammable gas. (The unit is not explosion proof.)
- 5) Where the ambient temperature range is between 10 to 35°C and the relative humidity range is between 35 to 80%. No dew condensation is allowed on the unit. Information about due condensation is shown on “10.2 Calculation of Dew Point”.
- 6) Where the product is not exposed to noise sources (such as discharging equipment, large relay and thyristor).
- 7) Where the there is enough space between power supply cable and communication cable of the product and power cables of other equipments.
- 8) Where the product is not exposed to strong electrical or magnetic emissions.
- 9) Where the power supply and ground connections can be made correctly.
- 10) Where the product is not exposed to materials such as silicone, which may generate harmful gas.
- 11) Where the product is not outdoors or in a place with the direct sunshine or heat radiation.
- 12) Where the product is at an altitude of more than 1000 meters.

3.2 Installation

If the air inlet of Thermo-con and the outlet opening is not enough, the cooling capacity decreases due to the rise of the ambient temperature, decrease of the radiating air flow. Install Thermo-con following condition. Moreover, when the exhaust duct is necessary, prepare it by customer.

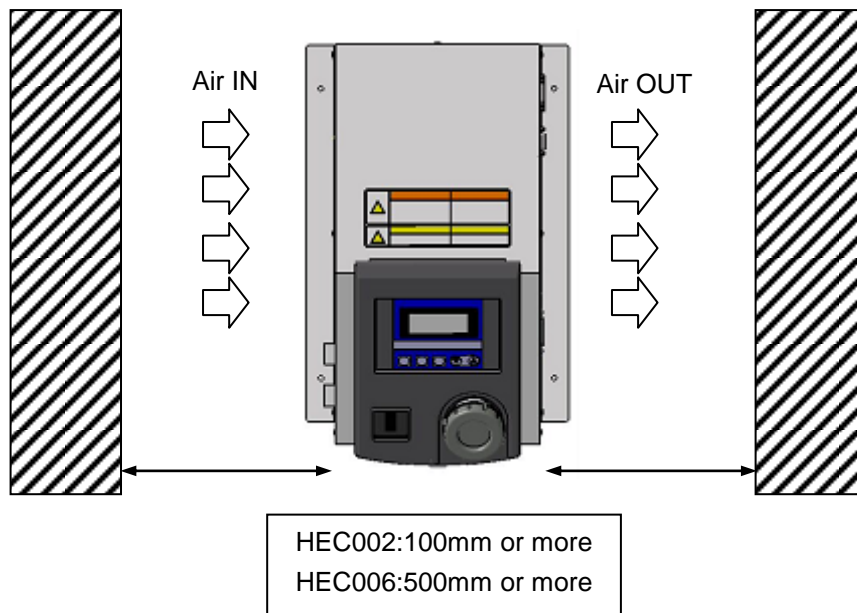

Fig. 3-1 Installation environment

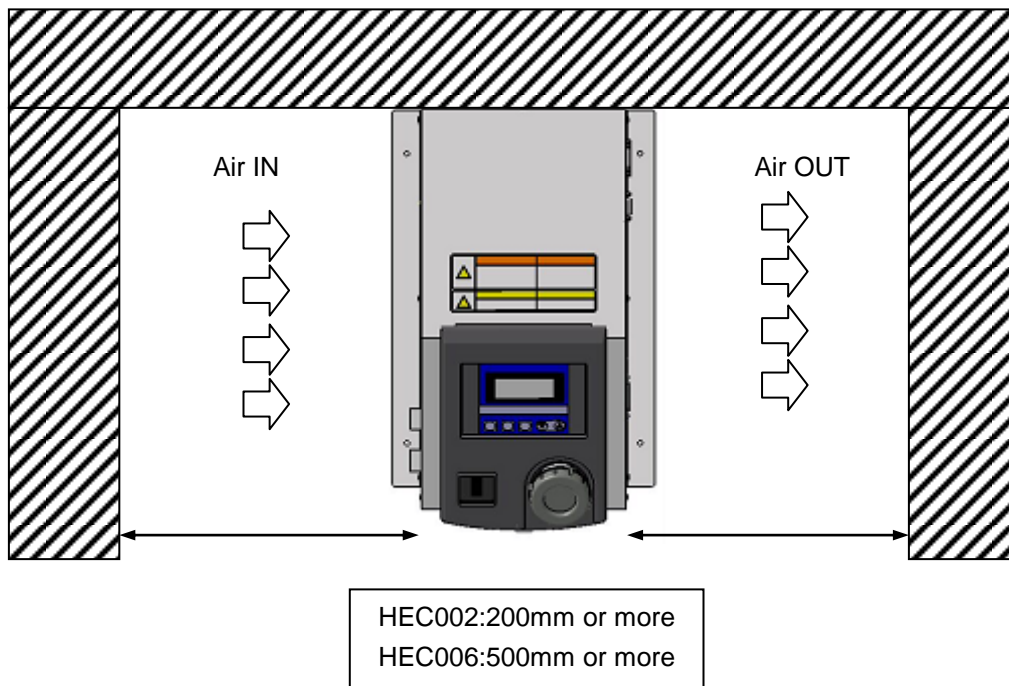

Fig. 3-2 Installation environment (when the back side has been blocked)

3.3 Mounting

The product should be mounted as follows.

- 1) Use the foot attached to the product for mounting.
- 2) Then tighten M4 screws (bolts) or equivalent into 4 holes sized to 5mm on the parts marked with arrow for mounting.

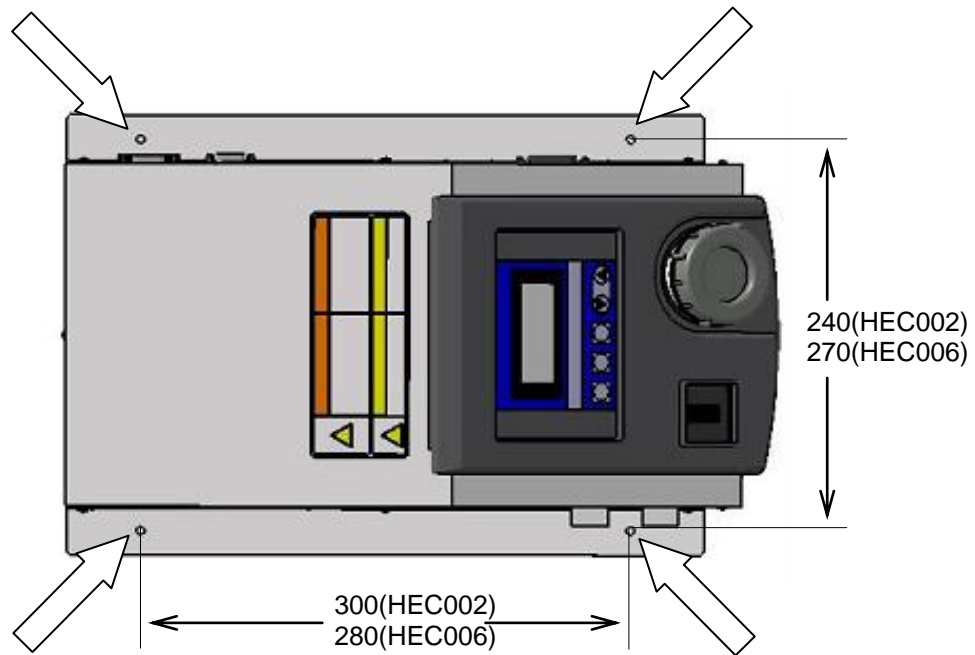

Fig3-3 Mounting

▲ CAUTION

Be sure to correctly tighten all screws the required torque.

3.4 Piping

- 1) Ensure the flow rate of the circulating fluid is as high as possible to maintain the temperature stability. Therefore, the length of the external piping should be minimized and internal diameter should be as large as possible. Piping must have sufficient strength for the maximum discharge pressure of the circulating circuit.
- 2) Likewise, if a tube is bent or multiple elbow fittings are used, the piping resistance will increase and the flow rate will decrease. If the flow rate falls, the temperature stability will decrease.
- 3) If installing a tank externally, only a sealed tank should be used. Do not use an open tank.

▲ CAUTION

Ensure that the INLET and OUTLET for circulating fluid is connected correctly. If any valves are used ensure that they do not restrict the flow, otherwise low flow may cause an alarm.

3.5 Handling

Transport Thermo-con with both handles.

4 Unit Overview

4.1 Method of identifying model

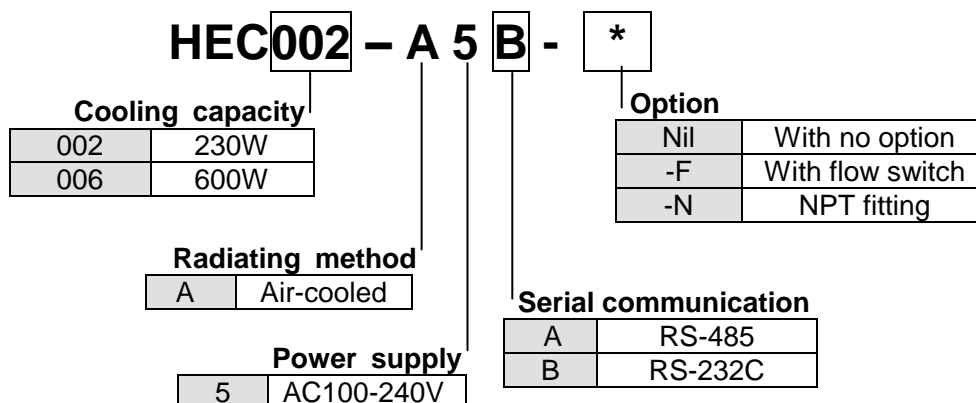

4.2 Manufacturing years method of display

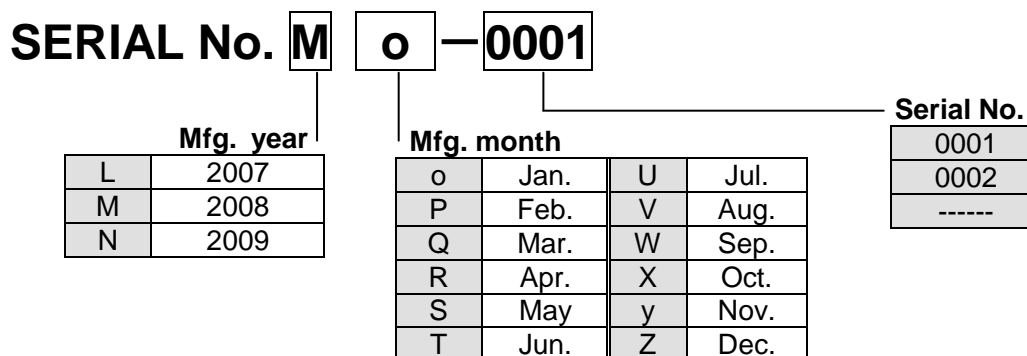

4.3 Model No. label

A model No. label is attached to the unit in the position shown below.

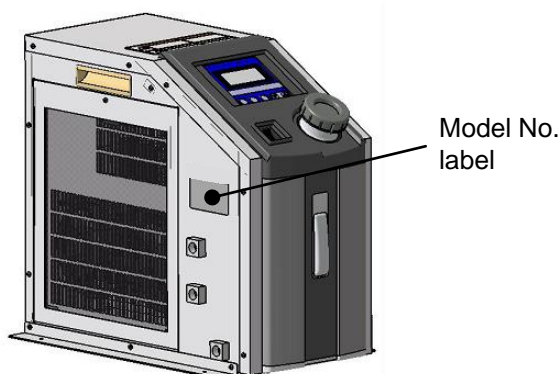

Fig.4-1 Position of Model No. label

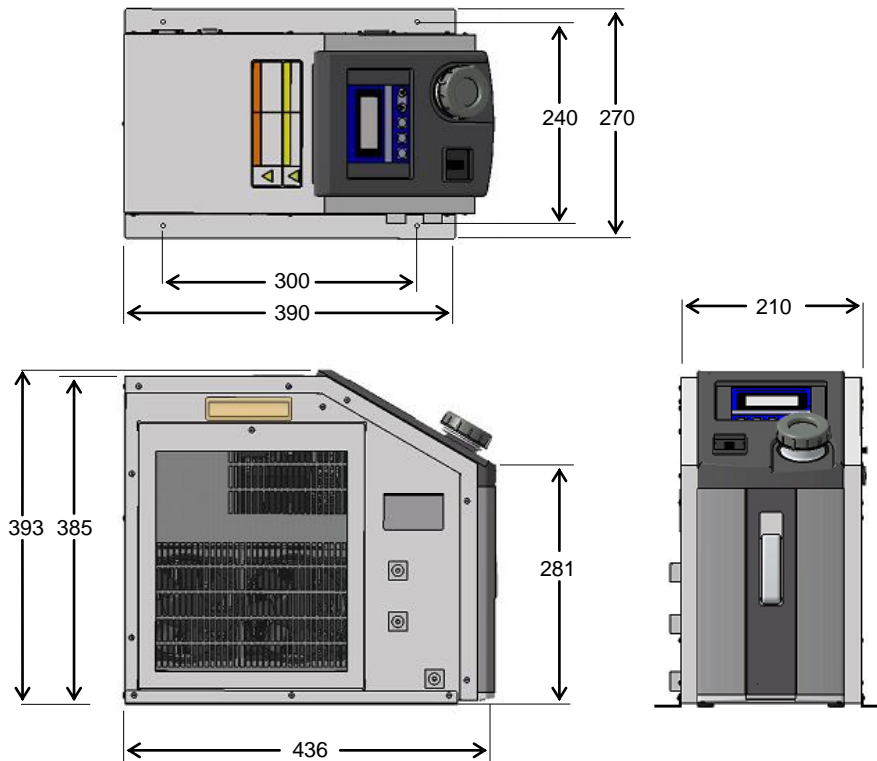

Fig.4-2 Legend of Model No. label

4.4 Appearance

The appearance and the outline dimensions are as shown below.

HEC002-A



HEC006-A

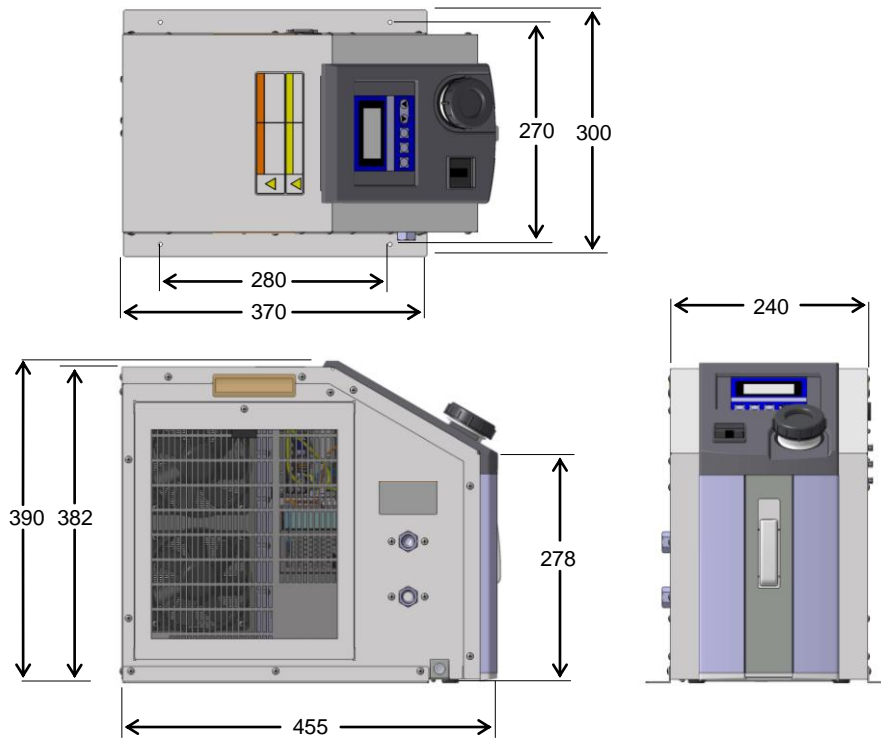

Fig.4-3 Outside drawings of Thermo-con

4.5 Outline of operation

The unit is operated as explained below.

4.5.1 Electrical diagram

The unit is equipped with electrical circuits as shown below.

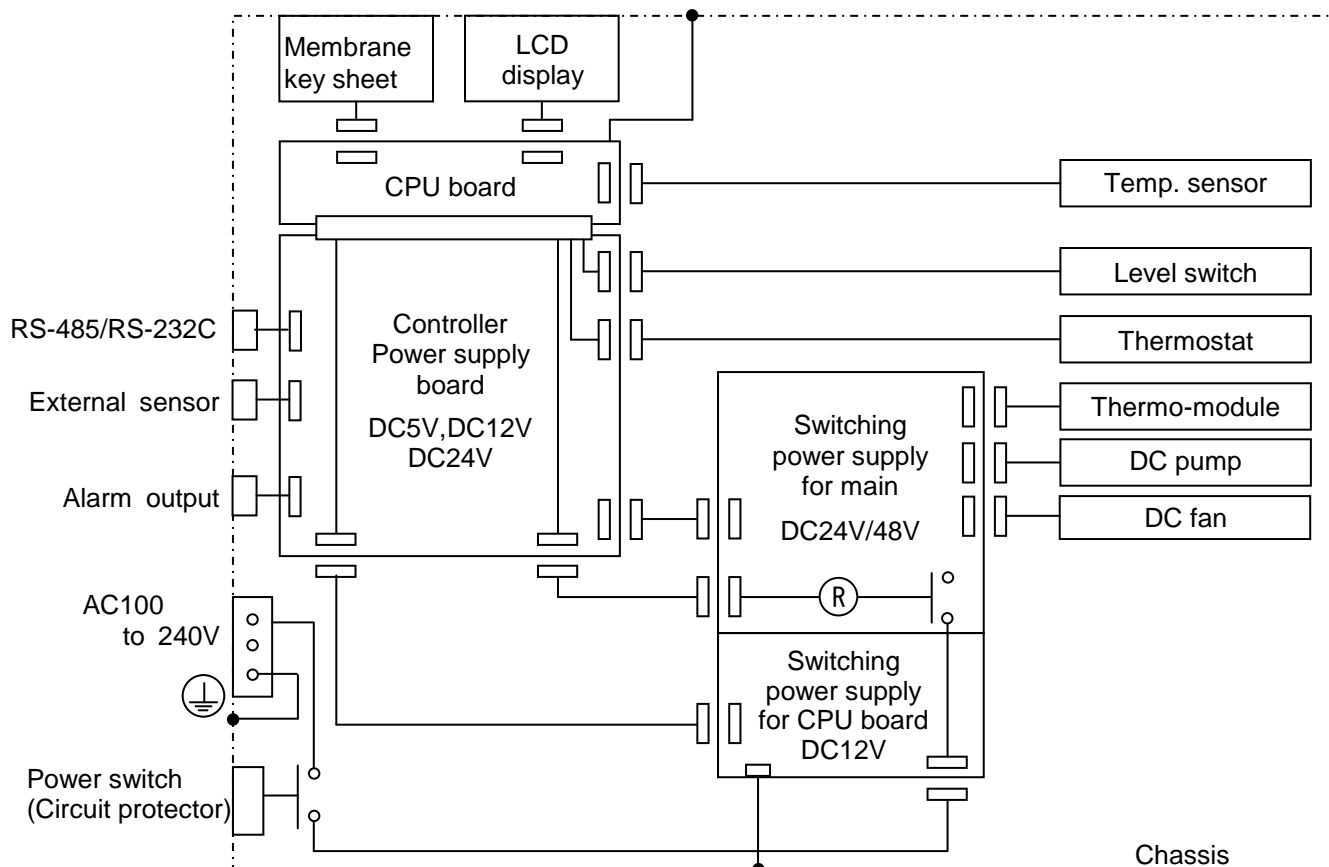

Fig.4-4 Electrical diagram

4.5.2 Mechanical system

The unit is equipped with circulating fluid as shown below.

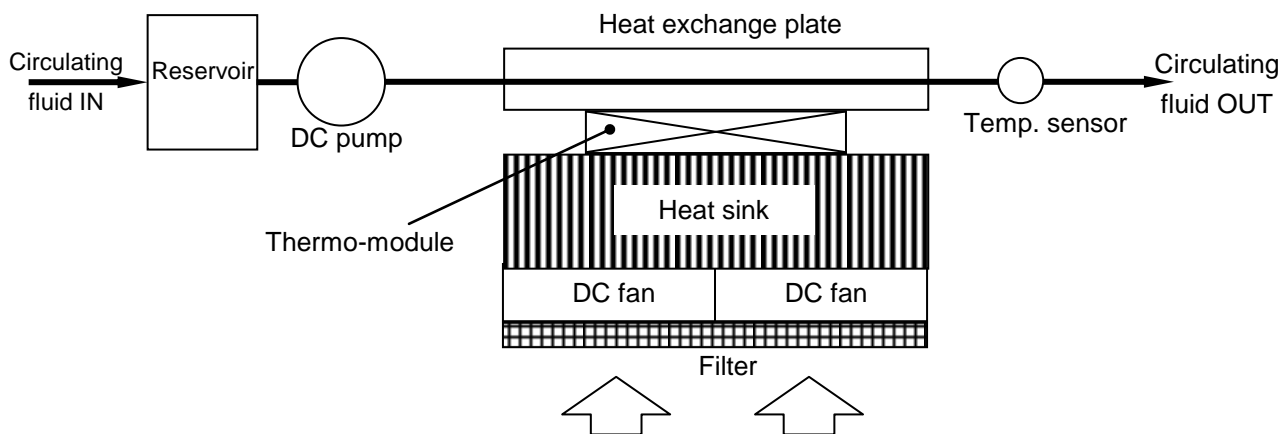

Fig.4-5 Circulating fluid circuit

4.6 Functions

4.6.1 Auto tuning

This function sets the values necessary for the control system such as PID (proportional band, integral time, derivative time and ratio of cooling/ heating gain) automatically.

4.6.2 Offset function

This function controls the temperature slide by an offset value from set point temperature. The range of offset is -9.99 to 9.99 °C. When the circulating fluid is carried to the target object, a certain deviation occurs between the temperature before the object and the setting temperature of the product due to the influence of ambient temperature on the piping. In this case, if the deviation is input as the offset value, the temperature of circulating fluid just before the object can match with setting value.

Internal sensor value for alarm does not include the offset value.

4.6.3 Learning control function

This function lets the product measure the temperature of circulating fluid flowing before temperature target object by an external temperature sensor and adjusts the offset function automatically to the set value at a certain sampling interval. The external temperature sensor needs to be prepared separately by the customer.

4.6.4 External tune control function

This function makes the temperature of circulating fluid consistent to the external (ambient) temperature all the times. This function lets the product measure the temperature from a temperature sensor mounted in the customer preferred location, then it adjusts the temperature of the fluid automatically to the temperature detected by the sensor. The separate temperature sensor needs to be prepared separately by the customer.

4.6.5 Temperature sensor fine control function

This is a function to finely control the measurement temperature of the control sensor within the range of -9.99 to 9.99 °C separate from offset function. Control sensor can be corrected by inputting difference (calibration value) between temperature of standard and that of control sensor.

Internal sensor value for alarm includes the fine control value.

Internal sensor value for alarm = Internal sensor value – Fine control value

4.6.6 Setting value memory function (Function that backs up with EEPROM)

This function backs up all the manually set values to nonvolatile memory (EEPROM). Even if the power is turned off the set values are saved and will be restored at power on.

4.6.7 Upper/ Lower Temperature Limit Alarm Function

This function raises an alarm when temperature of the circulating fluid is out of allowable upper and lower range. When the alarm is raised, WRN is indicated on LCD. If circulating fluid temperature returns to within allowable upper/ lower range, this alarm is automatically canceled. The allowable upper and lower range of temperature can be set between 0.1 and 10 °C.

5 Names and Functions of Components

The parts included into the unit have description and function individually.

5.1 Side view

5.1.1 HEC002

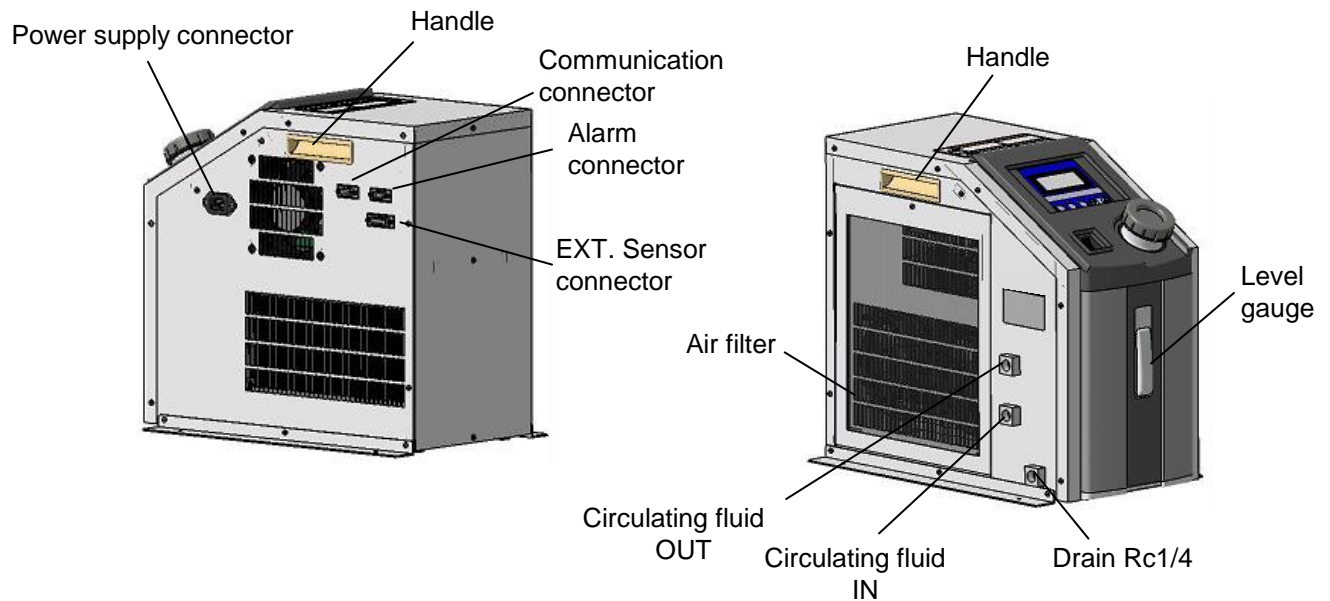

Fig.5-1 HEC002-A

5.1.2 HEC006

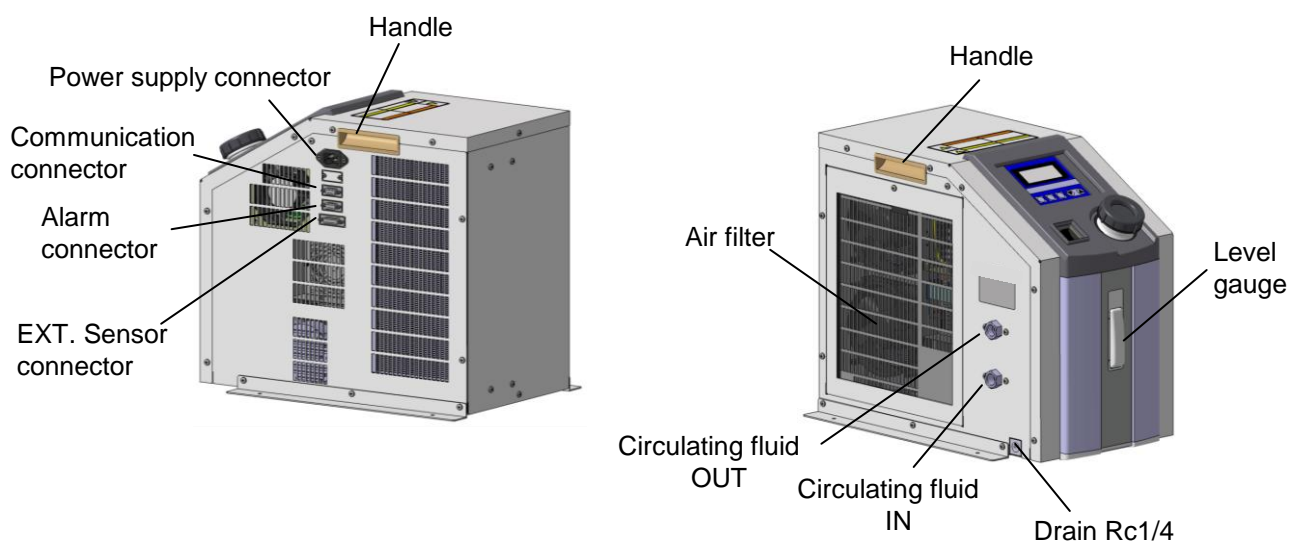

Fig.5-2 HEC006-A

5.1.3 Air Filter

Air Filter

The Thermo-con adopts air-cooled heat exchanger not to allow dust to enter easily inside. However, should the dust be allowed and attached on the filter, the filter may become unable to function properly. To prevent this, the filter should be taken out by removal of circled screws and cleaned periodically.

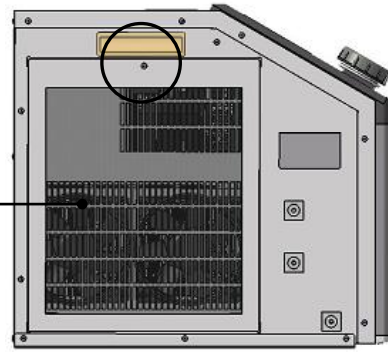

Fig.5-3 Air Filter

▲ CAUTION

**Please keep air filter clean as performance decreases with dust build up.
We will recommend the removal of dust once every three months.
Please remove dust with the cleaner, do not use water to clean.**

5.2 Top view

The parts attached to the top of Thermo-con have description and function individually as shown below.

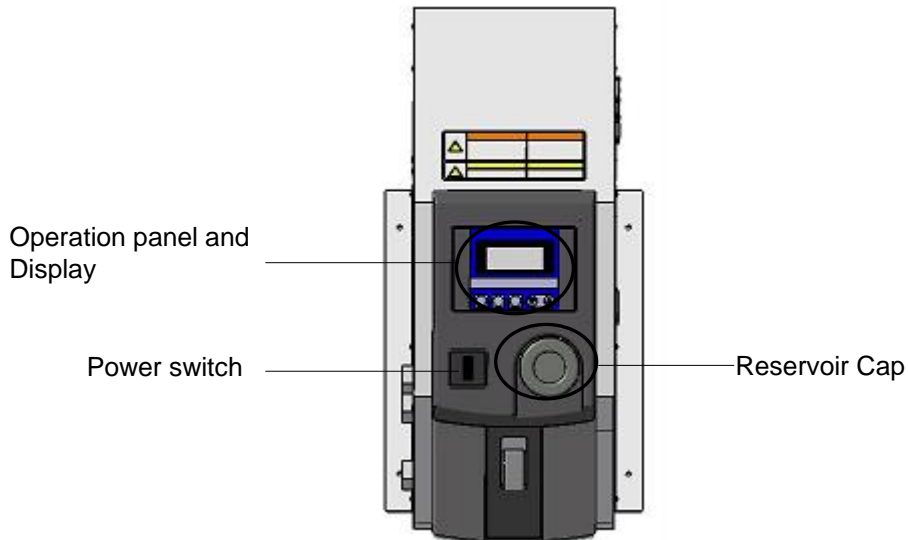

Fig.5-4 Top view

5.2.1 Operation panel

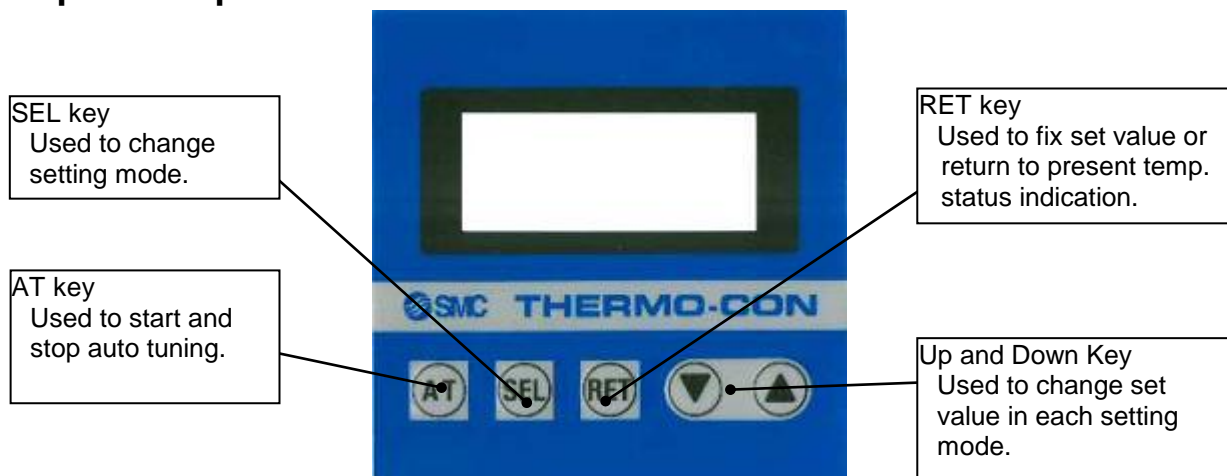

Fig.5-5 Operation panel

5.2.2 Display

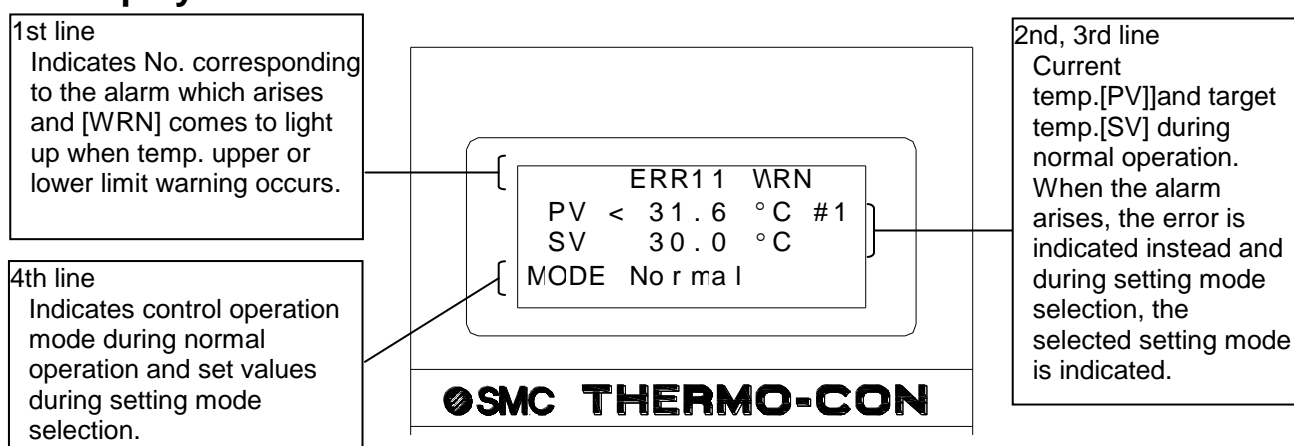

Fig.5-6Display

5.2.3 Reservoir Cap

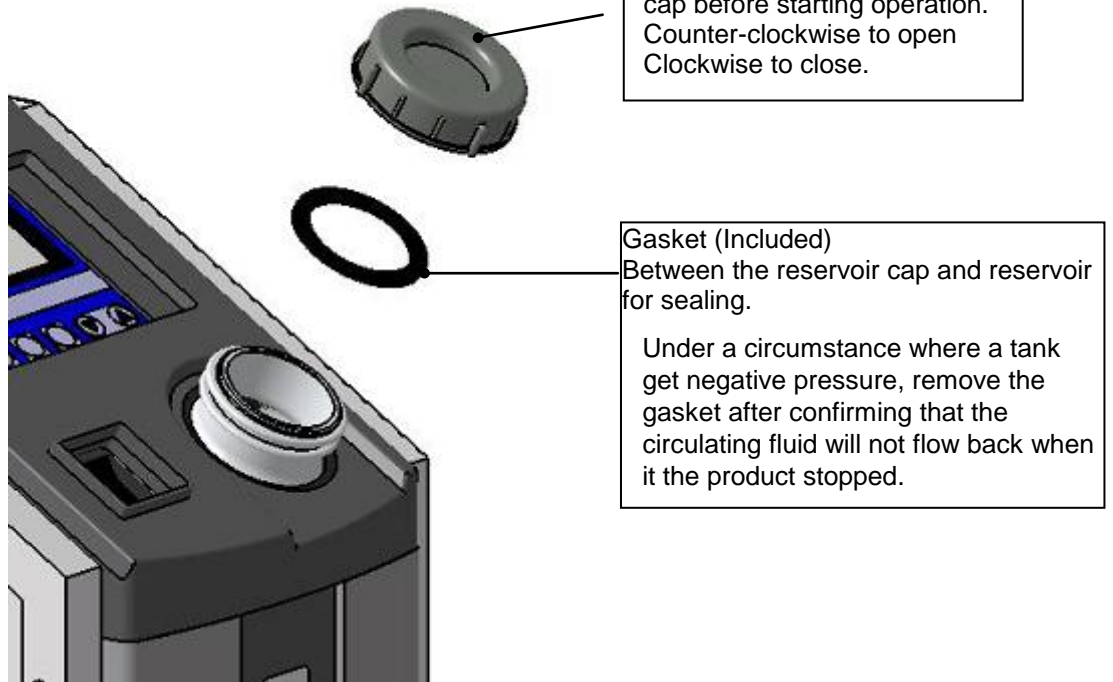
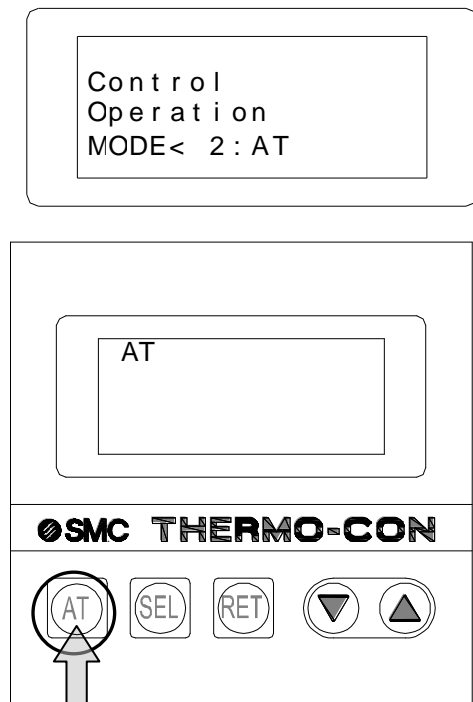

Fig.5-7 Reservoir Cap

5.3 Auto tuning function

If controlled temp. fluctuates constantly after reaching the target temp., perform auto tuning. Controller calculates optimum control PID and set automatically. Auto tuning may require time depending on conditions.

- 1) Select "2" in control operation choices
- 2) Pressing [AT] key to light "AT" indicator and start auto tuning.
- 3) Pressing [AT] key stops auto tuning. ("AT" indicator turns off)
- 4) "AT" indicator turns off when auto tuning completes. If not completed after 20min. [ERR19] (AT abnormal) occurs.
- 5) If auto tuning is no successful, reset to default value, or input the optimum value.



6 Specifications

6.1 Specification table

The specifications of the Thermo-con is as shown below.

6-1 Specifications

Item	Spec.	
Model No.	HEC002-A	HEC006-A
Operation temp. range	10.0 to 60.0 °C (No dew condensation)	
Indication temp. range	-9.9 - 80.0 °C	
Ambient environment	Temp. :10 to 35 °C Humidity : 35 to 80%RH Environment : No corrosive gas, solvent such as thinner and flammable gas	
Storage environment	Temp. :-40 to 70 °C (No dew condensation and icing) Humidity : 5 to 95%RH Environment : No corrosive gas, solvent such as thinner and flammable gas	
Accuracy related to temp.	Indication accuracy: +/- 0.2 °C. Stability: +/- 0.01 to 0.03 °C (Circulating fluid OUT is directly connected with IN)	
Cooling capacity (Water)	Approx.230W (Set temperature25°C and ambient temperature 25°C)	Approx.600W (Set temperature25°C and ambient temperature 20°C)
Circulating fluid	Circulating fluid : Water Reservoir capacity : Approx.1.2L	
Pump	Max. pressure: 0.09MPa	Max. pressure: 0.1MPa
Wetted materials	SUS303, SUS304, EPDM, Ceramic, PPS glass 30%, Carbon Polyethylene, Polyurethane	
Piping port size	Circulating fluid IN/OUT : Rc1/4 Circulating fluid drain : Rc1/4	Circulating fluid IN/OUT : Rc3/8 Circulating fluid drain : Rc1/4
Power supply voltage	Single phase AC100-240V, 50/60Hz	
Current consumption	8A(100V) to 3A(240V)	10A(100V) to 4A(240V)
Inrush current	50A or less	
Over current protection	15A circuit protector	
Insulation resistance	50MΩ or more (DC500V, with surge absorber removed)	
Acoustic noise	55dBA	65dBA
Cooling method	Air cooled	
Main functions	Auto tuning, Off set, Temperature sensor fine control, Temp. upper and lower limit alarm, Output shut off alarm, Serial communication (RS-232C)	
Input operation and indications	Membrane key sheet LCD display panel (with back light)	
Temp. sensor	Resistance thermometer sensor (Pt100Ω, 3-wire, class A, 2mA) (both internal sensor and external sensor)	
Painting color	Urban white	
Mass (at dry)	Approx.17.5kg (with feet)	Approx.27.5kg (with feet)
IP class	IP20 (IEC60529)	

6.2 Performance chart

Value on performance chart is not guaranteed value but representative value. The value used for consideration should not be the very limit for the safety.

1) Cooling capacity

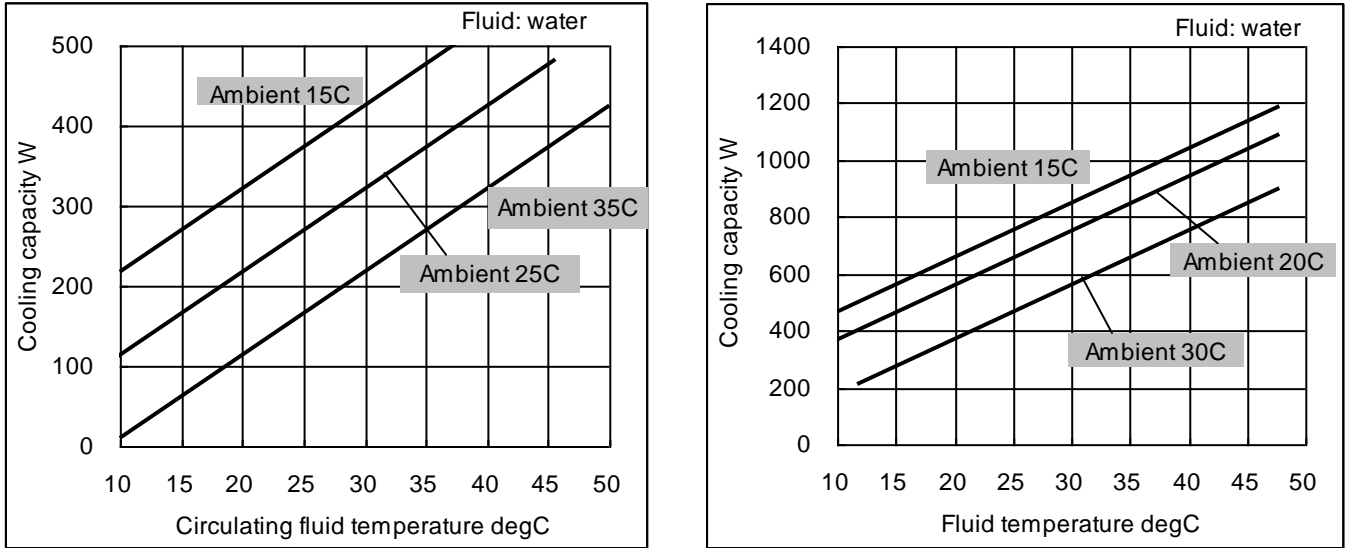

Fig. 6-1 Cooling capacity

2) Heating capacity

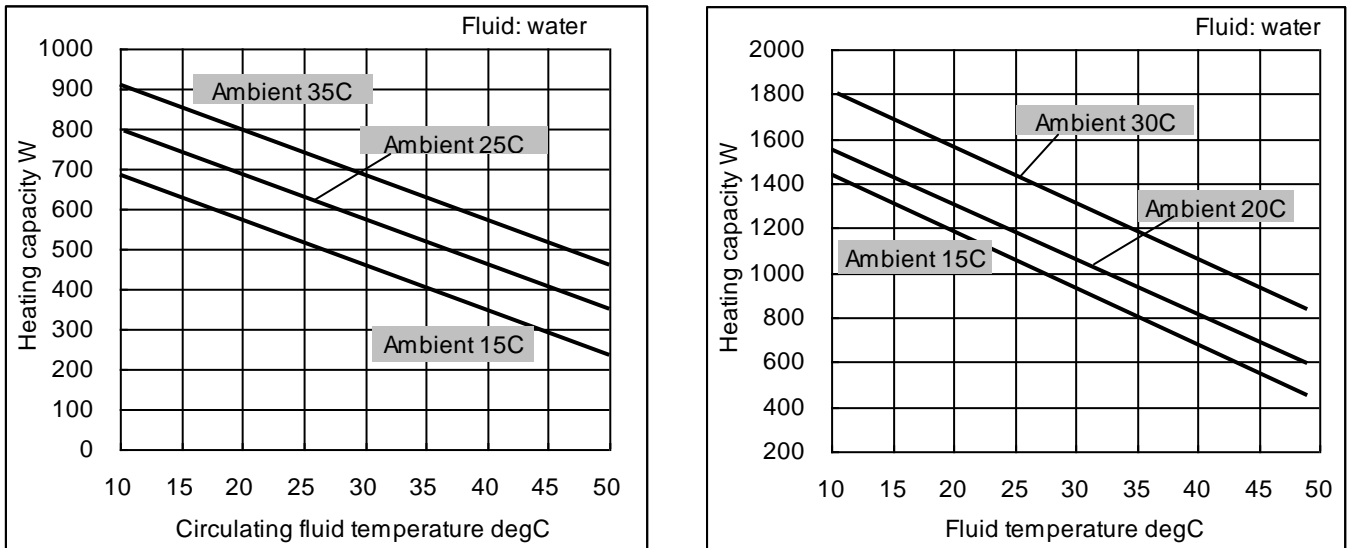
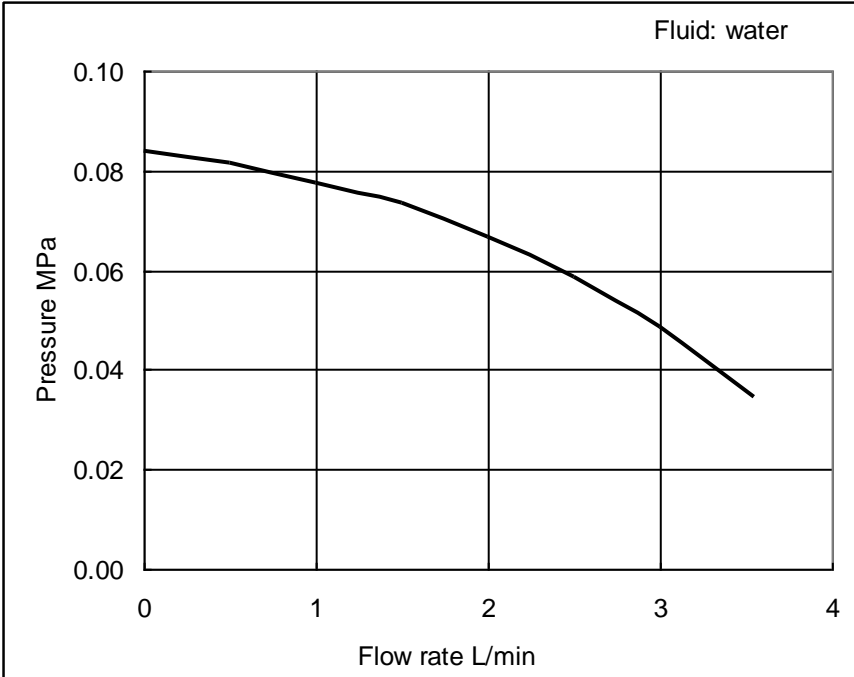

Fig. 6-2 Heating capacity

3) Pump capacity

The pressure on Y axis stands for discharge pressure of circulating fluid from Thermo-con.

HEC002-A



HEC006-A

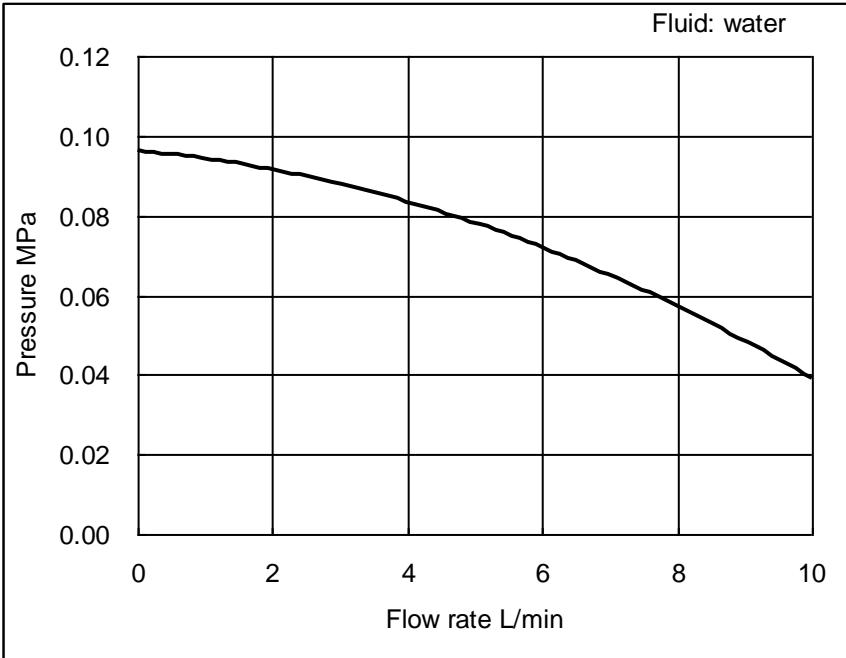

Fig. 6-3 Pump capacity

7 Preparation for Operation

7.1 Preparation for circulating fluid

The piping for circulating fluid is connected as below.

1. The piping for circulating fluid is located at the left side face.
2. The same fittings are used for IN and OUT of the circulating fluid.

The fitting which can mate them needs to be prepared separately. When the fitting is connected, be sure to hold the fitting (block) mounted at Thermo-con with spanner, etc.

Thread size of fitting for circulating fluid:

HEC002-A; Rc1/4

HEC006-A; Rc3/8

A plug is mounted on DRAIN port for circulating fluid. When the piping for drain is connected, remove this plug beforehand.

Drain the circulating fluid before performing any maintenance.

Width across flat of plug: 6mm

DRAIN port size: Rc1/4

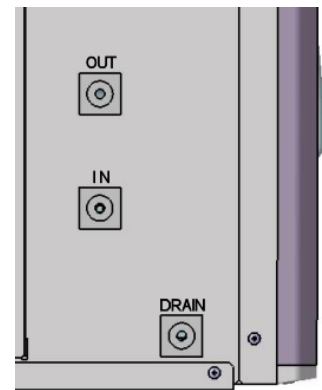

▲ CAUTION

Fluid other than water is not to be used as circulating fluid. Using such a fluid might lead to fluid leakage and damage of the pump.

▲ CAUTION

If a tank released to atmosphere is mounted outside, minimize the piping resistance at RETURN of circulating fluid. If the piping resistance is high, the causing the built-in reservoir of Thermo-con can have negative pressure resulting in deformation and crack. The built-in reservoir of Thermo-con is made of plastic and must not be subject to negative pressure larger than -0.02MPa.

▲ CAUTION

Once the plug is removed from the drain port, the leakage from it is not guaranteed. Therefore, seal it with PTFE seal tape etc. and ensure there is no leakage from it before operation.

7.2 Power supply

The power supply shall be connected with attached power supply cable.

Confirm the power supply at factory has enough capacity and the voltage is within specified value beforehand (with reference to electrical specifications of the power supply). This unit is provided with the power supply cable. The power supply cable shall be connected properly in accordance with Chapter 10 "Power Supply Cable".

Electric specifications of the power supply

AC100-240V, 50/60Hz
Single phase

7.3 Grounding

Be sure to provide the grounding. Use medical plug with protection earth when the unit is used for medical equipment. PE line of the power supply cable is available for grounding. Do not hold the ground in common with the ones for equipment which generates strong electromagnetic noise or high frequency.

7.4 Supply circulating fluid and drain

<Supply circulating fluid>

1. Confirm the power switch is turned off.
2. Take off the reservoir cap of the product.
3. Fill the circulating fluid for the reservoir. The inlet of the reservoir is not so large and there is a possibility of spillage of circulating fluid. Pay attention when filling the circulating fluid.
Stop the filling once the level of fluid reaches "H" level.
4. Turn on the power switch to fill the piping with the fluid.
5. When the piping is filled with the circulating fluid, the level of the reservoir lowers and low circulating fluid alarm (ERR20) arises accordingly. Then, turn off the power supply once again.
6. Repeat the step from 3 to 6 until ERR20 alarm doesn't appear anymore. Then, replace the cap on the reservoir and tighten it securely.
7. Keep the fluid level between H and L of the level indicator.
8. Water pressure during normal operation becomes under 0.1 MPa.

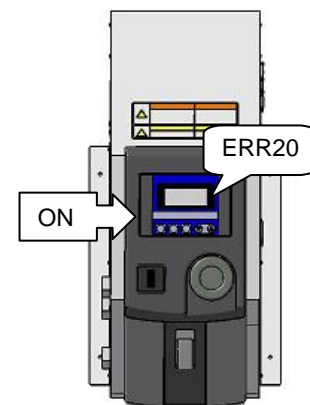
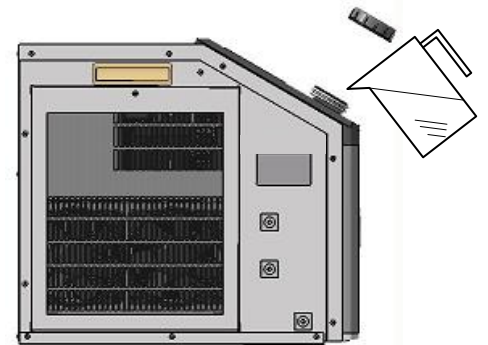

<Drain circulating fluid>

1. Drain circulating fluid from the drain port. Open the reservoir cap would be helpful for draining.
2. To drain from the piping, blow the air (0.1MPa, about 1 minute) from Fluid IN to Fluid OUT. Tighten the tank lid and drain port while blowing

⚠ DANGER

Never touch the switch with wet hands to avoid electrical shock.

▲ CAUTION

Operation of the pump with the plenty of air left in the piping for prolonged period may cause the pump to break. Exhaust the air enough from the piping before starting operation of the pump.

Take enough care not to spill the feed water over the case when supplying water to the reservoir. When it is spilt by mistake, wipe it off immediately and supply the power after it dries. If this procedure is neglected, it may cause breakdown of the equipment.

Do not perform operation under the condition which lowers the flow rate significantly, such as closing the valve. Other wise, the temperature might be beyond control.

▲ CAUTION

If the fluid with low conductivity such as DI water is used as circulating fluid, it causes static electricity due to friction and damages the temperature sensor and other electric components of this unit. Take a measure to minimize static electricity from circulating fluid.

▲ CAUTION

If the power switch is turned on without circulating fluid, the pump is damaged.

▲ CAUTION

The product is damaged when driving for a long term with the temperature staggered periodically after reaching the target temperature. Please set the PID value again by using auto-tuning function (see section 5.3).

7.5 Check·Repair

The following checks shall be performed before operation.

7.5.1 Daily check

- 1) Indication of display panel : Check temperature condition and confirm whether or not the alarm occurs.
- 2) Filter : Confirm there is not attachment of the dust on the filter at suction port. A lot of attachment may impair performance. We will recommend the removal of dust once every three months.
- 3) Confirm there is no leakage of circulating fluid or no bending or crush of the piping of circulating fluid.
- 4) Confirm there is no abnormal sound or smell or abnormal heating of the case.

▲ CAUTION

Remove the dust attached to a filter by vacuum cleaner to prevent degrading of performance. The recommended interval of removal is once per 3 months. Do not use water or boiled water since it leads to generation of rust at a frame.

7.5.2 Check after seismic vibration and impact

- 1) Piping: Confirm there is no defect including disconnection in piping.
- 2) Electrical wiring: Confirm there is disconnection of the connector from the cable.
- 3) Mounting condition: If the Thermo-con is mounted for operation, confirm the Thermo-con is mounted securely.
- 4) Circulating fluid: Confirm there is no leakage.
- 5) Others: Confirm there is no abnormal sound or smell or abnormal heating of the case.

7.5.3 Repair and maintenance

The repair and maintenance services of this unit are performed only at our factory. The service requiring a trip regardless of inside and outside of Japan is not provided. Also, when this unit is returned for these purposes, drain the fluid from Thermo-con.

Additionally, it is recommended to prepare spare units to minimize downtime due to those repair and maintenance services.

▲ WARNING

Drain the fluid from Thermo-con when it is returned for the repair and maintenance service. If the fluid is left inside, an accident and damage can result during transportation.

▲ CAUTION

After washing with DI water, return the product when the fluid was other than water. The acceptance might be refused according to the state of the product.

8 Operation

This chapter describes the detailed information on how to operate.

8.1 Condition after power up

1. Indication of software version

When power is turned on, software version is indicated on display panel for approx. 1 sec.

(Ex. : 1.0)

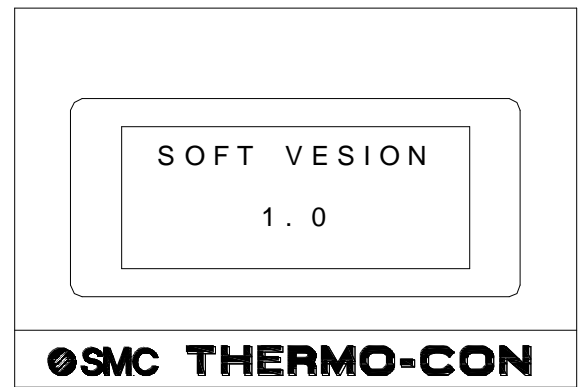

⚠ CAUTION

Please do not use devices that generate electromagnetic radiation such as cellular phones near the product. There is a possibility that the product malfunctions.

8.2 How to operate

1. The different 3 levels are available depending on the content, which needs to be set.

Level 1 : Used in normal operation. Setting of target temp. and offset are included.(→ Refer to 8.3.)

Level 2 : Used at maintenance and initial setting and the setting of controller PID is included.(→ Refer to 8.4.)

Level 3 : Used rarely for the purpose other than initial setting and communication setting is included.(→ Refer to 8.5)

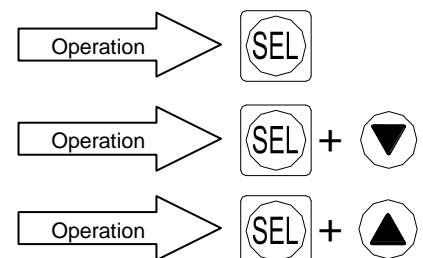

2. [SEL] key

Used to show the item, which needs to be changed in selected mode level.

3. [∇ Δ] key (up/down key)

Used to change the value of the item shown by [SEL] key.

4. [RET] key

Used to fix the value changed by [∇ Δ]key. Press once again to return to current temp. indication.

5. [AT] key

Used to start auto tuning in auto tuning mode (control operation mode : 2). When pressed during auto tuning, the auto tuning is stopped. (→ Refer to 5.3)

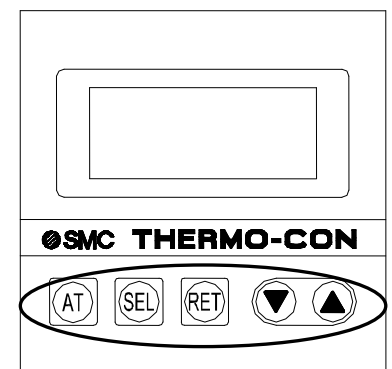

8.3 Setting Mode, Level 1

The method to enter to and return from setting mode Level 1 and which mode can be set in the level are explained below.

8.3.1 How to enter and return

Press [SEL] key while power is turned on. Then, the indication on [MODE] is changed depending on the number of press and the data in the indicated mode can be set. To return to current temperature indication, press [RET] key.

NOTE

When no input is done within 1 minute regardless of setting mode, the current temperature indication is returned automatically.

8.3.2 Available mode in Level 1

The mode which can be set in setting mode Level 1 is as shown on Table 8-1. The mode available in Level 1 is supposed to be used in normal operation including target temp. and offset.

NOTE

The inputted data is written in EEPROM and memorized after the power supply is turned off. The writing can be done up to 1 million times.

Table8-1 Available mode in Level 1

No.	Modes	Setting contents	Setting range (Min. increment)	Default
1	Target Temp. (No indication on display)	Sets target temp. for control.	10.0 to 60.0 °C (0.1 °C)	25.0
2	Control Operation	Selects control operation mode from those shown below. 0 : Pump stop(No control) 1 : Normal(normal control operation) 2 : AT(auto tuning) 3: Learn (learning control) 4: External (external tune control)	0,1,2,3,4	1
3	External Sensor Sampling Cycle	Sets sampling cycle for learning control or external tune control. (Not indicated during normal control.)	10 to 999sec (1sec)	180
4	Offset Value	Indicates the offset value of the circulating fluid temperature used as reference value by the controller (SV + Offset).	-9.99 to 9.99 °C (0.01 °C)	0.00
5	Allowable Upper Temp. Range	Sets upper limit of temp. range which causes the warning to arise.	0.1 to 10.0 °C (0.1 °C)	1.5
6	Allowable Lower Temp. Range	Sets lower limit of temp. range which causes the warning to arise.	0.1 to 10.0 °C (0.1 °C)	1.5

7	High Temp. Cutoff	Sets upper limit of temp. which the internal temp. sensor detects and judges the unit should be shut off.	11.0 to 70.0 °C (0.1 °C)	70.0
8	Low Temp. Cutoff	Sets lower limit of temp. which the internal temp. sensor detects and judges the unit should be shut off.	0.0 to 59.0 °C (0.1 °C)	0.0

* How to return default value: Turn on the power supply with pressing [SEL] and [RET] keys,. At this time, the settings of Level 2 and Level 3 are also reset.

8.4 Setting mode, Level 2

The method to enter to and return from setting mode Level 2 and which mode can be set in the level are explained below.

8.4.1 How to enter and return

Press [SEL] and [▽] keys at the same time while power is turned on. Then, the indication on [MODE] is changed depending on the number of press and the data in the indicated mode can be set. To return to current temp. indication, press [RET] key twice.

NOTE

When no input is done within 1 minute regardless of setting mode, the current temperature indication is returned automatically.

8.4.2 Available mode in Level 2

The mode, which can be set in setting mode Level 2, is as shown on Table 8-2. The mode available in Level 2 is supposed to be used normally for initial setting and maintenance and control PID is included.

NOTE

The inputted data is written in EEPROM and memorized after the power supply is turned off. The writing can be done up to 1 million times.

Table8-2 Available mode in Level 2

No.	Modes	Setting contents	Setting range (Min. increment)	Default
1	Fine Control of Internal Sensor	Sets the fine adjusting value to calibrate the internal temp. sensor.	-9.99 to 9.99 °C (0.01 °C)	0.00
2	Fine Control of External Sensor	Sets the fine adjusting value to calibrate the external temp. sensor available optionally.	-9.99 to 9.99 °C (0.01 °C)	0.00
3	PB Range	Sets PB (Proportional Band) range used for PID control.	0.3 to 9.9 °C (0.1 °C)	0.6 (2.0)
4	ARW Range	Sets integral operation range of PID control. ARW: Anti Reset Windup	0.3 to 9.9 °C (0.1 °C)	1.0 (2.2)
5	I Constant	Sets integral time used for PID control.	1 to 999sec (1sec)	150 (50)
6	D Constant	Sets differential time used for PID control. When 0 is set, differential operation is not made.	0.0 to 99.9sec (0.1sec)	0.0
7	Heating/Cooling Ratio	Sets output ratio of cooling to heating to compensate difference of gain between them.	10 to 999% (1%)	200
8	Overload Judging Temp. Range	Sets the temp. range for judgment of overload(accompanying abnormal output alarm ERR15).	0.1 to 9.9 °C (0.1 °C)	0.2
9	Overload Judging Time	Sets time for judgment of overload (accompanying abnormal output alarm ERR15). When 0 is set, the alarm doesn't arise.	0 to 99min (1min)	10
10	Output Ratio	Shows output ratio of thermo module by 1%. The prefix symbol "-" stands for cooling and no prefix stands for heating.	-100 to 100% (1%)	-
11	Upper/Lower Temp. Alarm Sequence	Determines whether or not temp. upper/lower limit alarm is output when power is turned on. On : Output Off : Not output	On,Off	Off

* How to return default value: Turn on the power supply with pressing [SEL] and [RET] keys. At this time, the settings of Level 1 and Level 3 are also reset.

* The default value indicated in () is an optimal value. The value is inputted at that time of shipment factory. If turn on the power supply with pressing [SEL] and [RET] keys, set up the value indicated in ().

8.5 Setting mode, Level 3

The method to enter to and return from setting mode Level 3 and which mode can be set in the level are explained below.

8.5.1 How to enter and return

Press [SEL] and [Δ] keys at the same time while power is turned on. Then, the indication on [MODE] is changed depending on the number of press and the data in the indicated mode can be set. To return to current temp. indication, press [RET] key twice.

NOTE

When no input is done within 1 minute regardless of setting mode, the current temperature indication is returned automatically.

8.5.2 Available mode in Level 3

The mode, which can be set in setting mode Level 3, is as shown on Table 8-3. The mode available in Level 3 is supposed not to be used normally for the purpose other than initial setting and the setting related to communication is included.

NOTE

The inputted data is written in EEPROM and memorized after the power supply is turned off. The writing can be done up to 1 million times.

Table8-3 Available mode in Level 3

No.	Modes	Setting contents	Setting range (Min. increment)	Default
1	Unit Number	Sets the unit No. used. This is applicable only when multiple Thermocon is used.	0 to F (Hex decimal)	0
2	Baud Rate	Sets baud rate for communication.	600,1200,2400,4800 9600,19200b/s	1200
3	Parity Bit	Sets parity bit for communication. Without : No parity Odd : Odd Even : Even	Without, Odd, Even	Without
4	Data Length	Sets data length for communication.	7Bits, 8Bits	8
5	Stop Bit	Sets stop bit for communication.	1Bit, 2Bits	1

* How to return default value: Turn on the power supply with pressing [SEL] and [RET] keys. At this time, the settings of Level 1 and Level 2 are also reset.

8.6 Detail of setting mode level

The each setting mode level is explained below in detail.

8.6.1 Setting mode, Level 1

1. Indication of current temperature [PV]

Indication range: -9.9 to 80.0 °C

Min. increment: 0.1 °C

Indicated content: #1 Temperature detected by internal temp. sensor

#2 Temperature detected by external temp. sensor

(When the external sensor is not connected, "HHH" would be indicated.)

#1 and #2 change when [△] or [▽] is pressed.

```
P V < 23.0°C # 1
S V   25.0°C
M O D E
```

```
P V < 23.0°C # 2
S V   25.0°C
M O D E
```

2. Target temperature (no indication on display)

Setting range : 10.0 to 60.0 °C

Min. increment : 0.1 °C

Indicated content : [SV] : Target temp.(Ex. : 25.0 °C)

Function : Sets target temperature

```
P V      23.0°C # 1
S V <   25.0°C
M O D E
```

3. Control Operation

Setting range : 0,1,2,3,4

Indicated content : Number and description of control operation mode.(Ex. : 1:Normal)

Function : Selects control operation mode from those shown below.

0 : Stop of control (Pump Stop)

1 : Normal (normal control operation)

2 : AT (auto tuning)

3 : Learning control (Learn)

4 : External tune control (External)

```
C o n t r o l
O p e r a t i o n
M O D E < 1 : N o r m a l
```

When a learning control and an external tuning control are selected, measurement temperature (#2) of an external temperature sensor is displayed.

When an external tuning control is selected, the target temperature is changed at any time. When the control mode changes from external tune mode to normal mode, the target temperature returns to the previous value.

<How to perform auto tuning>

1) Select "2" in control operation.

2) Press [AT] key to light up "AT" indicator. The auto tuning starts.

3) To stop auto tuning, press [AT] key again. ("AT" indicator goes off.)

4) When auto tuning is finished, "AT" indicator goes off. If the auto tuning is not finished within 20min, [ERR19] (AT error) arises.

5) If the auto tuning fails, change the PID values to the set values at the time of shipment from factory or input the optimum values.

4. External sensor sampling cycle setting mode

[External sensor sampling cycle]

Setting range: 10 to 999sec

Min. increment: 1sec

Indicated content: External sensor sampling cycle

(Ex.: 180sec)

Function: Sets sampling cycle of external sensor for learning control or external tune control.

```
E x t e r n a l   S e n s o r
S a m p l i n g   C y c l e
M O D E < 1 8 0   s e c
```

5. Offset Value

Setting range : -9.99 to 9.99 °C

Min. increment : 0.01 °C

Indicated content : Offset value(Ex. : -0.15 °C)

Function : It allows the change of the difference between the controller reference value and set value by offset.

For example, if -0.15 °C is set here, the actual reference temperature for control is lower than the indicated SV by 0.15 °C.

```
Offset Value
MODE< -0.15 °C
```

6. Allowable Upper Temp. Range

Setting range : 0.1 to 10.0 °C

Min. increment : 0.1 °C

Indicated content : Temp. from target to upper limit
(Ex.: 1.5 °C)

Function : Sets upper limit of temp. where the warning arises. The difference between target temp. and upper limit temp. should be input. Therefore, if the target temp. is 23.0 °C and 1.5 °C is set in this item, the warning [WRN] arises when temp. exceeds 24.5 °C.

```
Allowable Upper
Temp. Range
MODE< 1.5 °C
```

7. Allowable Lower Temp. Range

Setting range : 0.1 to 10.0 °C

Min. increment : 0.1 °C

Indicated content : Temp. from target to lower limit
(Ex. : 1.5 °C)

Function : Sets lower limit of temp. where the warning arises. The difference between target temp. and lower limit temp. should be input. Therefore, if the target temp. is 23.0 °C and 1.5 °C is set in this item, the warning [WRN] arises when temp. lowers 21.5 °C.

```
Allowable Lower
Temp. Range
MODE< 1.5 °C
```

8. High Temp. Cutoff

Setting range : 11.0 to 70.0 °C

Min. increment : 0.1 °C

Indicated content : High temp. cutoff by internal temp. sensor (Ex. : 70.0 °C).

Function : Sets upper limit of temp. at which the internal temp. sensor detects and judges the unit should be shut off. When the temp. set in this item is reached, the alarm [ERR12] arises.

```
High Temp.
Cutoff
MODE< 70.0 °C
```

9. Low Temp. Cutoff

Setting range : 0.0 to 59.0 °C

Min. increment : 0.1 °C

Indicated content : Low temp. cutoff by internal temp. sensor (Ex. : 0.0 °C)

Function : Sets lower limit of temp. at which the internal temp. sensor detects and judges the unit should be shut off. When the temp. set in this item is reached, the alarm [ERR13] arises.

```
Low Temp. Cutoff
MODE< 0.0 °C
```

8.6.2 Setting mode, Level 2

1. Fine Control of Internal Sensor
Setting range : -9.99 to 9.99 °C

Min. increment : 0.01 °C

Indicated content : Fine adjusting value for internal temp. sensor (Ex. : -0.07 °C)

Function : Sets the fine adjusting value to calibrate the internal temp. sensor. If -0.07 °C is set in this item, the reading of temp. sensor is higher by 0.07 °C and actually, the temp. is controlled to lower one by 0.07 °C.

```
Fine Control of
Internal Sensor
MODE< -0.07 °C
```

2. Fine Control of External Sensor
Setting range : -9.99 to 9.99 °C

Min. increment : 0.01 °C

Indicated content : Fine adjustment value for external temp. sensor(Ex. : 0.05 °C)

Function : Sets the fine adjusting value to calibrate the external temp. sensor if it is mounted optionally. If 0.05 °C is set in this item, the reading of temp. sensor is lower by 0.05 °C and actually, the temp. is controlled to higher one by 0.05 °C.

```
Fine Control of
External Sensor
MODE< 0.05 °C
```

3. PB Range

Setting range : 0.3 to 9.9 °C

Min. increment : 0.1 °C

Indicated content : PB range(Ex. : 2.0 °C)

Function : Sets PB (Proportional Band) range used for PID control.

```
PB Range
MODE< 2.0 °C
```

4. ARW Range

Setting range : 0.3 to 9.9 °C

Min. increment : 0.1 °C

Indicated content : ARW range (Ex.: 2.2 °C)

Function : Sets integral operation range of PID control. If this value is set less than PB range, the set temperature can't be achieved. Therefore set it above PB range.

```
ARW Range
MODE< 2.2 °C
```

ARW: Anti Reset Windup

5. I Constant

Setting range : 1 to 999sec

Min. increment : 1sec

Indicated content : I constant(Ex. : 50sec)

Function : Sets integral time used for PID control.

```
I Constant
MODE< 50 °C
```

6. D Constant

Setting range : 0.0 to 99.9sec

Min. increment : 0.1sec

Indicated content : D constant(Ex. : 0.0sec)

Function : Sets differential time used for PID control.

When 0 is set, this function becomes invalid.

```
D Constant
MODE< 0.0 sec
```

7. Heating/Cooling Ratio

Setting range : 10 to 999%

Min. increment : 1%

Indicated content : Heating/cooling gain ratio(Ex. : 200%)

Function: Sets output ratio of cooling to heating to compensate difference of gain between them.

```
Heating / Cooling
Ratio
MODE< 200 %
```

8. Overload Judging Temp. Range

Setting range : 0.1 to 9.9 °C

Min. increment : 0.1 °C

Indicated content : Overload judging temp. range (Ex. : 0.2 °C)

Function : Sets the temp. range for judgment of product overload (accompanying abnormal output alarm ERR15).

```
Overload / Judging
Temp. Range
MODE< 0.2 °C
```

9. Overload Judging Time

Setting range : 0 to 99min

Min. increment : 1min

Indicated content : Overload judging time(Ex. : 10min)

Function : Sets time for judgment of product overload (accompanying abnormal output alarm ERR15). When 0 is set, the alarm doesn't arise.

```
Overload Judging
Time
MODE< 10 min
```

10. Output indication mode [Output Ratio]

Setting range : -100 to 100%

Min. increment : 1%

Indicated content: Thermo module output ratio (Ex.: -73%)

Function: Indicates Thermo module output ratio with increment of 1%. "+" is not indicated but "+" means heating and "-" means cooling.

```
Output Ratio
MODE< - 73 %
```

11. Upper/Lower Temp. Alarm Sequence

Setting range : On, Off

Indicated content : Use of temp. upper/lower limit alarm sequence(Ex. : Off)

Function : Determines whether or not temp. upper/lower limit alarm is output when power is turned on.

On : Output

Off : Not output (Alarm for high and low temperature limit is not detected until the temperature reaches the target temperature after the power is supplied.)

```
Upper / Lower Temp.
Alarm Sequence
MODE< Off
```

8.6.3 Setting mode, Level 3

1. Unit Number

Setting range : 0-F (Hex decimal)

Indicated content : Unit number (Ex. : 0)

Function : Sets unit number used. This item is applicable only when multiple units are used.

```
Unit Number
MODE< 0
```

2. Baud Rate

Setting range : 600, 1200, 2400, 4800, 9600, 19200b/s

Indicated content : Baud rate (Ex. : 1200b/s)

Function : Sets baud rate for communication.

```
Baud Rate
MODE< 1200b/s
```

3. Parity Bit

Setting range : Without (no parity), Odd, Even

Indicated content : Parity bit (Ex. : Without)

Function : Sets parity bit for communication.

```
Parity Bit
MODE< Without
```

4. Data Length

Setting range : 7Bits, 8Bits

Indicated content : Data length(Ex. : 8Bits)

Function : Sets data length for communication.

```
Data Length
MODE< 8 Bits
```

5. Stop Bit

Setting range : 1Bit,2Bits

Indicated content : Stop bit(Ex. : 1Bit)

Function : Sets stop bit for communication.

```
Stop Bit
MODE< 1 Bit
```

9 Alarm

This chapter explains the various alarms that the product has.

9.1 How to Identify Alarm

The alarm is identified as shown on the following table.

Table9-1 Alarm information

No.	Condition	After Alarm Occurrence	Indication example
1	Power supply on	After indication of the software version, the error No.[ERR**] starts blinking and then a description of the error is displayed, and [MODE], "Shut Off" is shown. ("Continuity" is shown instead for ERR15 and ERR18 occurs because the product continues to operate.)	Fig.9-1
2	Normal operation	The value of PV and SV disappear and instead, the error No. [ERR**] starts blinking and the a description of the error is displayed, and [MODE], "Shut Off" is shown. ("Continuity" is shown instead when ERR15 and ERR18 occurs because the product continues to operate.)	
3	Set value input	Even during input of a setting, the error No. [ERR**] starts blinking on the upper line. After input (pressing [RET] key to set), a description of the error is displayed (see Fig.9-1).	Fig.9-2
4	Temp. upper/lower limit alarm occurrence	The value of PV and SV and the indication of [MODE] remain but also [WRN] lights up. After the error is reset, the indication of [WRN] disappears	Fig.9-3

9.2 Alarm indication

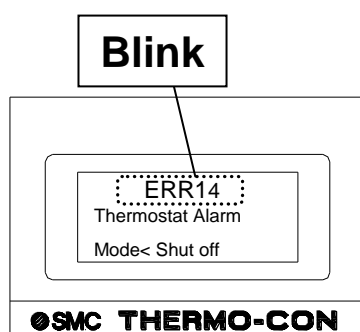

Fig.9-1 Alarm indication in the event ERR14 arises

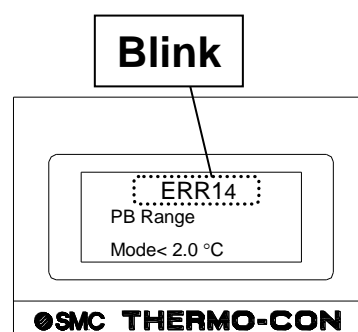

Fig.9-1 Alarm indication in the event ERR14 arises during PB range setting input

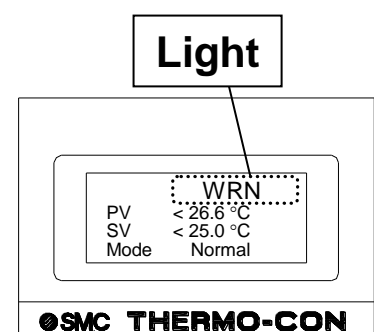

Fig.9-3 Alarm indication in the event temp. upper and lower limit arises

9.3 How to reset alarm

The alarm can be reset in the following manner.

Table9-2 Reset of alarm

No.	Alarm code	Description	Manner of reset
1	ERR00	CPU hang-up	Restart the power supply. In this case if the alarm can't be reset by above manner, repair is required.
2	ERR01	CPU check error	
3	ERR03	EEPROM wiring error	Initialization of EEPROM or stop and restart the power supply In this case if the alarm can't be reset by above manner, repair is required.
4		Others	Removal of possible cause and restart the power supply In this case if the alarm can't be reset by above manner, repair is required.

9.4 Alarm code list

The alarm has individual code sent from controller as listed below.

Table9-3 Alarm code list

Code	Description	Contents
WRN	Temp. upper/lower limit	Condition : Fluid temp. is out of limit range. After alarm occurrence : The product continues operating and returns normal condition if the temperature goes back within range. Indication : [WRN] indicator lamp lights up.(Fig9-3)
ERR00	CPU hung-up	Condition : CPU hang-up due to noise etc. After alarm occurrence : The product and communication stop. Indication : [Hung-up of CPU]
ERR01	CPU check failure	Condition : The data of CPU can't be read correctly when the power supply is turned on. After alarm occurrence : The product and communication stop. Indication : [CPU Check Failure]
ERR03	Back-up data error	Condition : The contents of back-up data can't be read correctly when power is turned on. After alarm occurrence : The product and communication stop. Indication : [Back-up Data Error]
ERR04	EEPROM writing error	Condition : EEPROM doesn't allow writing of the data. After alarm occurrence : The product and communication stop. Indication : [EEPROM Writing Error]

Code	Description	Contents
ERR11	DC power supply failure	Condition : Switching power supply has a problem (The fan stops and temperature is excessively high.) or Thermo-module is short circuited. After alarm occurrence : The product (temp. control, pump, fan) stops. Indication : [DC Power Voltage Failure]
ERR12	High temp. cutoff.	Condition : Fluid temp. goes higher than high temp. cutoff setting. Default : 70.0 °C After alarm occurrence : The product (temp. control, pump, fan) stops. Indication : [Internal Sensor Value is High]
ERR13	Low temp. cutoff.	Condition : Fluid temp. becomes lower than low temp. cutoff setting. Default : 0.0 °C After alarm occurrence : The product (temp. control, pump, fan) stops. Indication : [Internal Sensor Value is Low]
ERR14	Thermostat Alarm	Condition : The thermostat is operated due to clogging of the filter or breakdown of fan or pump, etc. Thermostat working temp. : 60±5 °C (heat sink) 80±5 °C (at circulating fluid side) After alarm occurrence : The product (temp. control, pump, fan) stops. Indication : [Thermostat Alarm]
ERR15	Abnormal output	Condition : Temperature change is less than overload judging temp. range even by 100% output for overload judging time period due to application of unacceptable heat load or broken wire of Thermo-module. Default : 0.2 °C 10min After alarm occurrence : The product continues controlling except that output failure alarm is shown. Indication : [Output Failure Alarm]
ERR16	Low circulating flow rate (Option)	Condition : The flow rate of the circulating fluid is low.. Set flow rate: 0.7L/min After alarm occurrence : The product (temp. control, pump, fan) stop. Indication : [Flow Alarm]
ERR17	Breakage of internal temp. sensor	Condition : The internal temp. sensor is broken or disconnected. After alarm occurrence : The product (temp. control, pump, fan) stop. Indication : [Cutoff/Short of Internal Sensor]
ERR18	Disconnection of external temp. sensor	Condition: The external temp. sensor is disconnected or not mounted. (This condition is detected only in learning control or external tune control.) After alarm occurrence : The product continues controlling. Indication : [Cutoff/Short of External Sensor]
ERR19	Abnormal auto tuning	Condition : The auto tuning could not finish within 20min. After alarm occurrence : The product (temp. control, pump, fan) stop. Indication : [AT Failure]
ERR20	Low fluid level	Condition : The level of circulating fluid in the reservoir is low. After alarm occurrence : The product (temp. control, pump, fan) stop. Indication : [Low Fluid Level Alarm]

9.5 Troubleshooting

Troubleshooting methods when the alarm appears is explained as follows.

Table9-4 Troubleshooting

Code	Reason for alarm setting	Cause
ERR00	(1) High level noise on the power line, ground line, or temp. sensor line.	(1) Move the product to an environment with little noise, turn ON the power supply. If there is no alarm, it was caused by noise. Please consult with us.
ERR01	(1) High level noise on the power line, ground line, or temp. sensor line.	(1) Move the product to an environment with little noise, turn ON the power supply. If there is no alarm, it was caused by noise. Please consult with us.
ERR03	(1) The EEPROM data was destroyed by high level noise.	(1) Move the product to an environment with little noise, turn ON the power supply. If there is no alarm, it was caused by noise. Please consult with us.
ERR04	(1) Controller EEPROM data has been corrupted due to high level noise. (2) Writing frequency to EEPROM exceeds product guarantee value (1,000,000 times).	(1)(2)Request a repair if the alarm can't be reset.
ERR11	(1) DC output voltage of product is reduced. (2) The fan at the power supply stops. (3) The large amount of dust is attached to the filter. (4) Voltage sag happens.	(1) Check the power voltage is 100 to 240VAC (2) Remove foreign matters which might stop the fan. (3) The inside of the power supply can get hot. Eliminate the dust on the filter. (4) If voltage sag lasts over specified value of 50msec, the output of DC power supply reduces and the alarm occurs. Ensure that voltage sag does not happen.
ERR12	(1) Internal temp. sensor value exceeds the high temp. cutoff temperature. (2) Flow rate of circulating fluid is zero.	(1) Check the set value for high temp. cutoff temperature and confirm the temperature really reaches this value. (2) If the flow rate of the circulating fluid is zero, the temperature of circulating fluid can't be detected and might increase. Confirm the flow of circulating fluid isn't stopped by valves etc.
ERR13	(1) Internal temp. sensor value is lower than low temp. cutoff temperature. (2) Flow rate of circulating fluid is zero.	(1) Check the set value for low temp. cutoff temp. and confirm the temperature really reaches this value. (2) If the flow rate of the circulating fluid is zero, the temperature of circulating fluid can't be detected and might increase. Confirm the flow of circulating fluid isn't stopped by valves etc.
ERR14	(1) Ambient temp is high. (2) Dust is stuffed on filter. (3) Flow rate is zero. (4) The pump breaks. (5) The fan fails.	(1) Decrease ambient temp. (2) Eliminate dust on the filter. (3)(4) If flow rate of circulating fluid is zero, the temperature of circulating fluid can't be measured and the temperature of heat exchanger may increase. Ensure the circulating fluid is allowed to flow. (5) Confirm the fan for radiating thermo module is working.

ERR15	(1) Cooling or heating capacity overload. (2) Volume of circulating fluid is too large.	(1) If PV temp. changes when the set temp. is raised and down, it causes overload. (2) If the volume of circulating fluid system is too large, the change of temperature takes a long time. In this case, change overload judging time setting to avoid this alarm. (Refer to 8.6.2.9)
ERR16 (option)	(1) The flow rate of the circulating fluid is 1 L/min. or less. (2) The Thermo-controller is faulty.	(1) Investigate why the flow rate of the circulating fluid is low and take countermeasures (2) Replace the Thermo-con with a new one, and check if it is broken. SMC can repair faulty controllers.
ERR17	(1) High level noise entered the temp. sensor line.	(1) Check the temperature unstable occurred by noise. Please consult us if it causes noise.
ERR18	The external temp. sensor is not mounted.	For learning control or external tune control, be sure to mount the external temp. sensor.
ERR19	Capacity of circulating fluid is too large.	Adjust PID value (proportional band, ARW value, integral time and derivative time) of setting mode Level 2 by hand.
ERR20	(1) Fluid level of reservoir is not enough. (2) Fluid is leaking.	(1) Refill fluid. (2) Check all fluid connections connected with the product.
Temperature rises and falls +/-1 to 2 °C gradually about the set point temperature.	(1) Flow rate of circulating fluid is low. (2) PID parameters are wrong value.	(1) Keep the flow rate 1L/min(HEC002), 3L/min(HEC006) or more. (2) If the temperature can't be stable at default value, perform auto tuning.

10 Appendix

The signal and shape of each connector and the method to calculate dew point are explained below.

10.1 Signal and style of connectors

The signal and style of each connector attached to the Thermo-con are as shown on the table below.

Table10-1 Signal and style of connectors

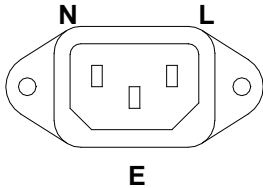
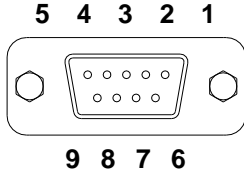
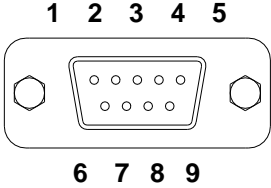
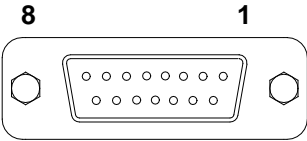
Description	No.	Signal		Style and Part No.
Power supply connector (IEC60320)	N	AC100-240V		
	L	AC100-240V		
	E	PE		
Communication connector (RS-232C) socket 1pcs		RS-232C	RS-485	 <p>D-sub 9 pin (socket type) Fixed screw: M2.6</p>
	1	Unused	BUS +	
	2	RXD (RD)	BUS -	
	3	TXD (SD)	Unused	
	4	Unused	Unused	
	5	SG	SG	
	6-9	Unused	Unused	
Alarm Output connector	1	Output Cutoff Alarm a contact (OPEN During Alarm)		 <p>D-sub 9 pin (Pin type) Fixed screw: M2.6</p>
	2	Output Cutoff Alarm Common		
	3	Output Cutoff Alarm b contact (CLOSE During Alarm)		
	6	Temperature Alarm a contact (OPEN During Alarm)		
	7	Temperature Alarm Common		
	8	Temperature Alarm b contact (CLOSE During Alarm)		
External temperature sensor connector	3	Resistance Bulb Terminal A		 <p>D-sub 15 pin (Socket type) Fixed screw: M2.6</p>
	4	Resistance Bulb Terminal B		
	5	Resistance Bulb Terminal B		
	15	FG		

10.2 Calculation of dew point (from psychrometric chart)

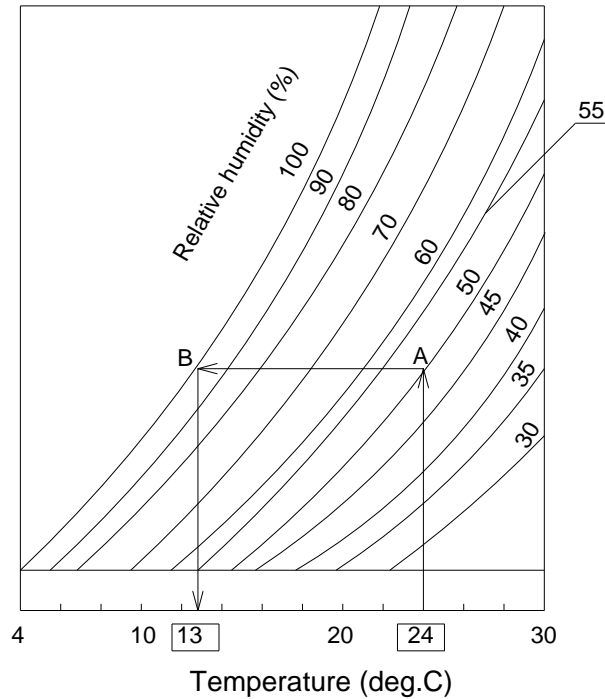

Fig.10-1 Moisture air diagram

- 1) Measure the ambient temperature and relative humidity.
- 2) Plot the ambient temperature on the horizontal axis (Ex. 24 °C), and then draw a perpendicular line.
- 3) Find the intersection (A) of the curve, which is equal to relative humidity (Ex. 50%).
- 4) Draw a line from point (A) parallel to horizontal axis, and find the intersection (B) of the curve for 100% relative humidity.
- 5) Draw a perpendicular line from the intersection at point (B) down to the horizontal axis and read the Dew Point Temperature. (13 °C in this case.)

*Therefore, moisture in the air starts to condensate when the air temperature becomes lower than this temperature.

10.3 Power Supply Cable

Table 10-2 Power Supply Cable

Description	Specifications
Connector	Rating Voltage: 250V Rating Current: 10A
Cable	Rating Voltage: 300V AWG14

⚠ CAUTION

Do not use the included power supply cable for any purposes other than connection to this product.

Revision history

SMC Corporation

4-14-1, Sotokanda, Chiyoda-ku, Tokyo 101-0021 JAPAN

Tel: + 81 3 5207 8249 Fax: +81 3 5298 5362

URL <http://www.smcworld.com>

Note: Specifications are subject to change without prior notice and any obligation on the part of the manufacturer.
© 2018 SMC Corporation All Rights Reserved