

# Before Use

## Fieldbus device

### EX260 Series for POWERLINK

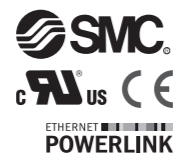

Thank you for purchasing an SMC EX260 Series Fieldbus device (Hereinafter referred to as "SI unit"). Please read this manual carefully before operating the product and make sure you understand its capabilities and limitations. Please keep this manual handy for future reference.

To obtain the operation manual about this product and control unit, please refer to the SMC website (URL <http://www.smcworld.com>) or contact SMC directly.

## Safety Instructions

These safety instructions are intended to prevent hazardous situations and/or equipment damage. These instructions indicate the level of potential hazard with the labels of "Caution", "Warning" or "Danger". They are all important notes for safety and must be followed in addition to International standards (ISO/IEC) and other safety regulations.

- Caution:** CAUTION indicates a hazard with a low level of risk which, if not avoided, could result in minor or moderate injury.
- Warning:** WARNING indicates a hazard with a medium level of risk which, if not avoided, could result in death or serious injury.
- Danger:** DANGER indicates a hazard with a high level of risk which, if not avoided, will result in death or serious injury.

## Operator

- ◆ This operation manual is intended for those who have knowledge of machinery using pneumatic equipment, and have sufficient knowledge of assembly, operation and maintenance of such equipment. Only those persons are allowed to perform assembly, operation and maintenance.
- ◆ Read and understand this operation manual carefully before assembling, operating or providing maintenance to the product.

## Safety Instructions

### Warning

- Do not disassemble, modify (including changing the printed circuit board) or repair. An injury or failure can result.
- Do not operate the product outside of the specifications. Do not use for flammable or harmful fluids. Fire, malfunction, or damage to the product can result. Verify the specifications before use.
- Do not operate in an atmosphere containing flammable or explosive gases. Fire or an explosion can result. This product is not designed to be explosion proof.
- If using the product in an interlocking circuit:
  - Provide a double interlocking system, for example a mechanical system.
  - Check the product regularly for proper operation.
  - Otherwise malfunction can result, causing an accident.
- The following instructions must be followed during maintenance:
  - Turn off the power supply.
  - Stop the air supply, exhaust the residual pressure and verify that the air is released before performing maintenance.
  - Otherwise an injury can result.

### Caution

- After maintenance is complete, perform appropriate functional inspections. Stop operation if the equipment does not function properly. Safety cannot be assured in the case of unexpected malfunction.
- The surface on the product may be hot.
- Provide grounding to assure the noise resistance of the Fieldbus system. Individual grounding should be provided close to the product with a short cable.

## NOTE

- ◆ When conformity to UL is necessary the SI unit must be used with a UL1310 Class 2 power supply.

## Summary of Product element

<EX260-SPL1/-SPL3>

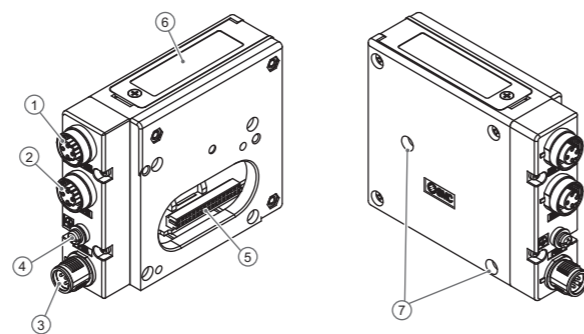

No.	Element	Description
1	Fieldbus interface connector (BUS OUT/Port2)	POWERLINK connection PORT 2 (M12 4-pin socket, D-coded)
2	Fieldbus interface connector (BUS IN/Port1)	POWERLINK connection PORT 1 (M12 4-pin socket, D-coded)
3	Power supply connector	Power supply with load voltage for valves and operating voltage for SI unit (M12 5-pin plug, A-coded)
4	Ground terminal	Functional earth (M3 screw)
5	Output connector	Output signal interface for valve manifold
6	LED	Bus status-specific and SI unit-specific LEDs
7	Mounting hole	Mounting hole for connection to the valve manifold

Accessories

Hexagon socket head cap screw	2 pcs. M3 x 30 screw for connection to the valve manifold
Seal cap	1 pc. seal cap for unused fieldbus interface connector (BUS OUT)

## Connecting cables

Select the appropriate cables to mate with the connectors mounted on the SI unit.

### Fieldbus interface connector layout

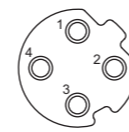

BUS OUT: M12 4-pin socket D-coded (SPEEDCON)

No.	Designation	Description
1	TD+	Transmit Data +
2	RD+	Receive Data +
3	TD-	Transmit Data -
4	RD-	Receive Data -

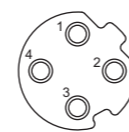

BUS IN: M12 4-pin socket D-coded (SPEEDCON)

No.	Designation	Description
1	TD+	Transmit Data +
2	RD+	Receive Data +
3	TD-	Transmit Data -
4	RD-	Receive Data -

The M12 connector cable has two types, SPEEDCON compatible and non-compatible. If both plug and socket sides have connectors for SPEEDCON, the cable can be inserted and connected by turning it a 1/2 of a rotation, leading to reduction in work hour. A non-compatible connector can be connected to a compatible connector as well as an M12.

### Power supply connector layout

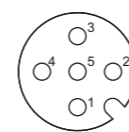

PWR: M12 5-pin plug A-coded (SPEEDCON)

No.	Designation	Description
1	SV24 V	+24 V for solenoid valve
2	SV0 V	0 V for solenoid valve
3	SI24 V	+24 V for SI unit operation
4	SI0 V	0 V for SI unit operation
5	-	Unused

The M12 connector cable has two types, SPEEDCON compatible and non-compatible. If both plug and socket sides have connectors for SPEEDCON, the cable can be inserted and connected by turning it a 1/2 of a rotation, leading to reduction in work hour. A non-compatible connector can be connected to a compatible connector as well as an M12.

### Ground terminal

Connect the ground terminal to ground. Resistance to ground should be 100 ohms or less.

### Output number assignment

Output numbering starts at zero and refers to the solenoid position on the manifold.

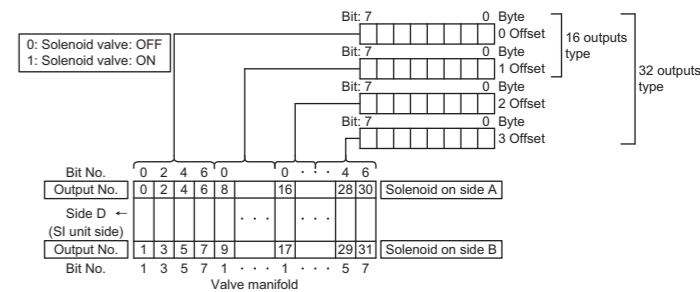

## LED indication



LED	Status	Description
S/E	<input type="checkbox"/> OFF	SI unit operating voltage is not supplied.
	<input checked="" type="checkbox"/> Green flashing	POWERLINK communication has not been established. Fast flashing (note 1): Basic Ethernet state Single flash (note 2): Pre-Operational 1 Double flash (note 3): Pre-Operational 2 Triple flash (note 4): Ready to operate Slow flashing (note 5): Stopped
	<input checked="" type="checkbox"/> Green ON	POWERLINK communication has been established.
	<input checked="" type="checkbox"/> Red ON	POWERLINK communication has been separated or Node ID set outside range.
	<input type="checkbox"/> OFF	SI unit operating voltage is not supplied.
ST	<input checked="" type="checkbox"/> Green ON	Operating normally.
	<input checked="" type="checkbox"/> Red ON	SI unit has failed.
L/A1	<input type="checkbox"/> OFF	BUS IN side: No Link, No Activity
	<input checked="" type="checkbox"/> Green ON	BUS IN side: Link, No Activity
L/A2	<input checked="" type="checkbox"/> Green flashing	BUS IN side: Link, Activity
	<input type="checkbox"/> OFF	BUS OUT side: No Link, No Activity
L/A2	<input checked="" type="checkbox"/> Green ON	BUS OUT side: Link, No Activity
	<input checked="" type="checkbox"/> Green flashing	BUS OUT side: Link, Activity
PWR(V)	<input checked="" type="checkbox"/> Green ON	Load voltage for the valve is supplied.
	<input type="checkbox"/> OFF	Load voltage for the valve is not supplied or is outside tolerance range (19 V or less).

Note 1: ON/OFF 50 ms flashing  
Note 2: ON 200 ms single flash, OFF 1 s  
Note 3: ON/OFF 200 ms double flash, OFF 1 s  
Note 4: ON/OFF 200 ms triple flash, OFF 1 s  
Note 5: ON/OFF 200 ms flashing

## Installation

### General instructions on installation and maintenance

Connect valve manifold to the SI unit. Refer to the EX260 series valve manifold section in the valve catalogue for valve manifold dimensions.

### Assembly and disassembly of the SI unit

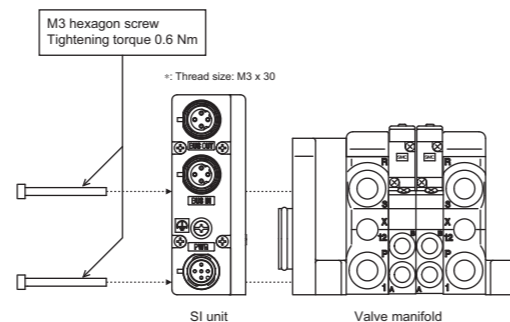

### Replacement of the SI unit

- Remove the M3 hexagon screws from the SI unit and release the SI unit from the valve manifold.
- Replace the SI unit.
- Tighten the screws with the specified tightening torque. (0.6 Nm)

### Precautions for maintenance

- Be sure to switch off the power.
  - Check there is no foreign matter inside the SI unit.
  - Check there is no damage and no foreign matter being stuck to the gasket.
  - Be sure to tighten the screw with the specified torque.
- If the SI unit is not assembled properly, inside PCBs may be damaged or liquid and/or dust may enter into the unit.

## Setting

### Switch setting

The switches should only be set with the power supply turned off. Open the cover and set the rotary switches and DIP switch with a small flat blade screwdriver.

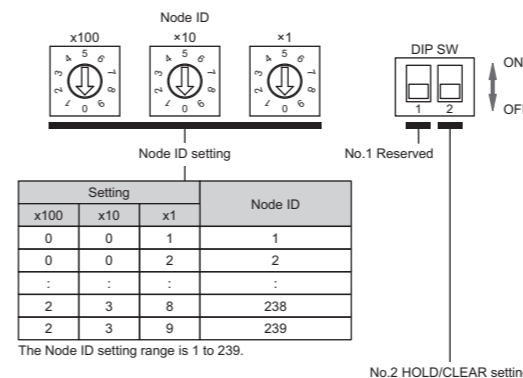

Setting			Node ID
x100	x10	x1	Node ID
0	0	1	1
0	0	2	2
:	:	:	:
2	3	8	238
2	3	9	239

The Node ID setting range is 1 to 239.

HOLD/CLEAR	No.2	Description
HOLD	ON	Hold the last state before communication error.
CLEAR	OFF	Clear all outputs.

### Configuration

In order to configure the SI unit for the POWERLINK network, the appropriate device master file (XDD file) for the SI unit will be required.

Technical documentation giving detailed configuration information and the XDD file can be found on the SMC website (URL <http://www.smcworld.com>).

### XDD file

	Model number	XDD file
1	EX260-SPL1	FFFF0007_EX260-SPL1.xdd
2	EX260-SPL3	FFFF0007_EX260-SPL3.xdd

## Troubleshooting

Technical documentation giving detailed troubleshooting information can be found on the SMC website (URL <http://www.smcworld.com>).

## Specifications

Connected load: 24 VDC Solenoid valve with surge voltage suppressor of 1.5 W or less (manufactured by SMC)  
Current consumption of power supply for SI unit operation: 0.1 A max.  
Ambient temperature for operation: -10 to 50 °C  
Ambient temperature for storage: -20 to 60 °C

Technical documentation giving detailed specification information can be found on the SMC website (URL <http://www.smcworld.com>).

## Outline Dimensions

Technical documentation giving detailed outline dimensions information can be found on the SMC website (URL <http://www.smcworld.com>).

## Accessories

Technical documentation giving detailed accessories information can be found on the SMC website (URL <http://www.smcworld.com>).

SMC Corporation URL <http://www.smcworld.com>

Akihabara UDX 15F, 4-14-1, Sotokanda, Chiyoda-ku, Tokyo 101-0021, JAPAN  
Phone: +81 3-5207-8249 Fax: +81 3-5298-5362

Note: Specifications are subject to change without prior notice and any obligation on the part of the manufacturer.  
© 2018 SMC Corporation All Rights Reserved EX※:OMV0018