



Operation Manual

Installation · Operation

Original Instructions

Thermo chiller

**Air-Cooled
refrigerated type**
HRS040-A*-20-*

**Water-Cooled
refrigerated type**
HRS040-W*-20-*

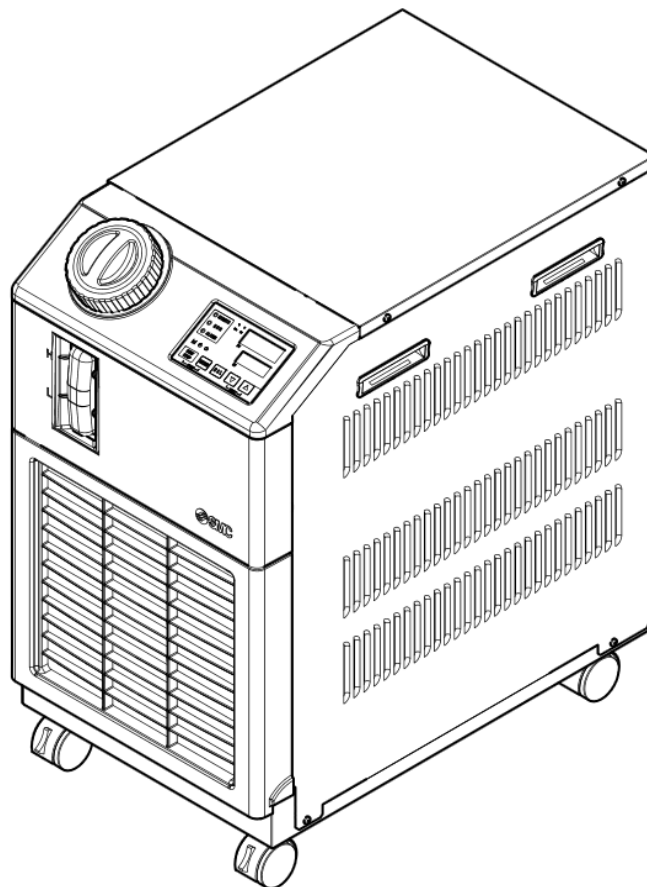

Keep this manual available whenever necessary

To the users

Thank you for purchasing SMC's Thermo chiller (hereinafter referred to as the "product").

For safety and long life of the product, be sure to read this operation manual (hereinafter referred to as the "manual") and clearly understand the contents.

- Be sure to read and follow all instructions noted with "Warning" or "Caution" in this manual.
- This manual is intended to explain the installation and operation of the product. Only people who understand the basic operation of the product through this manual or who perform installation and operation of or have basic knowledge about industrial machines are allowed to work on the product.
- This manual and other documents attached to the product do not constitute a contract, and will not affect any existing agreements or commitments.
- It is strictly prohibited to copy this manual entirely or partially for the use by a third party without prior permission from SMC.

Note: This manual is subject to possible change without prior notice.

Contents

Chapter 1	Safety Instructions	1-1
1.1	Before using the product	1-1
1.2	Reading the Manual	1-1
1.3	Hazards	1-2
1.3.1	Level of hazards	1-2
1.3.2	Definition of "Serious injury" and "Minor injury"	1-2
1.3.3	Types of hazard labels	1-3
1.3.4	Locations of Hazard Labels	1-4
1.4	Other Labels	1-5
1.4.1	Product Label	1-5
1.5	Safety Measures	1-5
1.5.1	Safety Instructions for Use	1-5
1.5.2	Personal Protective Equipment	1-6
1.6	Emergency Measures	1-7
1.7	Waste disposal	1-8
1.7.1	Disposal of refrigerant and compressor oil	1-8
1.7.2	Disposal of product	1-8
1.8	Material Safety Data Sheet (MSDS)	1-8
Chapter 2	Name and Function of Parts	2-1
2.1	Part number of product	2-1
2.2	Name and Function of Parts	2-2
2.3	Function of Parts	2-3
2.4	Operation display panel	2-4
Chapter 3	Transport and Setting Up	3-1
3.1	Transport	3-1
3.1.1	Transportation using casters	3-2
3.2	Installation	3-3
3.2.1	Environment	3-4
3.2.2	Location (Required ventilation rate and facility water source)	3-6
3.2.3	Installation and Maintenance Space	3-7
3.3	Installation	3-8
3.3.1	Mounting	3-8
3.3.2	Electrical wiring	3-9
3.3.3	Preparation and wiring of power supply cable	3-10
3.3.4	Wiring of remote operation signal input	3-12
3.3.5	Wiring of operation signal output and alarm signal output	3-14
3.3.6	RS-485 Communication wiring	3-15

3.3.7	RS-232C Communication wiring	3-16
3.4	Piping.....	3-17
3.5	Fill of circulating fluid.....	3-19
3.6	Option J Piping of [Automatic fluid filling]	3-20
3.7	Wiring of external switch.....	3-21
3.7.1	Reading of the External switch	3-22
3.7.2	Wiring.....	3-23
3.7.3	Setting items	3-24
Chapter 4	Starting the Product.....	4-1
4.1	Before Starting.....	4-1
4.2	Preparation for Start	4-2
4.2.1	Power supply	4-2
4.2.2	Setting of circulating fluid temperature	4-2
4.3	Preparation of circulating fluid	4-3
4.4	Starting and Stopping.....	4-6
4.4.1	Starting the product	4-6
4.4.2	Stopping the product.....	4-7
4.5	Check items after starting	4-8
4.6	Adjustment of Circulating Fluid.....	4-8
Chapter 5	Display and setting of various functions	5-1
5.1	List of function.....	5-1
5.2	Function.....	5-2
5.2.1	Key operations.....	5-2
5.2.2	List of parameters.....	5-4
5.3	Main screen.....	5-6
5.3.1	Main screen	5-7
5.3.2	Display on the main screen	5-7
5.4	Alarm display menu.....	5-8
5.4.1	Alarm display menu	5-8
5.4.2	Content of display of alarm display menu.....	5-8
5.5	Inspection monitor menu	5-9
5.5.1	Inspection monitor menu	5-9
5.5.2	Checking of the Inspection monitor menu	5-9
5.6	Key-lock.....	5-13
5.6.1	Key-lock.....	5-13
5.6.2	Key-lock setting / checking	5-14
5.7	Run timer, stop timer function	5-15
5.7.1	Run timer and stop timer function.....	5-15

5.7.2	Setting and checking of Run timer and stop timer function.....	5-17
5.8	Signal for completion of preparation (TEMP READY).....	5-19
5.8.1	Signal for completion of preparation (TEMP READY)	5-19
5.8.2	Signal for completion of preparation (TEMP READY) setting / checking	5-20
5.9	Offset function.....	5-22
5.9.1	Offset function	5-22
5.9.2	Offset function setting and checking	5-24
5.10	Function to recover from power failure	5-26
5.10.1	Function to recover from power failure.....	5-26
5.10.2	Function to recover from power failure setting and checking.....	5-27
5.11	Anti-freezing function	5-28
5.11.1	Anti-freezing function.....	5-28
5.11.2	Anti-freezing function setting and checking.....	5-29
5.12	Key click sound setting	5-30
5.12.1	Key click sound setting.....	5-30
5.12.2	Key click sound setting and checking	5-30
5.13	Temperature unit switching.....	5-31
5.13.1	Temperature unit switching.....	5-31
5.13.2	Temperature unit switching setting and checking.....	5-31
5.14	Pressure unit switching	5-32
5.14.1	Pressure unit switching	5-32
5.14.2	Pressure unit switching setting and checking	5-32
5.15	Alarm buzzer sound setting.....	5-33
5.15.1	Alarm buzzer sound setting.....	5-33
5.15.2	Alarm buzzer sound setting and checking.....	5-33
5.16	Alarm customize function.....	5-34
5.16.1	Alarm customize function	5-34
5.16.2	Alarm customize function setting and checking	5-36
5.16.3	Setting of temperature alarm monitoring method and alarm generation timing.....	5-48
5.17	Data reset function.....	5-50
5.17.1	Data reset function	5-50
5.17.2	Method of resetting data reset function.....	5-50
5.18	Accumulated time reset function	5-51
5.18.1	Accumulated time reset function	5-51
5.18.2	Method of resetting accumulated time reset function	5-51
5.19	Communication function	5-53
5.19.1	Communication function.....	5-53

5.19.2	Communication function setting and checking	5-53
Chapter 6	Option·Optional Accessories.....	6-1
6.1	Option J [Automatic fluid filling].....	6-1
6.1.1	Option J [Automatic fluid filling]	6-1
6.2	Option M [DI water (Pure water) piping]	6-2
6.2.1	Option M [DI water (Pure water) piping]	6-2
6.3	Option T [High-pressure pump]	6-2
6.3.1	Option T [High-pressure pump]	6-2
6.4	Optional Accessories [Electric resistivity /conductivity sensor set].....	6-3
6.4.1	Optional Accessories [Electric resistivity/conductivity sensor set].....	6-3
6.5	Optional Accessories [Drain pan set].....	6-4
6.5.1	Optional Accessories [Drain pan set].....	6-4
6.5.2	Optional Accessories [Drain pan set] setting and checking.....	6-5
Chapter 7	Alarm indication and trouble shooting.....	7-1
7.1	Alarm Display	7-1
7.2	Alarm buzzer stop.....	7-3
7.3	Troubleshooting.....	7-4
7.4	Other Errors	7-6
Chapter 8	Control, Inspection and Cleaning	8-1
8.1	Control of Circulating Fluid Quality.....	8-1
8.2	Inspection and Cleaning.....	8-2
8.2.1	Daily check	8-2
8.2.2	Monthly check.....	8-3
8.2.3	Inspection every 3 months.....	8-4
8.2.4	Inspection every 6 months.....	8-5
8.2.5	Inspection for winter season	8-6
8.3	Consumables	8-6
8.4	Stop for a Long Time	8-7
8.4.1	Discharge of the circulating fluid and facility water.....	8-7
Chapter 9	Documents	9-1
9.1	Specifications List	9-1
9.1.1	Product specification.....	9-1
9.1.2	Refrigerant with GWP reference.....	9-2
9.1.3	Communication specifications	9-3
9.2	Outline dimensions.....	9-4
9.3	Flow Chart	9-5
9.3.1	HRS040-A*-20-(BJMTW)	9-5
9.3.2	HRS040-W*-20-(BJMTW)	9-6

9.4	Cooling capacity	9-7
9.4.1	HRS040-**-20-(BJMTW)	9-7
9.5	Heating capacity	9-7
9.5.1	HRS040-A-20-(BJMTW).....	9-7
9.5.2	HRS040-W-20-(BJMTW).....	9-7
9.6	Pump capacity	9-8
9.6.1	HRS040-**-20-(BJMW).....	9-8
9.6.2	HRS040-**-20-T	9-8
9.7	Required facility water flow (For water-cooled type)	9-9
9.8	Compliance	9-9
9.9	Sample DoC	9-10
9.10	Daily Check Sheet	9-11
Chapter 10	Product Warranty	10-1

Chapter 1 Safety Instructions



Before using the product be sure to read and understand all the important actions highlighted in this manual.

1.1 Before using the product

- This chapter is intended to specifically describe the safety related issues for handling the product. Read this before handling the product.
- The product is a cooling device using circulating fluid. SMC does not take any responsibility for any problems that may arise from using the product for other purposes.
- This product is for indoor use only and not to be used outdoors.
- This product is not designed for a clean room. It generates dust from the internal components such as pump and fan motor.
- The product is operated at high voltage and contains components which become hot and rotate. If a component needs to be replaced or repaired, contact a specialized vendor for parts and service.
- All personnel who work with or around the product should read and understand the safety related information in this manual carefully before starting work.
- The safety manager is responsible for strictly observing safety standards, but responsibility in respect to safety standards during daily work resides with each individual operator and maintenance personnel.
- This manual must be kept available to operators whenever necessary.

1.2 Reading the Manual

This manual contains symbols to help identify important actions when installing, operating or maintaining the product.



This sign indicates actions that must be followed.



This sign indicates prohibited actions.

1.3 Hazards

1.3.1 Level of hazards

The instructions given in this manual aim to assure the safe and correct operation of the product, and to prevent injury of operators or damage to the product. These instructions are grouped into three categories, Danger, Warning and Caution, which indicate the level of hazard, damage and also the degree of emergency. All safety critical information should be carefully observed at all times.

“DANGER”, “WARNING” and “CAUTION” signs are in order according to severity (DANGER> WARNING> CAUTION).

DANGER

“DANGER”: Hazard that **WILL** cause serious personal injury or death during operation.

WARNING

“WARNING”: Hazard that **MAY** cause serious personal injury or death during operation.

CAUTION

“CAUTION”: Hazard that **MAY** cause minor personal injury.

CAUTION

“CAUTION without exclamation symbol”: Hazard that **MAY** cause damage or failure of the product, facility, devices, ect.

1.3.2 Definition of “Serious injury” and “Minor injury”

■ “Serious injury”

This term describes injuries that result in after effects including loss of eyesight, burns, electrical shock, fracture, poisoning, etc. and requires long-term treatment or hospitalization.

■ “Minor injury”

This term describes injuries that do not need long-term treatment or hospitalization. (Others excluded from serious injury.)

1.3.3 Types of hazard labels

The product has various potential hazards and they are marked with warning labels. Be sure to read this section before starting any work on the product.

■ Warning related to electricity

⚠ WARNING	
	<p>This symbol stands for a possible risk of electric shock.</p> <p>The product is operated at high voltage and contains uncovered live terminals inside.</p> <ul style="list-style-type: none"> ● DO NOT operate the product without cover panels fitted. ● DO NOT work inside this product unless you have been trained to do so.

■ Warning related to high temperatures

⚠ WARNING	
	<p>This symbol stands for a possible risk of hot surface and burns.</p> <p>The product has surfaces that can reach high temperatures during operation. Even after the power is turned off, there can still be residual heat in the product.</p> <ul style="list-style-type: none"> ● DO NOT operate the product without cover panels fitted. ● DO NOT start working inside the product until the temperature has decreased sufficiently.

■ Warning related to rotating objects

⚠ WARNING	
	<p>This symbol stands for a possible risk of cutting fingers or hand, or entanglement by rotating fan (For air-cooled type).</p> <p>The product contains a cooling fan that rotates during operation of the product.</p> <p>The fan can start and stop intermittently and without warning.</p> <ul style="list-style-type: none"> ● DO NOT operate the product without cover panels fitted.

■ Warning related to other general dangers

⚠ WARNING	
	<p>This symbol stands for general danger.</p> <p>Hazards Inside</p> <p>Hot Surfaces Inside – See Hot Surface symbol</p> <p>Rotating Fan Inside – See Rotating Fan symbol (For air-cooled type)</p> <p>Pressurized Sytem Inside – The product contains pressurised fluid systems.</p> <ul style="list-style-type: none"> ● DO NOT operate the product without cover panels fitted.

1.3.4 Locations of Hazard Labels

There are various warning labels on the product to show the potential hazards.

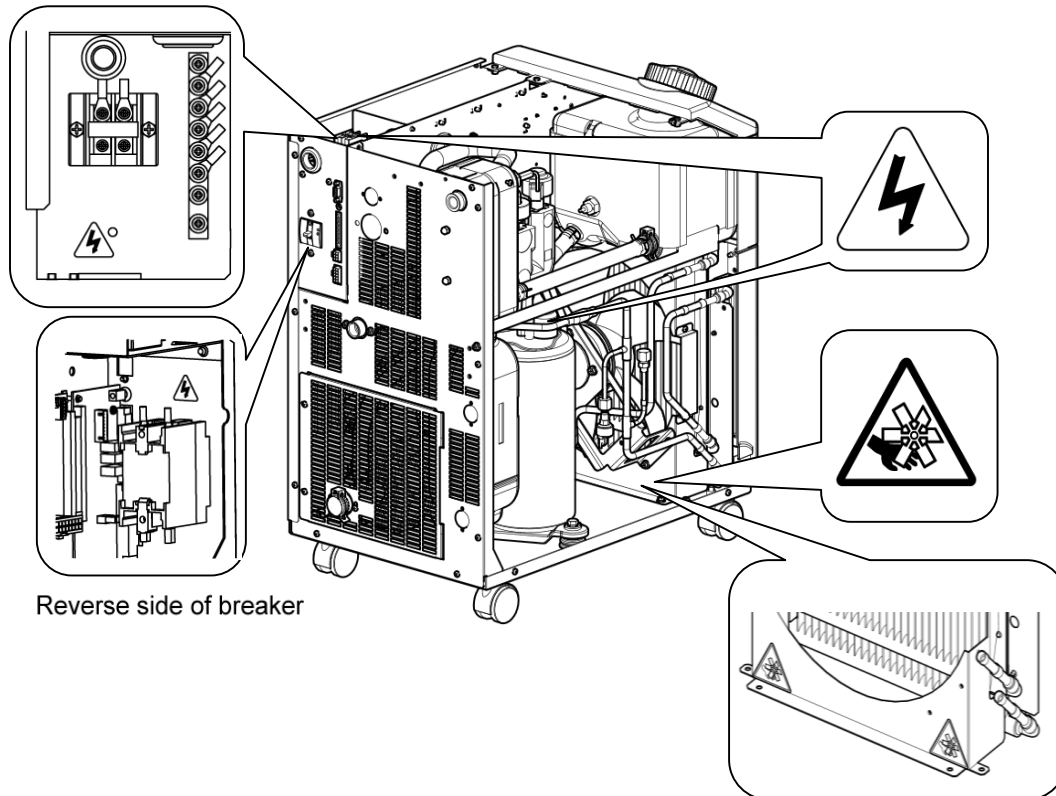

Reverse side of breaker

Fig. 1-1 Warning label position

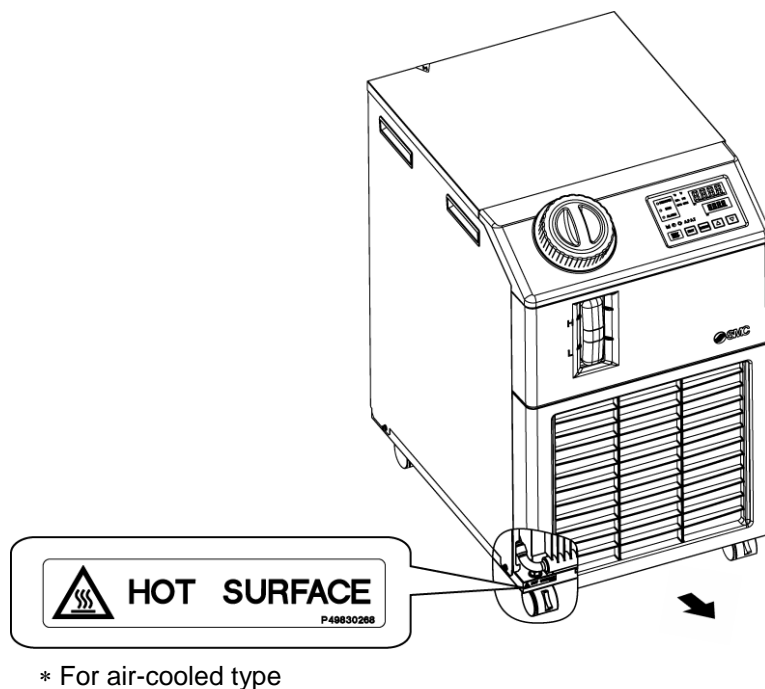
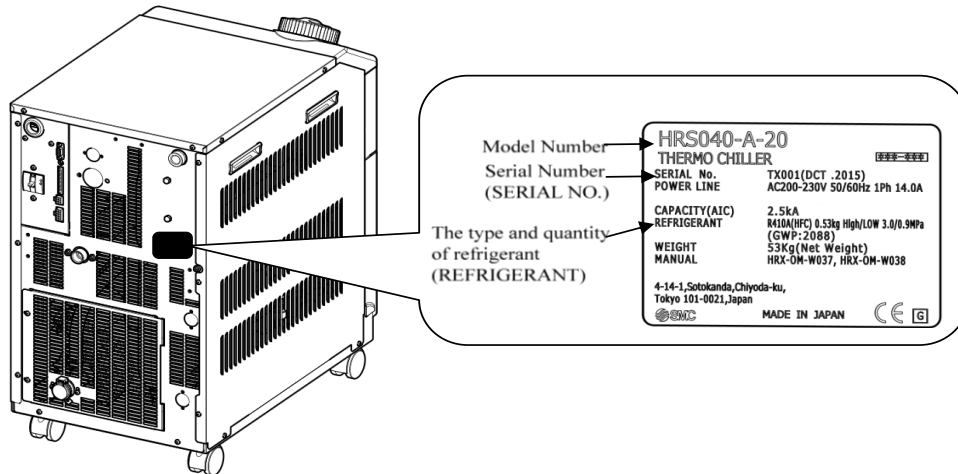

Fig. 1-2 Warning label position

1.4 Other Labels

1.4.1 Product Label

Information about the product, such as Serial No. and Model No. can be found on the model label. This information is needed when contacting an SMC sales distributor.



* (It is an example of model "HRS040-A-20".)
How to see the manufacturing code **P O 001** (January 2011)

O			O			001
Year	Symbol	Remarks	Month	Symbol	Remarks	Serial no.
2011	P	Repeated from A to Z in alphabetical order	1	O	Repeated from O to Z in alphabetical order, with O for January and Z for December	—
2012	Q		2	P		
2013	R		3	Q		
↓	↓		↓	↓		

Fig. 1-3 Position of product label

1.5 Safety Measures

1.5.1 Safety Instructions for Use

⚠ WARNING



Follow the instructions below when using the product. Failure to follow the instructions may cause an accident and injury.

- Read and understand this manual carefully before using the product.
- Before starting maintenance of the product, be sure to lock out and tag out the breaker of the user's power supply.
- If operating the product during maintenance, be sure to inform all workers nearby.
- Use only the correct tools and procedure when installing or maintaining the product.
- Use personal protective equipment where specified ("1.5.2 Personal Protective Equipment")
- Check all parts and screws are fitted correctly and securely after maintenance.
- Avoid working in a drunken or sick condition, which might cause an accident.
- Do not remove the panels except for the cases permitted in this manual.
- Do not remove the panels during operation.

1.5.2 Personal Protective Equipment

This manual specifies personal protective equipment for each work.

■ Transport, Installing and Uninstalling

CAUTION



Always use safety shoes, gloves and head protection when transporting, installing or uninstalling the product.

■ Handling of circulating fluid

CAUTION



Always use safety shoes, gloves, mask, apron and eye protection when handling the circulating fluid.

■ Operation

CAUTION



Always use safety shoes and gloves when operating the product.

1.6 Emergency Measures

When emergency conditions such as natural disaster, fire and earthquake, or injury occurs, turn off the power supply switch. The switch is located at the front of the product.

⚠ WARNING



Even when the power supply switch is turned off, some of the internal circuits are still energized, unless the user's power supply is shut off. Be sure to shut off the breaker of the user's power supply.

1. Turn off the power supply switch at the back of the product to stop the operation of the thermo-chiller.

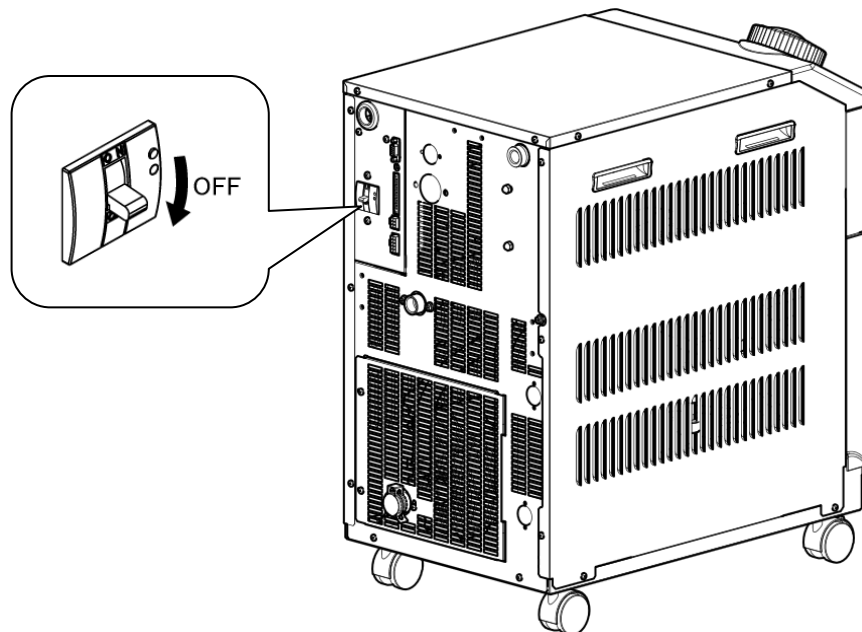

Fig. 1-4 Location of the switch for the power supply

2. Be sure to shut off the breaker of the facility power supply (the power supply of the user's machine).

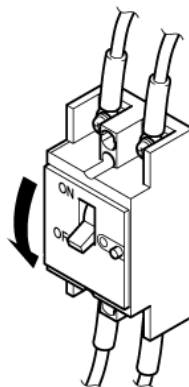

Fig. 1-5 Shut off of facility power supply

1.7 Waste disposal

1.7.1 Disposal of refrigerant and compressor oil

The product uses hydrofluorocarbon type refrigerant (HFC) and compressor oil. Comply with the laws and regulations in each country for the disposal of refrigerant and compressor oil. The type and quantity of refrigerant is described on the 1.4.1 Product Label.

If these fluids need to be recovered, read and understand the instructions below carefully. If there is any unclear point, contact an SMC's sales distributor.

WARNING



- Only maintenance personnel or qualified people are allowed to open the cover panels of the product.
- Do not mix the compressor oil with domestic waste for disposal. Also, the disposal of the waste must only be conducted by specific facilities that are permitted for that purpose.

WARNING



- Comply with the laws and regulations in each country for the disposal of refrigerant and compressor oil.
- The release of refrigerant in to the atmosphere is banned by law. Recover it with specific equipment and dispose of it correctly.
- Only people who have sufficient knowledge and experience about the product and its accessories are allowed to recover the refrigerant and compressor oil.

1.7.2 Disposal of product

The disposal of the product must be handled by a specialized industrial waste disposal agency in accordance with local laws and regulations.

1.8 Material Safety Data Sheet (MSDS)

If the material safety data sheets of chemicals used in this product are needed, contact an SMC's sales distributor.

Any chemicals used by the user must be accompanied by an MSDS.

Chapter 2 Name and Function of Parts

2.1 Part number of product

The product can be ordered with the part number configured as shown below.
 The product needs to be handled in different ways depending on the part number. Refer to "1.4.1 Product Label" and check the part number of the product.

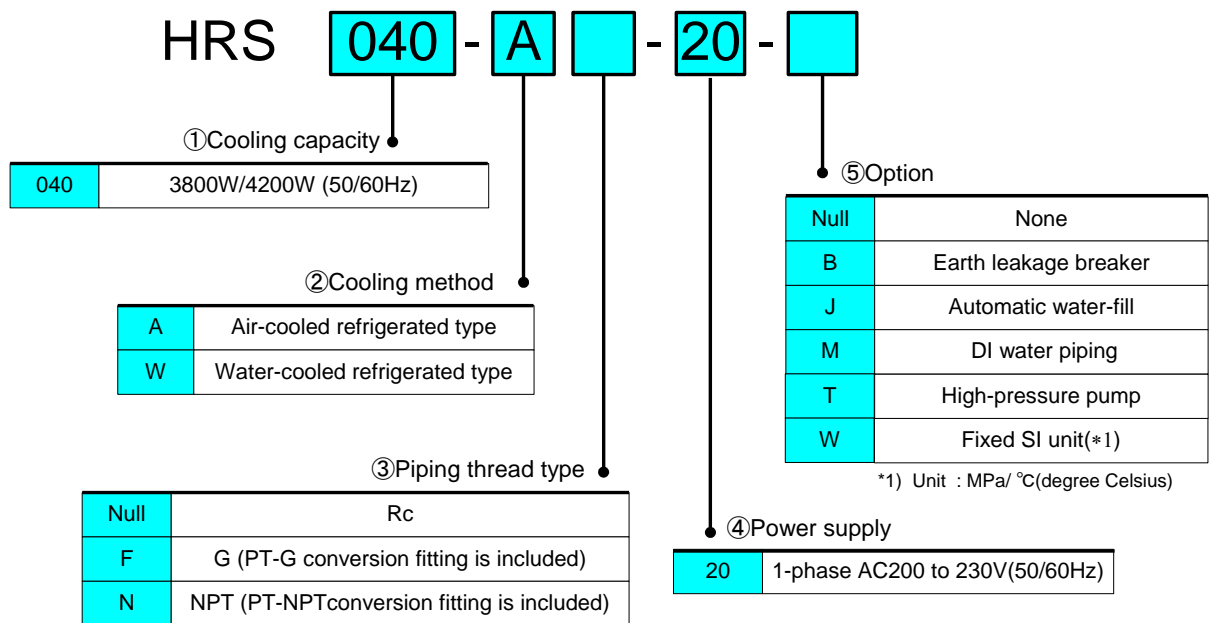

Fig. 2-1 Part number of product

2.2 Name and Function of Parts

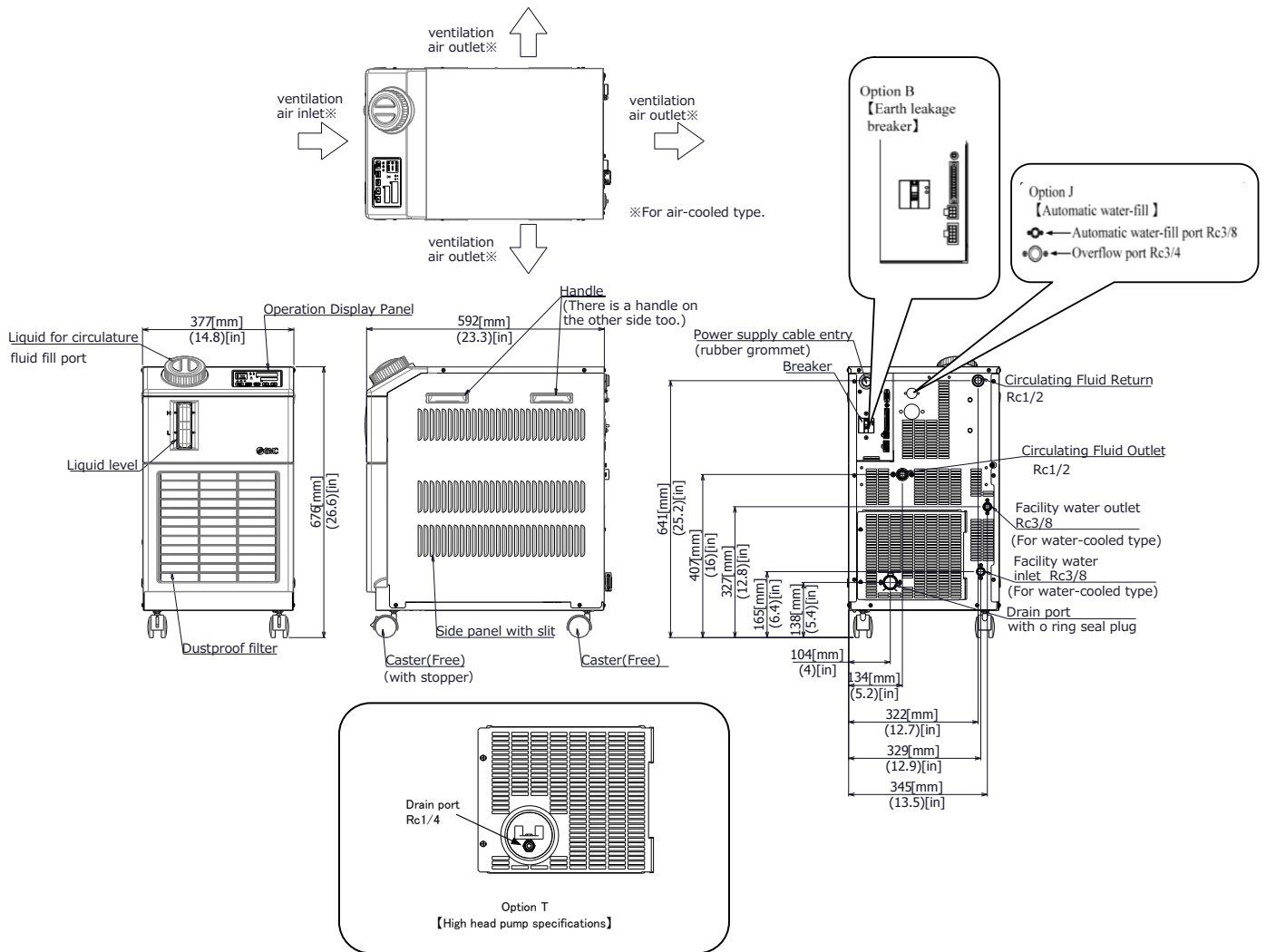







Fig. 2-2 Names of each part

Table 2-1 Accessories list

1	Alarm code list label		1pc.
2	Operation Manual		2pcs. (Jpn: 1pc. Eng: 1pc.)
3	Sequence I/O command signal connector		1pc.
4	Ferrite core (For communication)		1pc.
5	Cable tie (For power supply cable fixture)		1pc.
6	Fitting (for drain port)*		1pc.

* Not included when option T [High pressure pump] is selected.

2.3 Function of Parts

The function of parts is as follows.

Table 2-2 Function of parts

Name	Function
Operation display panel	Runs and stops the product and performs settings such as the circulating fluid temperature. For details, refer to "2.4 Operation display panel".
Fluid level gauge	Indicates the circulating fluid level of the tank. For details, refer to "3.5 Fill of circulating fluid".
Breaker	Shuts off the power supply to the internal equipment of product. Breaker size 20A (There are energized parts in the product)
Model label	Shows the part number of the product. For details, refer to "1.4.1 Product Label".
Circulating fluid outlet port	The circulating fluid flows out from the outlet port.
Circulating fluid return port	The circulating fluid returns to the return port.
Drain port	This drain port to drain the circulating fluid out of the tank.
Facility water inlet (For water-cooled type)	A facility water inlet to which the facility water is fed through piping. The pressure of facility water should be in a range of 0.3 to 0.5MPa.
Facility water outlet (For water-cooled type)	A facility water outlet from which the facility water returns to the user's machine through piping.
Automatic water-fill port (When automatic fluid filling [Option J] is selected.)	Piping to the automatic fluid filling port enables easy supply of the circulating fluid through the built-in solenoid valve. The supply pressure should be in a range of 0.2 to 0.5MPa.
Overflow port (When automatic fluid filling [Option J] is selected.)	This is necessary when automatic fluid filling function. Discharge excess circulating fluid when the fluid level in the tank rises.

2.4 Operation display panel

The operation panel on the front of the product controls the basic operation of the product.

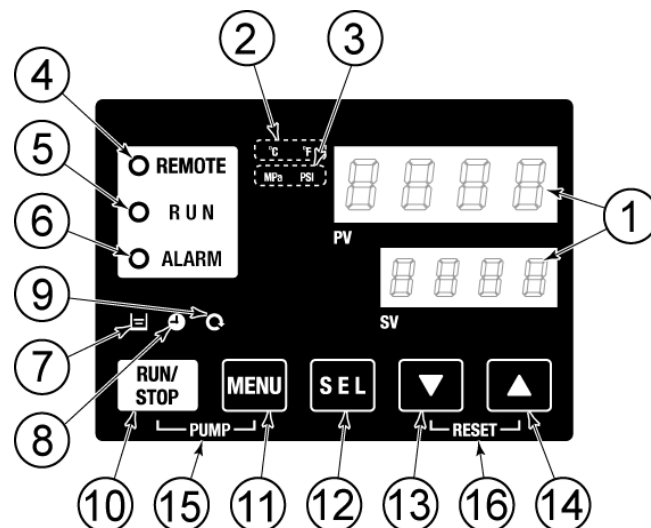



Fig. 2-3 Operation display panel

Table 2-3 Operation display panel

No	Description	Function		Reference page
①	Digital display (7 segment, 4 digits)	PV	Displays the temperature and pressure of the circulating fluid and alarm codes.	0
		SV	Displays the set temperature of the circulating fluid and the set values of other menus.	
②	[°C °F] lamp	Displays the unit of display temperature (°C or °F).		5.13
③	[MPa PSI] lamp	Displays the unit of display pressure (MPa or PSI).		5.14
④	[REMOTE] lamp	Lights up during remote operation by communication.		5.19
⑤	[RUN] lamp	<ul style="list-style-type: none"> • Lights up when the product is started and in operation. Goes off when the product is stopped. • Flashes during stand-by for stop (Interval 0.5 seconds). • Flashes during independent operation of the pump (Interval 0.3 seconds). • Flashes during anti-freezing function (At standby: Interval 2 seconds, At operation: Interval 0.3 seconds). 		4.4
⑥	[ALARM] lamp	Flashes with buzzer when alarm occurs (Interval 0.3 seconds).		5.4
⑦	[LOW] lamp	Lights up when the tank level indicator falls below the LOW level.		4.3
⑧	[TIMER] lamp	Lights up while the run timer or stop timer function is working.		5.7
⑨	[AUTO] lamp	Lights up when the product is in automatic operation.		5.10
⑩	[RUN/STOP] key	Makes the product start or stop.		4.4
⑪	[MENU] key	Shifts the main menu (display screen of temperature) the other menu (entry of set values and monitor screen).		5.2
⑫	[SEL] key	Changes the item in menu and enters the set value.		
⑬	[▼] key	Decreases the set value.		-
⑭	[▲] key	Increases the set value.		
⑮	[PUMP] key	When the [MENU] and [RUN/STOP] keys are held down simultaneously, the pump starts running independently.		4.3
⑯	[RESET] key	Keep the [▼] and [▲] keys pressed down simultaneously. This will stop the alarm buzzer and reset the [ALARM] lamp.		7.3

Chapter 3 Transport and Setting Up

⚠ WARNING	
	<ul style="list-style-type: none">● Only persons who have sufficient knowledge and experience about the product and system are allowed to transport and set up the product.● Especially pay attention to personal safety.

3.1 Transport

The product is heavy and has potential danger at transport. Also, to prevent damage and breakage of the product, be sure to follow these instructions for transport.

CAUTION	
	<p>Never lay the product on its side. The compressor oil will leak in to the refrigerant piping, which may cause early failure of the compressor.</p>

CAUTION	
	<ul style="list-style-type: none">● Drain the residual fluid from the piping as much as possible to prevent any spillage.

3.1.1 Transportation using casters

⚠ WARNING

 **This product is heavy.
Care should be taken when the product is transported on a slope.**

- 1.** Release the lock levers of the front casters.

- 2.** Push the handles on the right/left panel or the corner of the product to move the product to the destination.
Do not hold the product by the cap to move it. This will apply excess force to the piping of internal parts which may lead to malfunctions such as fluid leakage.

- 3.** To push the front or rear panel, push it by the corner. Pushing by the center of the panel may deform the shape. Care should be taken.

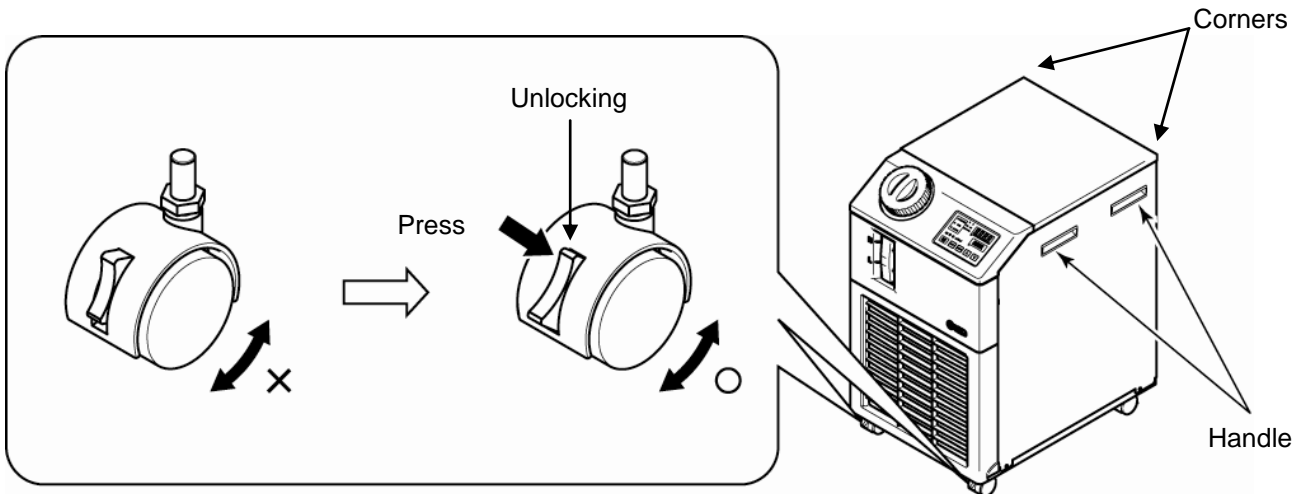

Fig. 3-1 Transportation using casters

3.2 Installation

WARNING



- Do not set up the product in places possibly exposed to leakage of flammable gas. Should any flammable gas stay around the product, the product may cause a fire.
- Do not use the product outdoors. If the product subjected to rain or water splash it may cause electrical shock, fire or failure.

CAUTION



- Keep the product horizontal to a rigid and flat floor which can resist the weight of the product, and take measures to prevent the product from tipping over. Improper installation may cause water leakage, tipping, damage of the product or injure the operator.
- Keep the ambient temperature of the product between 5 to 40°C. Operation below 5°C may cause the compressor failure, and operation above 40°C may cause the product to overheat and shut down.

3.2.1 Environment

The product must not be operated, installed, stored or transported in the following conditions. Potential malfunction or damage to the product may occur if these instructions are disregarded.

The product does not conform to any Clean room specifications. The pump and ventilating fan inside the product generate particles.

The installer/end user is responsible for carrying out an acoustic noise risk assessment on the equipment after installation and taking appropriate measures as required.

- Location that is outside.
- Location that is exposed to water, water vapour, steam, salt water or oil.
- Location that is exposed to dust or powder material.
- Location that is exposed to corrosive gas, organic solvent, chemical solution, or flammable gas (the product is not flame-proof)
- Location where the ambient temperature is out of the following range:
In transportation and In storage 0 to 50°C
(with no water or circulating fluid in piping)
In operation 5 to 40°C
- Location where the ambient humidity is out of the following range or where condensation occurs:
In transportation and storage 15 to 85%
In operation 30 to 70%
- Location that is exposed to direct sunlight or heat radiation.
- Location that is near heat sources and poor in ventilation.
- Location that is subjected to abrupt changes in temperature.
- Location that is subjected to strong electromagnetic noise (intense electric field, intense magnetic field, or surges).
- Location that is subjected to static electricity, or conditions where static electricity can discharge to the product.
- Location that is subjected to strong high frequencies radiation (microwaves).
- Location that is subjected to potential lightning strike.

- Location at altitude of 3000m or higher (except during product storage and transport).

*Because of lower air density, the heat radiation efficiencies of the devices in the product will be lower in the location at altitude of 1000m or higher. Therefore, the maximum ambient temperature to use and the cooling capacity will lower according to the descriptions in the table below. Please select the thermo chiller considering the descriptions.

1. Max. ambient temp.: Use the product in lower ambient temperature than the described value at each altitude.
2. Cooling capacity coefficient: The product's cooling capacity will lower to one that multiplied by the described value at each altitude.

Altitude [m]	1. Max. ambient temp. [°C]	2. Cooling capacity coefficient
Less than 1000m	40	1.00
Less than 1500m	38	0.85
Less than 2000m	36	0.80
Less than 2500m	34	0.75
Less than 3000m	32	0.70

- Bevelled place.
- Location where the product is affected by strong vibrations or impacts.
- Condition that applies external force or weight causing the product to be damaged.
- Location without adequate space for maintenance as required.

Others, Installation environment specifications

- Location where it is directly exposed to rain or snow.
- Place of Pollution Degree “1”or“2” (IEC60664-1).

3.2.2 Location (Required ventilation rate and facility water source)

CAUTION



- Do not install in a location which can be subjected to any of the conditions in 3.2.1 Environment.

CAUTION



The product radiates heat from the air vent of the cooling fan. If the product is operated with insufficient air ventilation the internal temperature can exceed 40°C*, which can cause an overload or affect the performance and life of the product. To prevent this ensure that suitable ventilation is available (see below).

■ **Installation of multiple products**

Keep sufficient space between products so that the air vented from one product will not be taken in by other products.

■ **Installation Area Ventilation (For air-cooled type)**

- ① Facility having a large installation area (that can vent the air naturally)
 Make an air vent on a wall at a high level and another air vent on a wall at a low level, to allow for adequate airflow.
- ② Facility having a small installation area (that can not vent the air naturally)
 Make a forced air exhaust vent on a wall at a high level and an air vent on a wall at a low level.

Table 3-1 Amount of radiation and required ventilation

Model	Heat Radiated kW	Required ventilation amount m ³ /min	
		Differential temp. of 3 °C between inside and outside of installation area	Differential temp. of 6 °C between inside and outside of installation area
HRS040-A*-20	Approx.8	120	70

CAUTION



The water-refrigerated thermo-cooler discharges heat by using facility water. Therefore, it is necessary to supply facility water from the source listed in the following table.

■ **Facility water source to be prepared (For water-cooled type)**

Table 3-2 Facility water source to be prepared

Model	Heat Radiated kW	Facility water temp. range °C	Required facility water rate l/min		
			Facility water temperature		
			25 °C	32 °C	40 °C
HRS040-W*□-20	Approx.8	5 to 40 (Rating 25)	15	18	26

3.2.3 Installation and Maintenance Space

It is recommended to keep the space around the product shown in Fig. 3-2. For maintenance, move the thermo-chiller into a space where maintenance work is possible.

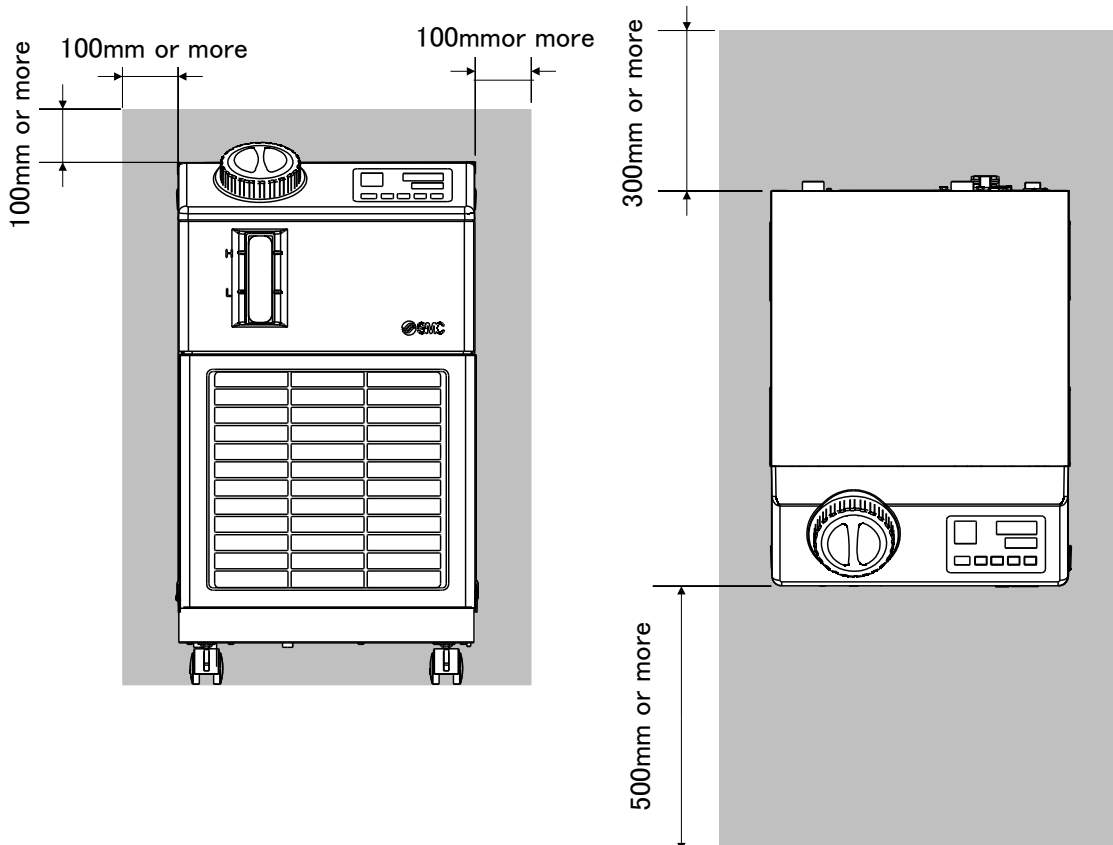

Fig. 3-2 Installation space

⚠ CAUTION

! The temperature of the outlet of for the ventilation of the thermo-chiller and the panel surface may become approx. 50°C or higher. When placing the thermo-chiller, ensure the thermo-chiller does not affect surrounding environment.

3.3 Installation

3.3.1 Mounting

- Mount the product on a flat and stable floor with no vibrations.
- Refer to "9.2 Outline dimensions" for dimensional information of the product.

■ How to mount the product

1. Move the product to the installation area.
-
2. After moving, lock the front casters again.

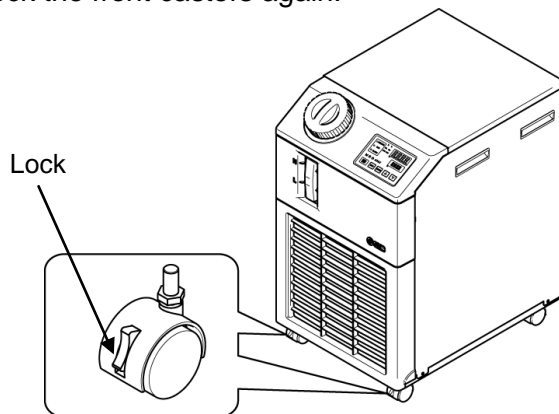

Fig. 3-3 Installation procedures

■ <Fixture>

Follow the procedure below when fixing the thermo-chiller to the floor or the mounting frame.

1. Prepare the fixing bracket shown below (Not included in the package).

Item	Part number
Anti-seismic brackets	HRS-TK002

2. Use M8 foundation bolts to fix the product within the dimensions below.

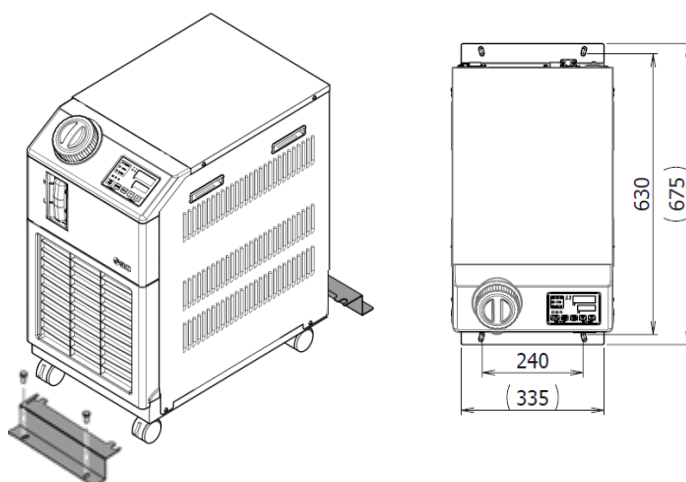



Fig. 3-4 Anti-seismic brackets installing

*4 (four) M8 foundation bolts should be prepared by the customer.

3.3.2 Electrical wiring

⚠ WARNING



- Do not modify the internal electrical wiring of the product. Incorrect wiring may cause electrical shock or fire. Also, modifying the internal wiring will void the product's warranty.
- Do not connect the ground to water line, gas pipe or lightning conductor.

⚠ WARNING



- Only qualified persons are allowed to wire the product.
- Be sure to shut off the user's power supply. Wiring with the product energized is strictly prohibited.
- The wiring must be conducted using cables complying with "Table 3-3" firmly and secured to the product to prevent the external force of cables being applied to the terminals. Incomplete wiring or improper securing of wiring may cause electrical shock, excessive heat and fire.
- Ensure a stable power supply with no voltage surges.
- Ensure that an Earth Leakage Breaker is used in the power supply of the product. See "Table 3-3".
- Use a power supply suitable for the specifications of the product. Choose Overvoltage category from class II (IEC60664-1)
- Be sure to connect the ground connection.
- Ensure that a lock out facility is available on the power supply.
- Each product must have its own separate Earth Leakage Breaker.

■ **Power supply cable and Earth Leakage Breaker**

Prepare the power supply shown in the following table. For the connection between the product and power supply, use the power supply cable and earth leakage breaker shown below.

Table 3-3 Power supply cable and Earth Leakage Breaker (Recommended)

Model	Power supply voltage		Cable qty. x size	Recommended earth leakage breaker		
				Rated voltage [V]	Rated current [A]	Sensitivity of leak current [mA]
HRS040-A*-20 HRS040-W*-20	1-phase 200-230V AC (50/60Hz)		3 cores x12AWG (3 cores x3.5mm ²) (including ground)	200, 230	20	30
	Terminal block screw diameter	Recommended crimp terminal				
	M4	5.5-4				

* For power supply cable, it is to be properly prepared by the customer in accordance with National Electrical Code and Canadian Electrical Code.

3.3.3 Preparation and wiring of power supply cable

⚠ WARNING



- The electrical facilities should be installed and wired in accordance with local laws and regulations of each country and by a person who has knowledge and experience.
- Check the power supply. Operation with voltages, capacities and frequencies other than the specified values can cause fire and electrical shock.
- Wire with an applicable cable size and terminal. Forcibly mounting with an unsuitable size cable may result in heat generation or fire.

⚠ WARNING



Be sure to lock out and tag out the breaker of the facility power supply (customer power supply facility) before wiring.

⚠ WARNING



Be sure to connect the power supply cable from the product side first, and then connect the breaker of the facility power supply (the user's machine power supply).

⚠ CAUTION



When the panel is removed or mouted, be sure to wear protective shoes and gloves to prevent injury with the edge of the panel.

■ Preparation

1. Remove six screws to remove the upper panel.

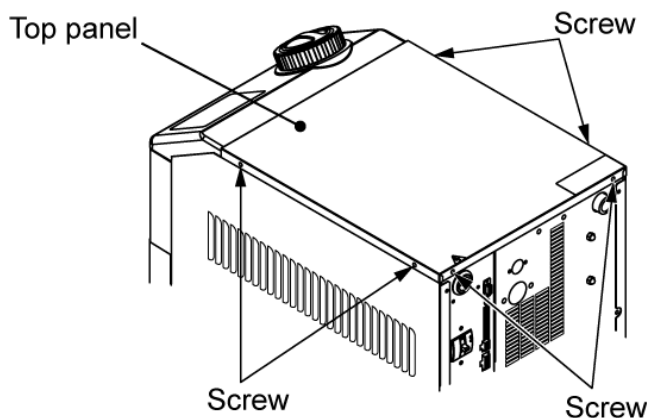

Fig. 3-5 Remove the upper panel

2. Pull the upper panel towards the back of the product, and lift it to remove.

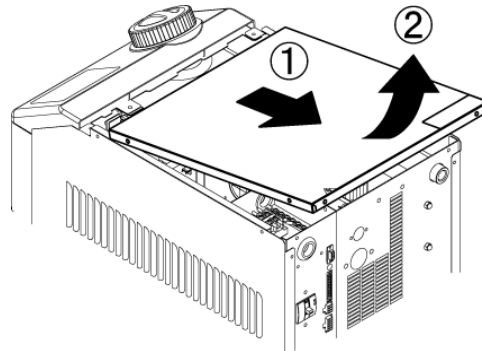

Fig. 3-6 Remove the upper panel

3. Connect the power supply cable and earth cable as shown in the figure below.

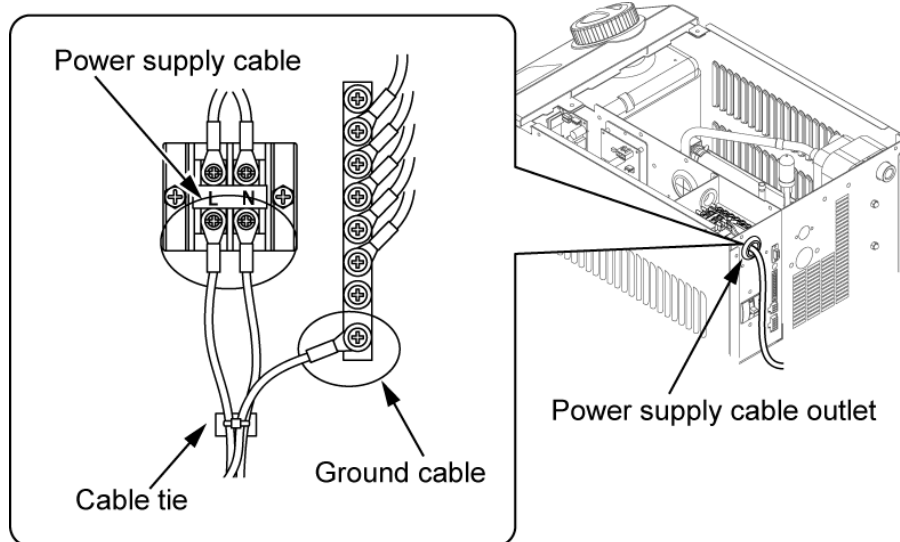

Fig. 3-7 Wiring of power supply cable and earth cable

* Connect over current protection to the power cable connected to the equipment in order to avoid hazard.

3.3.4 Wiring of remote operation signal input

The remote signal input is to enable the product to be run and stopped remotely by applying a contact signal input. This chapter illustrates examples of wiring

Select DIO mode as the communication mode to activate the remote control signal input. After wiring, select DIO mode referring to the Communications Operation manual.

[Tips]

This product has two input signals. These can be customized depending on the customer's application.

Refer to the Operation Manual for communication for details.

CAUTION

The capacity of the output contact of the product is limited. If the capacity is not large enough, install a relay, etc. (to allow for larger capacity). At the same time, ensure the input current of the relay is small enough in relation to the contact capacity of the product.

WARNING

 Be sure to shut off the breaker of the facility power supply (the user's machine power supply) before wiring.

1. For operation using remote signal, prepare the switch (source voltage: 24V, contact capacity: 35mA or more, min. load current: 5mA), and cable (dia. 0.14 to 1.5mm²).

2. Connect the remote control cable and the switch to the connector for the contact input/output, supplied as an accessory. Then, mount the ferrite core (3 turn) supplied as an accessory. (See below) (This is an example of wiring. Refer to the Operation Manual for communication for details.)

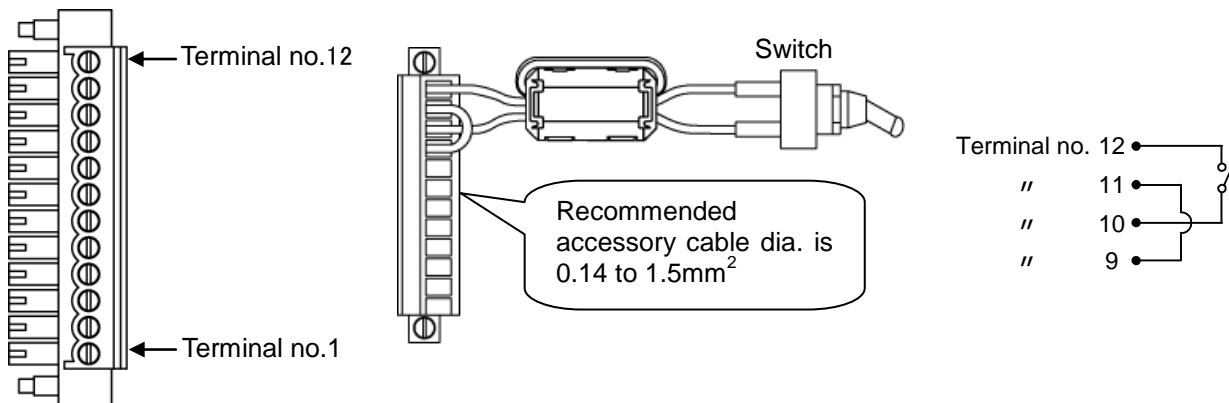

Fig. 3-8 Wiring of contact for remote signal inputs (Example)

3. Plug the prepared connector in to the contact input/output connector that is on the back of the thermo-chiller.

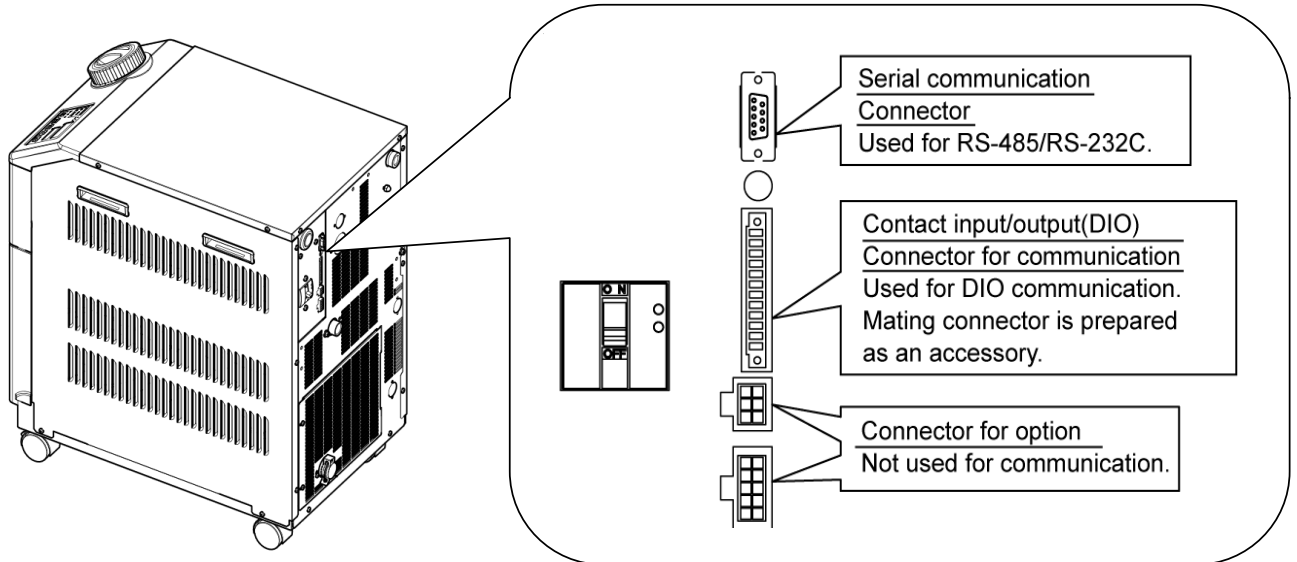

Fig. 3-9 Communication port

3.3.5 Wiring of operation signal output and alarm signal output

The operation signal output and alarm signal output are the outputs generated by a contact signal to shown the status of the product.

⚠ WARNING

Be sure to shut off the breaker of the facility power supply (the user's machine power supply) before wiring.

The specifications of the contact for each signal output are as follows.

Table 3-4 Signal output contact spec. at the time of shipment

Contact output	Signal explanation (Default setting)	Operation	
Output current 1 (Terminal no.5,6)	Run status signal	A	At run : Contact closed At stop : Contact open With power supply shut off : Contact open
Output current 2 (Terminal no.3,4)	Remote signal	A	At remote : Contact closed At non remote : Contact open With power supply shut off : Contact open
Output current 3 (Terminal no.1,2)	Alarm signal	B	At generation : Contact open Not generated : Contact closed With power supply shut off : Contact open

[Tips]

This product has three output signals which can be customized depending on the customer's application

Signals below can be output. Refer to the Communications Operation Manual for more details.

- Signal for completion of preparation (TEMP READY)
- Signal for operation stop alarm
- Signal for continuing operation alarm
- Signal for selection alarm
- Signal for operation start timer setting
- Signal for operation stop timer setting
- Signal for power recovery setting
- Signal for freezing prevention setting
- Contact input signal detection

3.3.6 RS-485 Communication wiring

Serial communication RS-485, operation start/stop, setting and reading of circulating fluid temperature, and reading of alarm condition can be done by remote control.

Refer to the Communications Operation Manual for more details.

■ Wiring of interface communication cable

⚠ WARNING

!

Be sure to shut off the breaker of the facility power supply (the user's machine power supply) before wiring.

- Connecting to PC

RS-485 cannot be directly connected to a normal PC. Use a RS-232C/RS485 converter which is available on the market.

Be sure to follow the wiring procedure below for connecting multiple thermo-chillers.

- Configuration of connection

One host computer : One thermo-chiller, or one host computer : N thermo-chillers.
(Max. 31 thermo-chillers can be connected.)

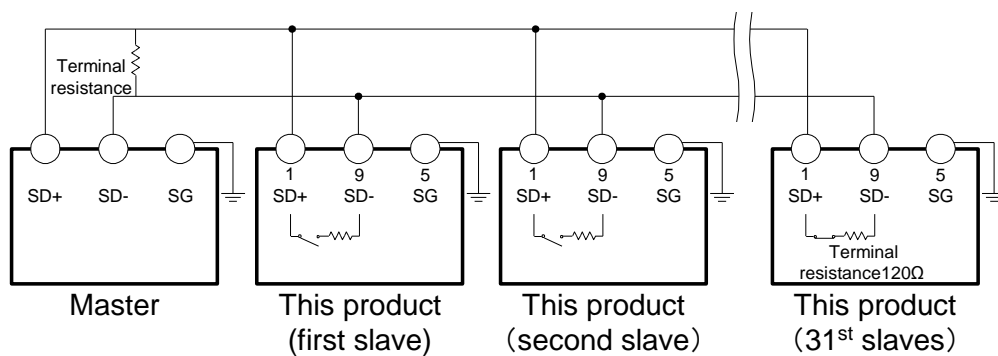

Fig. 3-10 Connection of RS-485

[Tips]

Both ends of the communication connection (the end nodes) need to be connected to the host computer.

The terminal resistance of this product can be set by the operation display panel. Refer to “5.19 Communication function”.

3.3.7 RS-232C Communication wiring

Serial communication RS-232C, operation start/stop, setting and reading of circulating fluid temperature, and reading of alarm condition can be done by remote control.

Refer to the Communications Operation Manual for more details.

■ Wiring of communication cable

⚠ WARNING



Be sure to shut off the breaker of the facility power supply (the user's machine power supply) before wiring.

Be sure to wire as shown in the figure below.

- Configuration
1 master : 1 thermo-chiller

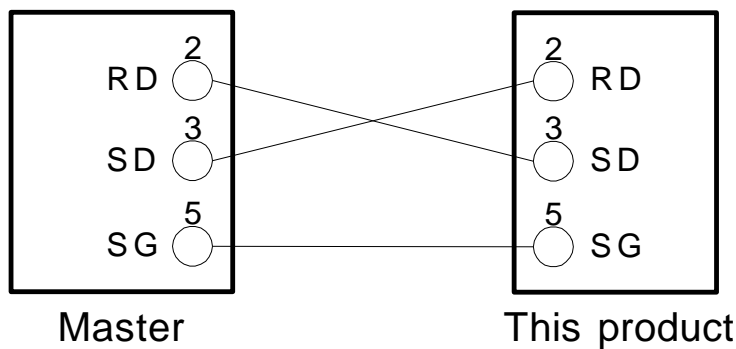



Fig. 3-11 Connection of RS-232C

3.4 Piping

CAUTION	
	<ul style="list-style-type: none"> ● Connect piping firmly. Incorrect piping might cause leakage of supplied or drained leakage and wet surrounding area and facility. ● Keep supply water pressure below 0.5MPa. ● Pay attention not to allow dust and foreign materials to enter into water circuit etc. during connection of piping. ● When the thermo-chiller is water-cooled refrigerated type, the temperature of the outlet of the facility water may become approx.60°C depending on operating conditions ● Hold the piping port firmly with specific wrench when tightening. ● The piping should be selected with due consideration of pressure and temperature. Otherwise, the piping can burst in service.

CAUTION	
	<ul style="list-style-type: none"> ● Check the model number of this product in "1.4.1 Product Label" of this manual before connecting piping. ● Model number: HRS040-*N-20 The transition connector from Rc to NPT is enclosed as an accessory. For NPT piping, be sure to use this connector. ● Model number: HRS040-*F-20 The transition connector from Rc to G is enclosed as an accessory. For G piping, be sure to use this connector.

■ Piping port size

Table 3-5 Piping port size

Name	Port size*1	Recommended tightening torque	Recommended proof pressure for piping
Circulating fluid supply	Rc1/2	28 to 30N·m	0.8MPa more
Circulating fluid return	Rc1/2	28 to 30N·m	0.8MPa more
Facility water inlet*3	Rc3/8	22 to 24N·m	1.0MPa more (Facility water pressure 0.3 to 0.5 MPa)
Facility water outlet*3	Rc3/8	22 to 24N·m	
Automatic water-fill port *2	Rc3/8	22 to 24N·m	1.0MPa more (Automatic water-fill pressure 0.2 to 0.5MPa)
Overflow port *2	Rc3/4	28 to 30N·m	Inside diameter 19mm more of piping

*1 For NPT and G thread, use a conversion connector available as an accessory separately.

*2 For Option J [Automatic fluid filling]

*3 For water-cooled type

■ How to connect piping

Tighten the piping to circulating fluid outlet / return port and facility water outlet / inl

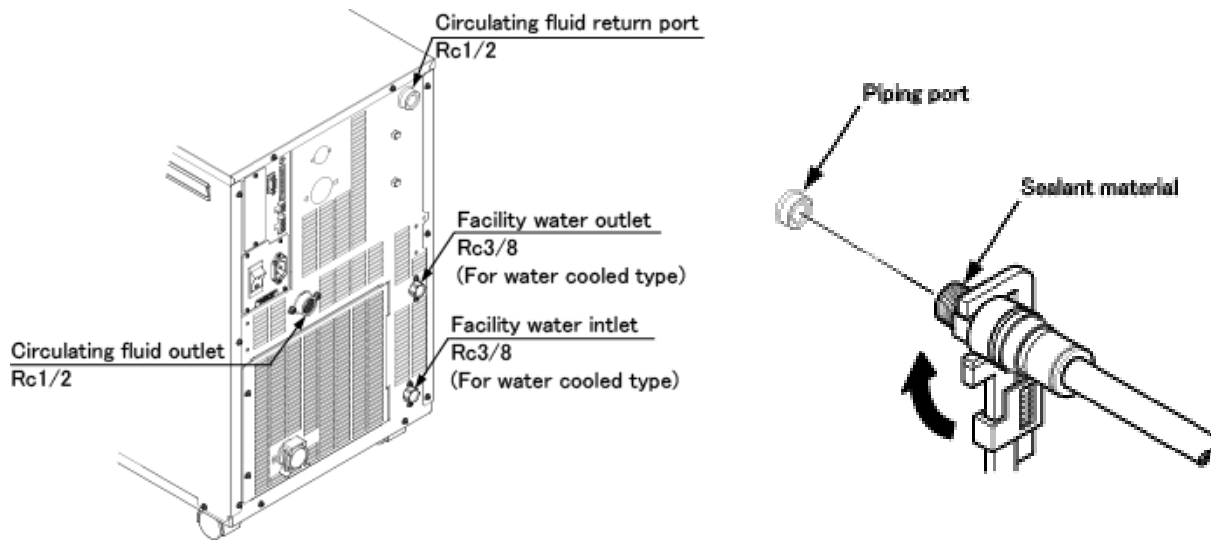

Fig. 3-12 Tightening of piping

■ Recommended piping circuit

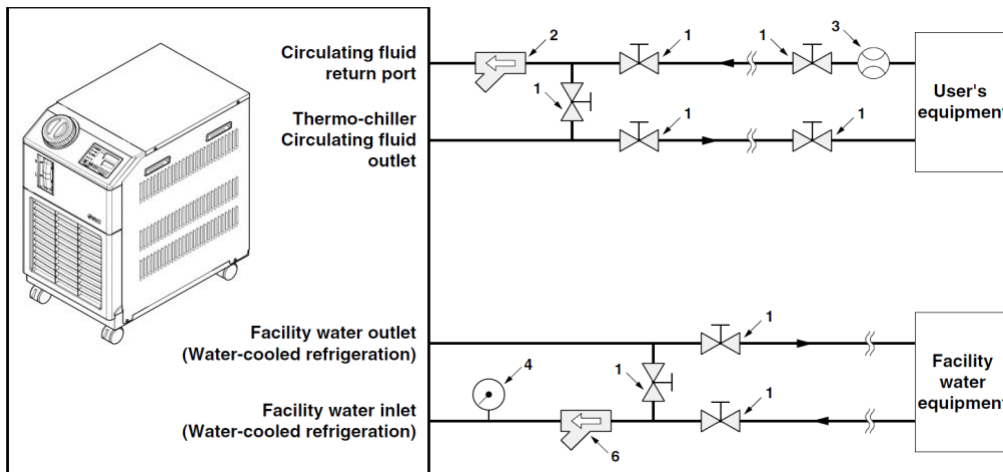

Fig. 3-13 Recommended piping circuit

No.	Description	Size	Recommended part no.	Note
1	Valve	Rc1/2	-	-
2	Y-strainer	Rc1/2 #500 to 1000	-	Install either the strainer or filter. If foreign objects with a size of 20 μm or more are likely to enter, install the particle filter.
	Filter	Rc1/2 20μm	HRS-PF001 or HRS-PF002	
3	Flow meter	0 to 50L/min	-	-
4	Pressure gauge	0 to 1.0MPa	-	-
5	Others (pipe, hose, etc.)	ø15 or more	-	-
6	Y-strainer	Rc1/2 #1000	-	Install either the strainer or filter. If foreign objects with a size of 20 μm or more are likely to enter, install the particle filter.
	Filter	Rc1/2 20μm	Note) FQ1011N-04-T020-B-X61	

Note) The filter shown above cannot be directly connected to the thermo-chiller. Install it in the user's piping system.

3.5 Fill of circulating fluid

Turn the tank lid anticlockwise to open. Supply the circulating fluid up to the “H” mark on the fluid level indicator. Use tap water which satisfies the water quality standard shown in Table 8-1, or a 15% aqueous solution of ethylene glycol.

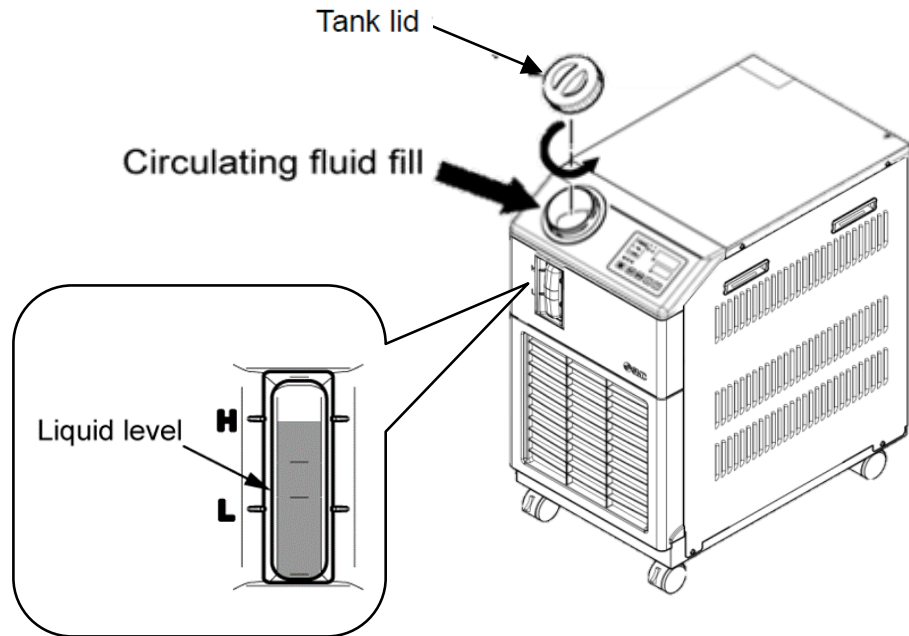

Fig. 3-14 Circulating fluid fill

CAUTION

- Check the drain port is closed by the valve to prevent the supplied circulating fluid from draining out.
- Supply the circulating fluid up to the “H” mark on the tank. Operation will stop when the fluid level falls lower than “L”.

CAUTION

- When the temperature of the circulating fluid is set to lower than 10°C, use a 15% aqueous solution of ethylene glycol. Tap water may freeze in the thermo-chiller, leading to malfunction.

■ **15% aqueous solution of ethylene glycol**

When a 15% aqueous solution of ethylene glycol is used, prepare the ethylene glycol aqueous solution separately.
To control the concentration of the ethylene glycol aqueous solution, a concentration meter is available separately from SMC.

Item	No	Remarks
Ethylene glycol aqueous solution 60%	HRZ-BR001	Please dilute to 15% with tap water and use it.
Densitometer	HRZ-BR002	—

3.6 Option J Piping of [Automatic fluid filling]

Automatic fluid filling port and over flow port need to be connected when optional [automatic fluid filling] is selected.

■ **Piping to automatic fluid filling port**

Connect the piping to supply the circulating fluid. Automatic fluid filling is performed by using the solenoid valve which is built in the thermo-chiller.

■ **Piping to the overflow port**

This is necessary when automatic fluid filling function is used. Discharge excess circulating fluid when the fluid level in the tank rises due to the failure of the solenoid valve etc.

Piping name	Port size	Piping specifications
Automatic water-fill inlet	Rc3/8	Supply pressure : 0.2 to 0.5MPa
Overflow outlet	Rc3/4	Piping should be within f19 of I.D. and 5m of length. Riser piping (trapping area) should be avoided.

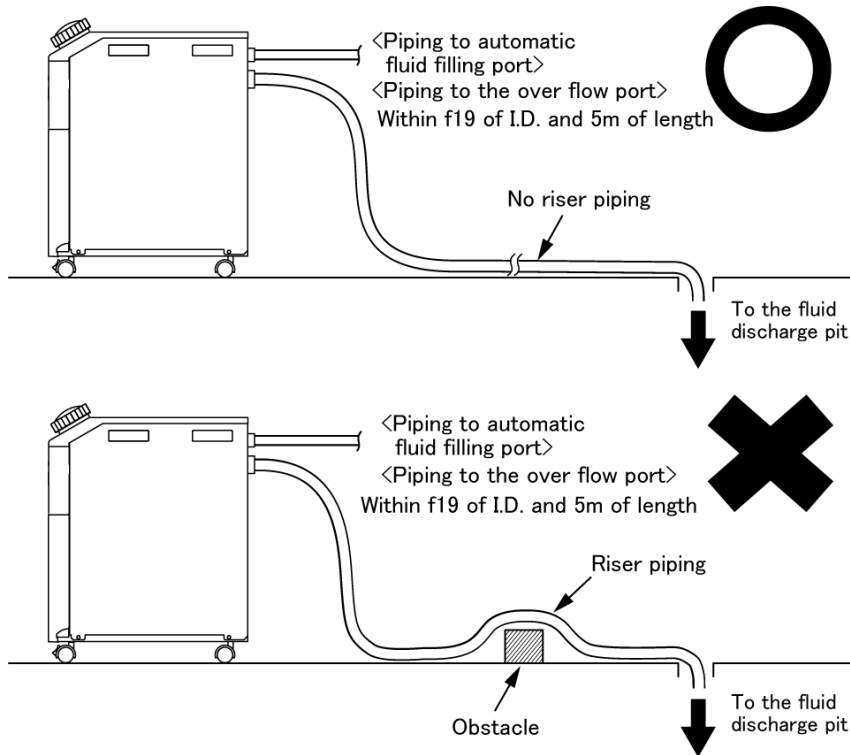

Fig. 3-15 Piping to automatic fluid filling port and overflow port

■ **Supplying fluid from the automatic fluid filling port**

Fluid filling starts if the power supply switch is turned ON when the fluid level of the circulating fluid is "L" of the level indicator or lower (P XX). Fluid supply stops when the fluid level reaches the proper level. If the fluid level does not reach the proper level within a fixed time after starting supplying fluid, it causes the alarm "AL01; Low level in tank". Fluid supply continues while the alarm is generated. Fluid supply stops after the fluid level reaching proper level. Alarm continues after fluid supply is completed. Release the alarm referring Chapter 6.

3.7 Wiring of external switch

This product can be monitored by sampling the signal of the external switch prepared by the customer.

Table 3-6 Power supply, contact specifications

Name	Terminal NO.	Specification
Power supply output	12(DC 24V)	DC 24V \pm 10% 0.5A MAX* ¹
	11(24V COM)	
Contact input signal 1	10(Contact input signal 1)	NPN open collector output PNP open collector output
	9(Common of contact output signal 1)	
Contact input signal 2	8(Contact input signal 2)	
	7(Common of contact output signal 2)	

*1 : To use the power of the device, the total load current must be 500mA or less.

If the load is 500mA or more, the internal fuse will be cut to protect the product and the alarm [AL21 DC line fuse cut] will be generated. Refer to Chapter 6 for handling of alarms.

One external switch can be connected to contact input signal 1 and one to contact input signal 2. (Two in total) The external switch cannot be connected to the contact input signal 1 depending on the communication mode. Table 3-7 shows the setting.

Table 3-7 Sets external switch

Communication mode *1		Contact input signal 1	Contact input signal 2
Local mode		○	○
SERIAL mode	MODBUS	○	○
	Simple communication protocol 1	○	○
	Simple communication protocol 2	×	○
DIO mode		×	○

*1 : Refer to the Communications Operation Manual for more details of each mode.

Local mode: Mode allowing the product to be operated by the operation panel. (Default setting)

SERIAL mode: Mode allowing the product to be operated by serial communication.

DIO mode: Mode allowing the product to be operated by the contact input/output communication.

3.7.1 Reading of the External switch

This product can be monitored during operation by reading the signal of the external switch prepared by the customer.

The product stops monitoring when it stops operation.

This product generates an alarm and stops operating when a problem is detected from the external switch.

You can set the product to continue operation or not to detect the alarm.

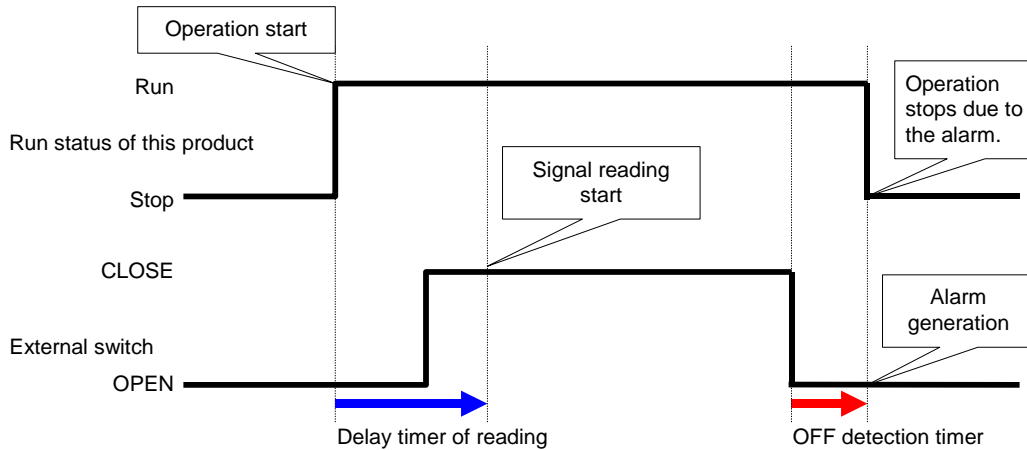

Fig 3-16 Timing chart of external switch monitoring

■ Delay timer of reading

If the signal of the external switch prepared by the customer is not closed instantly when the product is operated, set the delay timer for reading. By setting this timer, the external switch monitoring starts after the time set by the delay time of reading since the operation start.

“0” is the default setting. Set a time which is suitable for your environment.

Example} When using a flow switch

When operation is started, it takes time for the fluid to reach the piping and the flow switch to detect the flow. Set the time for the flow switch to start.

■ OFF detection timer

If you do not want the alarm to be generated instantly when the external switch prepared by the customer is in open status, but instead want the alarm to be generated after the switch has been open for a specific time (continuous open status), set the OFF detection timer.

This timer enables the alarm to be generated when the time set for OFF detection time passes after the switch is in OPEN status.

The default setting is 0 sec. Set a time which is suitable for your application.

■ Contact input

N.O type or N.C. type can be selected for the external switch. Set the signal which is suitable for the external switch prepared by the customer.

3.7.2 Wiring

As an example of connection of an external switch, the connecting method is shown below using the SMC flow switch (NPN, PNP).
This chapter illustrates examples of wiring

⚠ WARNING

Be sure to shut off the breaker of the facility power supply (the user's machine power supply) before wiring.

Table3-8 External switches used in examples

Name	Manufacturer	Part NO.	Out put type	Current consumption
Flow switch	SMC	PF2W7□□-□□-27□(-M)	NPN open collector output	70mA or less
		PF2W7□□-□□-67□(-M)	PNP open collector output	70mA or less

1. Prepare the external switch

2. Depending on the external switch output type, wire the switch to the connector for contact input / output (which is included as an accessory) as shown below. Mount the ferrite core (3 turns), which is included as an accessory. This is an example of wiring. Refer to the Communications Operation Manual for more details.

NPN open collector output

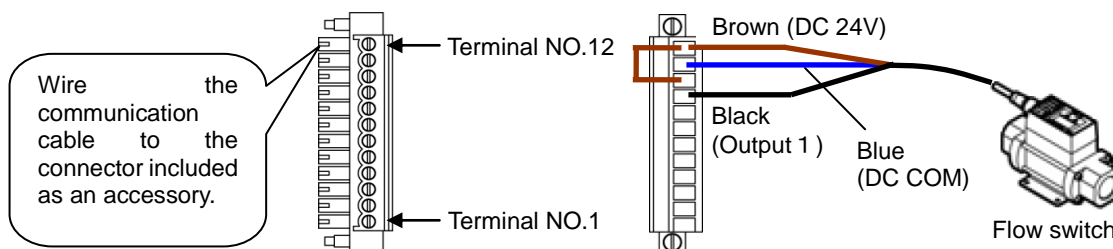

Fig 3-17 Wiring of the external switch (NPN open collector output) (example)

PNP open collector output

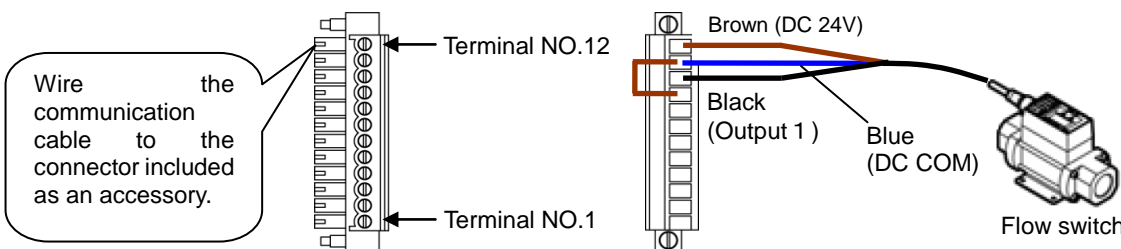

Fig 3-18 Wire the communication cable to the connector included as an accessory.

3. Plug the prepared connector in to the contact input/output connector that is on the back of the thermo-chiller.

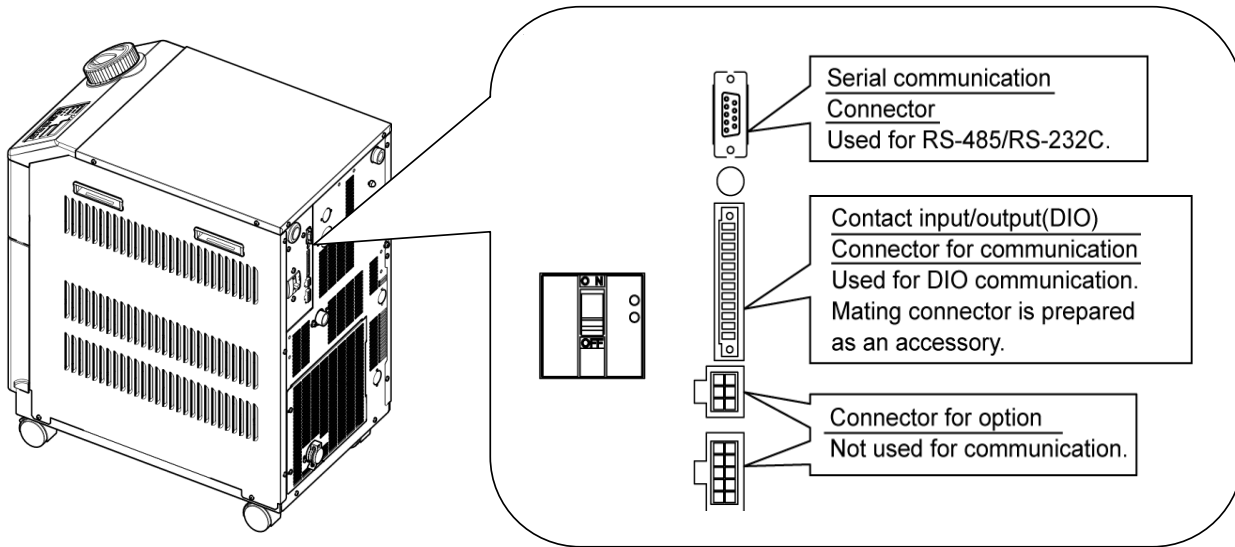

Fig 3-19 Connecting the connector

3.7.3 Setting items

Table 3-9 shows the setting items of the external switch. For details, refer to 5.19 Communication function.

Table 3-9 Setting list of the external switch

Display	Item	Initial value (Default setting)	Example*	Reference page	Category
[o.01]	Communication mode	LOC	LOC	5.19	Communication setting menu
[o.15]	Contact input signal 1	RUN	SW_A		
[o.16]	Contact input signal 1 type	ALT	ALT		
[o.17]	Contact input signal 1 delay timer (time delay) of reading	0	0		
[o.18]	Contact input signal 1 OFF detection timer	0	2		
[o.19]	Contact input signal 2	OFF	OFF		
[o.20]	Contact input signal 2 type	ALT	-		
[o.21]	Contact input signal 2 delay timer (time delay) of reading	0	-		
[o.22]	Contact input signal 2 OFF detection timer	0	-		

* Example: Connect flow switch A to contact input signal 1 in local mode.

Chapter 4 Starting the Product

CAUTION



Only people who have sufficient knowledge and experience about the product and its accessories are allowed to start and stop the product.

4.1 Before Starting

Check the following items before starting the product.

■ Installation conditions

- Check the product is installed horizontally.
- Check that there are no heavy objects on the product, and the external piping is not applying excessive force to the product.

■ Connection of cables

- Check the power, ground and communications (optional) cables are correctly connected.

■ Circulating fluid

- Check proper connection of piping at inlet and outlet.

■ Facility water piping (For water-cooled type)

- Check proper connection of piping at the facility water inlet and outlet.
- Check that the facility water source is in operation.
- Check that the facility water circuit is not shut off by valves

CAUTION



The facility water should be checked for whether or not it satisfies the water quality standard described in “8.1 Control of Circulating Fluid Quality” and requirements specified in “9.1 Specifications List”.

[Tips]

The product is equipped with a water regulator, which does not allow the facility water to flow unless the product is started.

■ Automatic fluid filling piping (When option J [Automatic fluid filling] is selected)

- Confirm that the automatic fluid filling port piping is connected properly.

■ Over flow port piping (When option J [Automatic filling] is selected).

- This is necessary when automatic fluid filling function is used.

■ Fluid level indicator (for tank)

- Ensure that the fluid level is on “H”.

4.2 Preparation for Start

4.2.1 Power supply

Supply the power and turn on the breaker.

When the product is switched on, the operation panel displays the following conditions.

- The initial screen (HELLO screen) is displayed for 8 seconds on the operation display panel. Then, the display changes to the main screen which displays the circulating fluid outlet temperature.
- The set value of circulating fluid temperature is displayed as SV on the panel.
- The present value of circulating fluid temperature is displayed as PV on the panel.

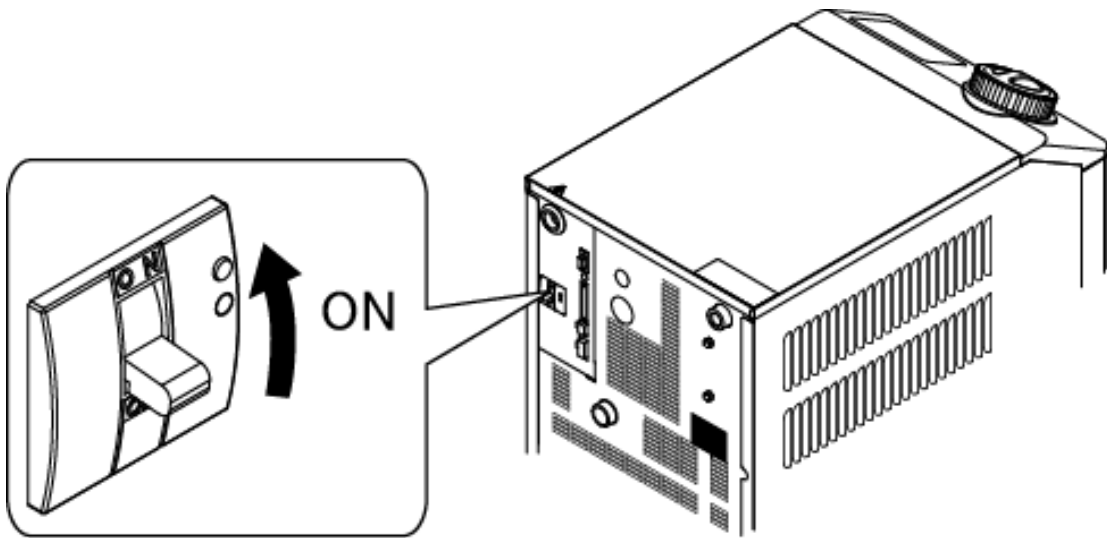

Fig. 4-1 Power supply

4.2.2 Setting of circulating fluid temperature

Press the [▼] and [▲] buttons on the operational panel to change the SV to required value.

When the temperature of the circulating fluid is set by the communication, refer to "Communication" in the supplementary operation manual.

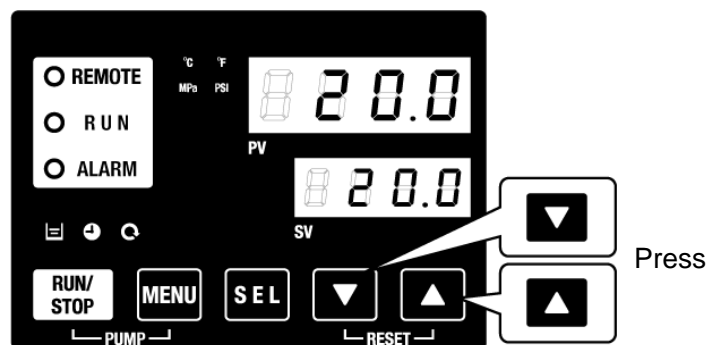

Fig. 4-2 Setting of circulating fluid temperature

4.3 Preparation of circulating fluid

When the circulating fluid tank is filled the user's machine and piping remains empty. In that condition, the circulating fluid flows out to the user's machine and piping and the tank level decreases and may require a refill. In that case, refill the circulating fluid in the following procedure.

1. Press the [PUMP] key on the operation display panel (press the [RUN/STOP] key and [MENU] key simultaneously).

The pump operates independently while the [PUMP] key is pressed. The [RUN] lamp (green) flashes while the pump is operating independently, and the circulating fluid in the tank is supplied to the customer's device and piping. This can be done to check for leakage, and to discharge air from the piping. If the fluid level in the tank reaches the lower limit, a buzzer will sound, and alarm no. "AL01 (tank fluid level is low)" is displayed on the digital display PV. The [ALARM] lamp (red) flashes, the [] lamp turns on, and the independent operation of the pump is stopped.

CAUTION

If leakage occurs due to faulty piping including an opened fitting of eternal piping, stop manual operation of the pump and fix the leak.

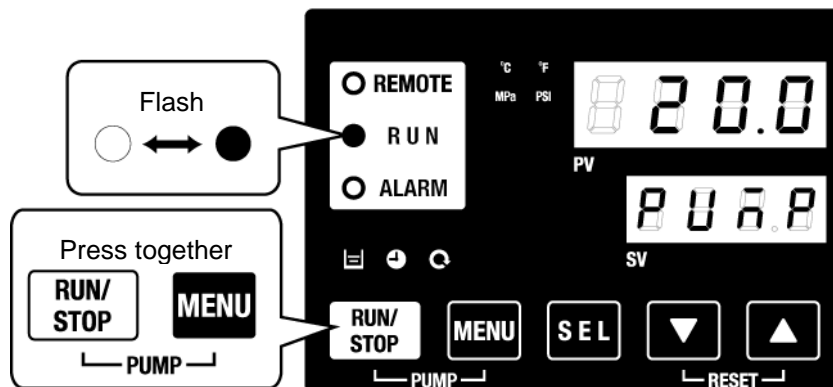

Fig. 4-3 Manual operation of the pump

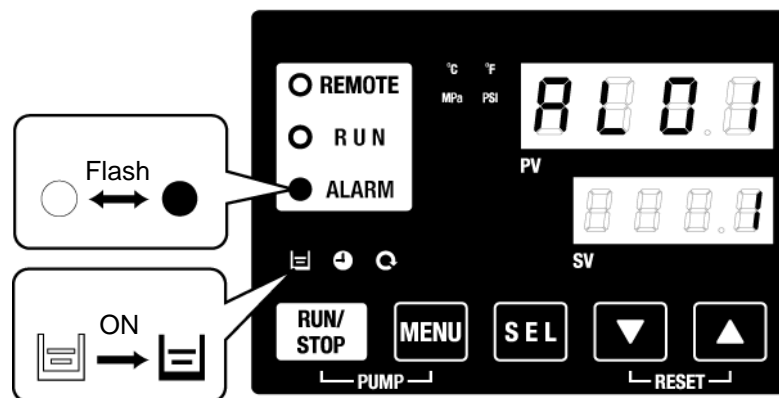

Fig. 4-4 Low tank level alarm

2. Press the [RESET] key ([▼] and [▲] keys simultaneously) to stop the alarm buzzer.

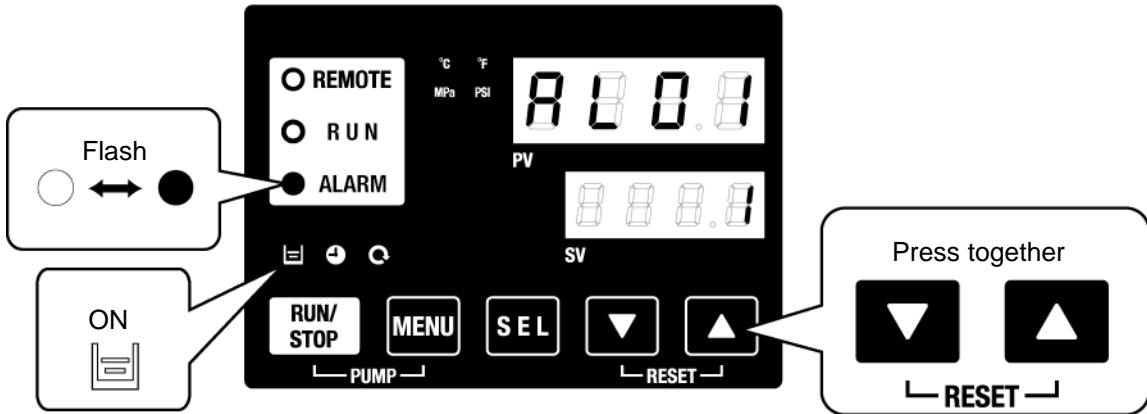

Fig. 4-5 Alarm receipt

CAUTION

Be sure to reset the alarm on the operation display panel of the alarm. Alarm reset is not accepted from any screen except the alarm display menu. Refer to 5.2.1 Key operations.

3. Open the tank lid and supply the circulating fluid up to the “H” mark on the tank.

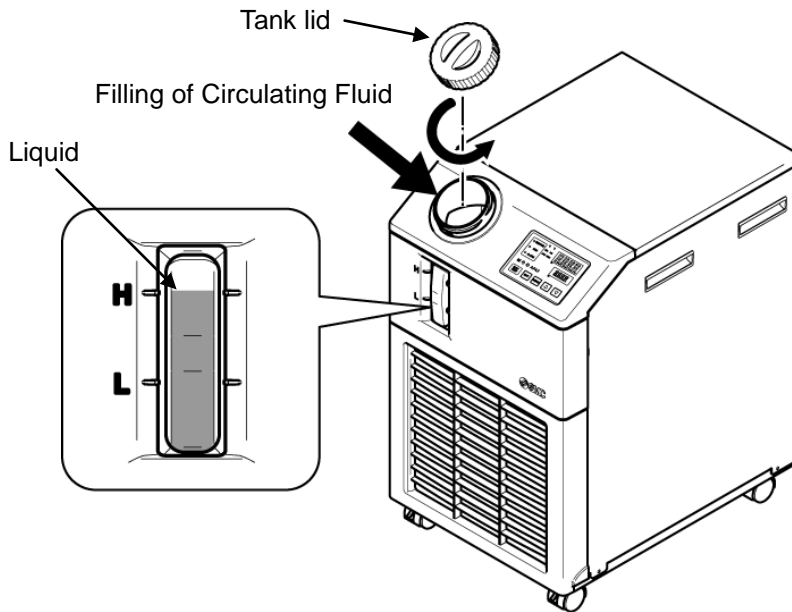

Fig. 4-6 Filling of Circulating Fluid

CAUTION



- Check the drain port is closed by the valve to prevent the supplied circulating fluid from draining out.
- Supply the circulating fluid up to the “H” mark on the tank. Operation will stop when the fluid level falls lower than “L”.

4. Press the [RESET] key ([▼] and [▲] keys simultaneously) to reset the alarm.

The alarm (tank fluid level is low) is reset, and the [ALARM] lamp and [≡] lamp are turned off. The display returns to the initial screen of the main menu: "Circulating fluid temp. / Circulating fluid set temp." Press the [PUMP] key (press [RUN/STOP] key and [MENU] key simultaneously) to start independent operation of the pump.

CAUTION

Be sure to reset the alarm on the operation display panel of the alarm. Alarm reset is not accepted from any screen except the alarm display menu. Refer to 5.2.1 Key operations.

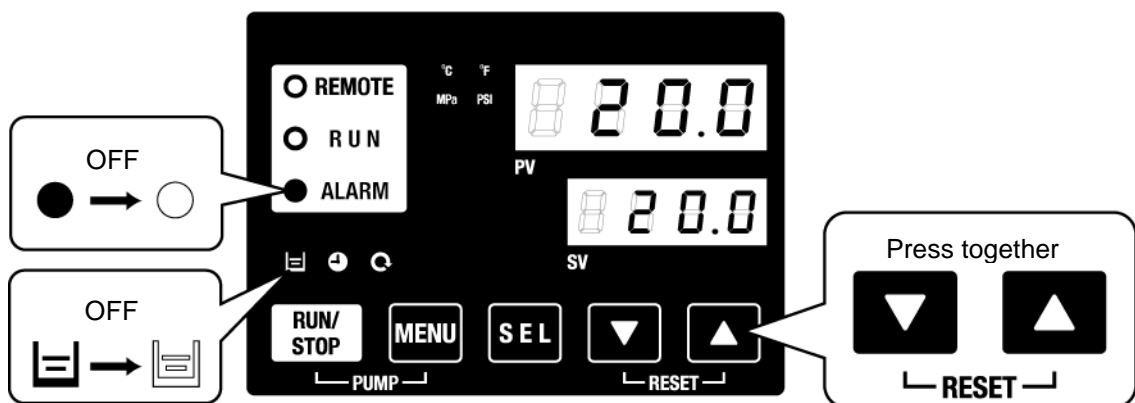



Fig. 4-7 Alarm release

5. Repeat steps 1 to 4 to supply the circulating fluid to the customer's device and piping. The tank level must be "H" on the tank liquid level indicator

4.4 Starting and Stopping

4.4.1 Starting the product

CAUTION

 **Allow at least five minutes before restarting the product.**

Before starting, check the items specified in “4.1 Before Starting”

If any alarm lamp remains on, refer to Chapter 7 Alarm indication and trouble shooting”

1. Press the [RUN/STOP] key on the operation panel.

The [RUN] lamp lights up (in green) and the product starts running. The circulating discharge temperature (PV) is controlled to the set temperature (SV).

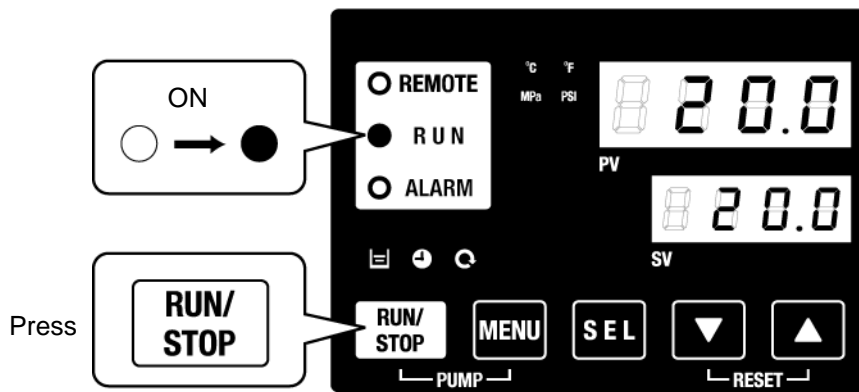

Fig. 4-8 Starting the product

CAUTION

When an alarm occurs Refer to “Chapter 7 Alarm indication and trouble shooting”

4.4.2 Stopping the product

1. Press the [RUN/STOP] button on the operation panel.

The [RUN] lamp on the operation panel flashes green at 1 second intervals, and continues operation to prepare to stop. After approx. 15 seconds, the [RUN] lamp goes off and the product stops.

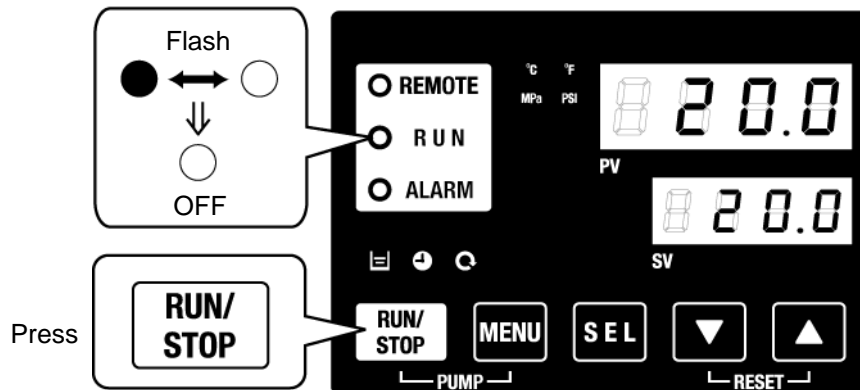

Fig. 4-9 Stopping the product

2. Turn off the power supply switch.

All LEDs go off.

WARNING



Be sure to shut off the breaker of the facility power supply (the user's machine power supply) before wiring. Also, drain the circulating fluid, etc. from the product in accordance with and put into storage properly (Referring to "8.4.1 Discharge of the circulating fluid".)

CAUTION



Except in case of emergency, do not turn off the breaker until the product has stopped completely. Doing so could cause failure.

4.5 Check items after starting

Check the following items after starting the product.

WARNING



When an Alarm is seen, press the [STOP] button and then turn off the breaker to stop the product, and turn off the breaker of the user's power supply to isolate the product.

- There is no leakage from piping.
- There is no drain of circulating fluid from the tank drain port.
- The circulating fluid pressure is within the specified range.
- The tank level is within the specified range.

4.6 Adjustment of Circulating Fluid

■ Flow adjustment

If the flow rate is less than 7L/min it will not be able to achieve the specified cooling capacity. The adjustment of flow rate should be performed using a manual bypass valve and monitoring the pressure or flow rate in the customer's device, referring to the recommended piping flow shown in Figure 3-13, until they reach the required value. (Not included in the package: Bypass Piping Set [HRS-BP004])

CAUTION



If the valve locates in circulating piping, do not fully close the valve (0L/min). The pump may be damaged.

Chapter 5 Display and setting of various functions

⚠ WARNING



Read and understand this manual carefully before changing the settings.

5.1 List of function

The product can have the displays and settings shown in table 5-1.

Table 5-1 List of function

NO	Function	Outline	Reference page
1	Main display	Displays the current temperature of the circulating fluid, discharge pressure of the circulating fluid/change the circulating fluid temperature.	5.3
2	Alarm display menu	Indicates alarm number when an alarm occurs.	5.4
3	Inspection monitor menu	Product temperature, pressure and accumulated operating time can be checked as daily inspection. Use these for daily inspection.	5.5
4	Key-lock	Keys can be locked so that set values cannot be changed by operator error.	5.6
5	Timer for operation start /stop	Timer is used to set the operation start/stop.	5.7
6	Signal for the completion of preparation	A signal is output when the circulating fluid temperature reaches the set temperature, when using contact input/output and serial communication.	5.8
7	Offset function	Use this function when there is a temperature offset between the discharge temperature of the thermo-chiller and the customer's device.	5.9
8	Reset after power failure	Start operation automatically after the power supply is turned on.	5.10
9	Anti-freezing function	Circulating fluid is protected from freezing during winter time or night time. Set beforehand if there is a risk of freezing.	5.11
10	Key click sound setting	Operation panel key sound can be set on/off.	5.12
11	Changing temp. unit	Temperature unit can be changed. Centigrade(°C) ↔ Fahrenheit(°F)	5.13
12	Changing pressure unit	Pressure unit can be changed. MPa ↔ PSI	5.14
13	Setting of alarm buzzer	Alarm sound can be set to on/off.	5.15
14	Alarm customizing	Operation during alarm condition and threshold values can be changed depending on the alarm type.	5.16
15	Data reset	Functions can be reset to the default settings (settings when shipped from the factory).	5.17
16	Accumulation time reset	Reset function when the pump, the fan, or the compressor is replaced. Accumulated time is reset.	5.18
17	Communication	This function is used for contact input/output or serial communication.	5.19
18	Option J [Automatic water-fill port]	This function is available for customer who selected option J [Automatic fluid filling] (Refer to P2-1 Name and Function of Parts)	6.1
19	Option [Drain pan set]	This function is available for customer who purchased drain pan set (part no.: HRS-WL002).	6.2
20	Option [Electric resistivity / conductivity sensor set]	This function is available for customer who purchased the electric resistivity/conductivity sensor set (part no.: HRS-DI001).	0

5.2 Function

5.2.1 Key operations

Fig. 5.2-1 “Key operation (1/2)” and “Key operation (2/2)” shows the operation of keys of the thermo-chiller.

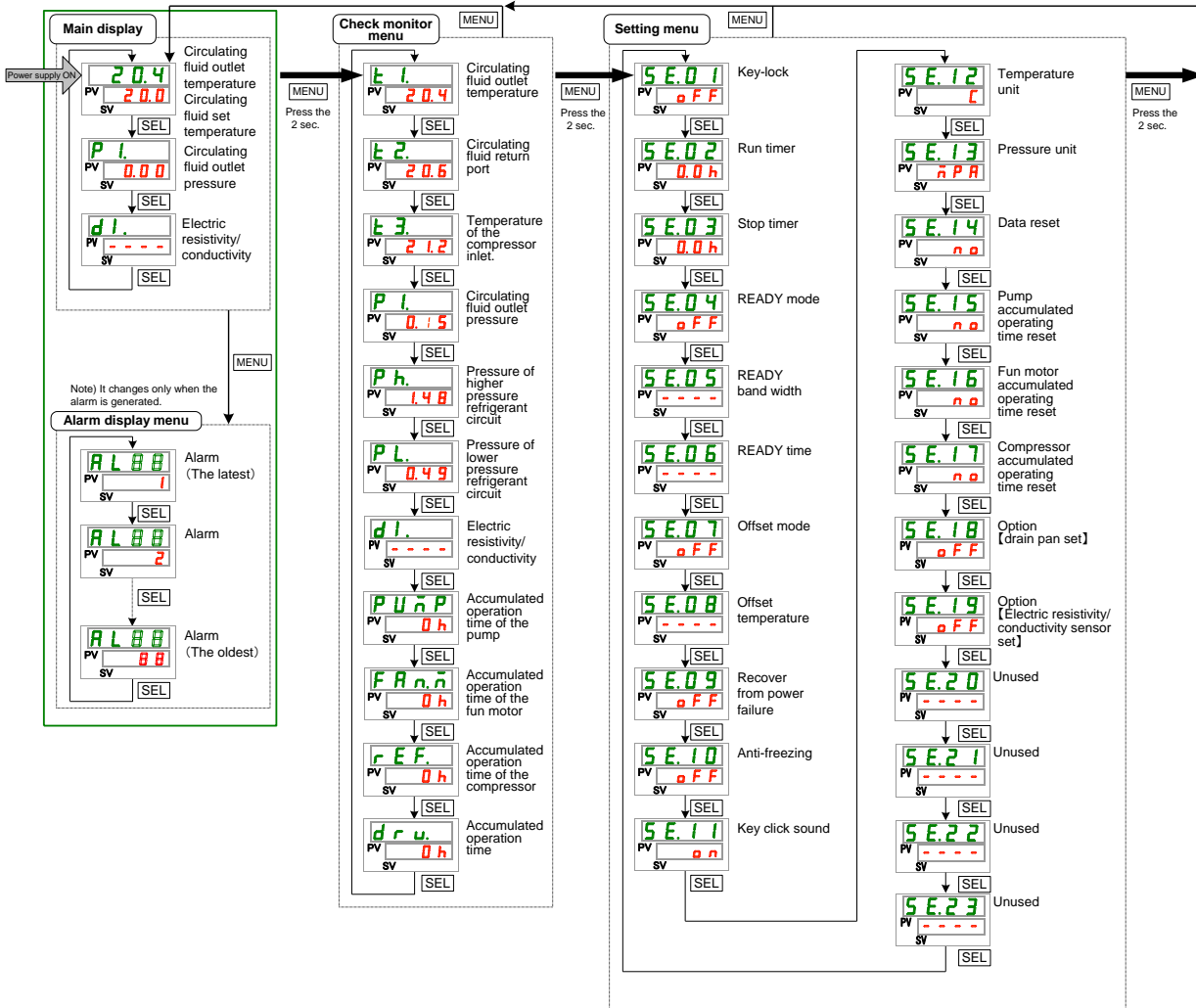

Fig. 5.2-1 Key operation (1/2)

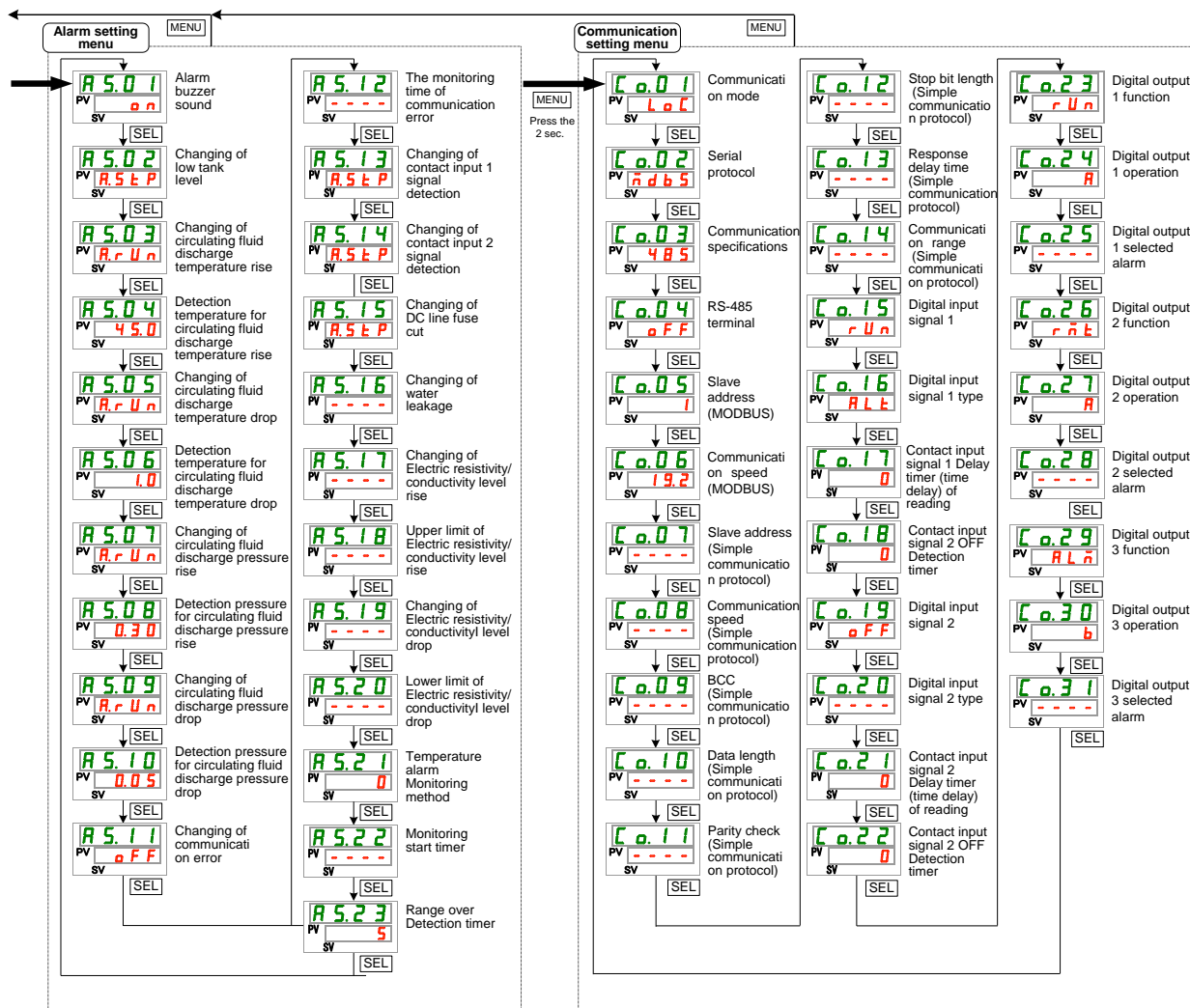

Fig. 5.2-2 Key operation (2/2)

5.2.2 List of parameters

Table 5.2-1“List of parameter (1/3)” and Table 5.2-3“List of parameter (3/3)” show the parameters of the thermo-chiller.

Table 5.2-1 List of parameter (1/3)

Display	Item	Initial value (Default setting)	Reference page	Category	
Temperature P I. d I.	Circulating fluid temperature(TEMP PV)		5.3	Main display	
	Circulating fluid set temperature(TEMP SV)	20 °C (68 °F)			
	Circulating fluid outlet pressure				
	Electric resistivity/conductivity				
AL x x	Alarm no.		5.4	Alarm display menu	
E 1. E 2. E 3. P I. P h. P L. d I. P U n P F R n n r E F. d r u.	Circulating fluid outlet temperature Circulating fluid return port temperature Temperature of the compressor inlet. Circulating fluid outlet pressure Pressure of higher pressure refrigerant circuit Pressure of lower pressure refrigerant circuit Electric resistivity Accumulated operation time of the pump Accumulated operation time of the fun motor Accumulated operation time of the compressor Accumulated operation time		5.5	Check monitor menu	
5 E.0 1	Key-lock	OFF			5.6
5 E.0 2	Run timer	0.0H			
5 E.0 3	Stop timer	0.0H			5.7
5 E.0 4	READY mode	OFF			
5 E.0 5	READY band width	0.0°C(0.0 °F)			5.8
5 E.0 6	READY time	10 sec			
5 E.0 7	Offset mode	OFF			5.9
5 E.0 8	Offset temperature	0.0 °C (0.0 °F)			
5 E.0 9	Recover from power failure	OFF			5.10
5 E.1 0	Anti-freezing	OFF	5.11		
5 E.1 1	Key click sound	ON	5.12		
5 E.1 2	Temperature unit	C	5.13		
5 E.1 3	Pressure unit	MPa	5.14		
5 E.1 4	Data reset	NO	5.17		
5 E.1 5	Pump accumulated operating time reset	NO	5.18		
5 E.1 6	Fun motor accumulated operating time reset	NO			
5 E.1 7	Compressor accumulated operating time reset	NO			
5 E.1 8	Option【Drain pan set】	OFF	6.2		
5 E.1 9	Option【 Electric resistivity/conductivity sensor set】	OFF	0		
5 E.2 0	Unused	-	-		
5 E.2 1	Unused	-	-		
5 E.2 2	Unused	-	-		
5 E.2 3	Unused	-	-		

Table 5.2-2 List of parameter (2/3)

Display	Item	Initial value (Default setting)	Reference page	Category	
R 5.01	Alarm buzzer sound	ON	5.15	Alarm setting menu	
R 5.02	Changing of low tank level	A.STP	5.16		
R 5.03	Changing of circulating fluid discharge temperature rise	A.RUN			
R 5.04	Detection temperature for circulating fluid discharge temperature rise	45.0 °C (113.0 ° F)			
R 5.05	Changing of circulating fluid discharge temperature drop	A.RUN			
R 5.06	Detection temperature for circulating fluid discharge temperature drop	1.0 °C (33.8 ° F)			
R 5.07	Changing of circulating fluid discharge pressure rise	A.RUN			
R 5.08	Detection pressure for circulating fluid discharge pressure rise	0.30MPa(44PSI)*			
R 5.09	Changing of circulating fluid discharge pressure drop	A.RUN			
R 5.10	Detection pressure for circulating fluid discharge pressure drop	0.05MPa(7PSI)			
R 5.11	Changing of communication error	OFF			
R 5.12	The monitoring time of communication error	30 sec			
R 5.13	Unused	-			
R 5.14	Changing of Contact input signal 2 detection	A.STP			
R 5.15	Changing of DC line fuse cut	A.STP			
R 5.16	Changing of water leakage	A.STP			
R 5.17	Changing of upper limit of electric resistivity/conductivity	A.RUN			
R 5.18	Upper limit of electric resistivity/conductivity	<input type="checkbox"/>			
R 5.19	Changing of lower limit of electric resistivity/conductivity	OFF			
R 5.20	Lower limit of electric resistivity/conductivity	<input type="checkbox"/>			
R 5.21	Temperature alarm Monitoring method	0			
R 5.22	Monitoring start timer	----			
R 5.23	Range over Detection timer	5			
C 0.01	Communication mode	LOC	5.19	Communication setting menu	
C 0.02	Serial protocol	MDBS			
C 0.03	Communication specifications	485			
C 0.04	RS-485 terminal	OFF			
C 0.05	Mod bus	Slave address			1
C 0.06		Communication speed			19.2
C 0.07	Simple communication protocol	Slave address			1
C 0.08		Communication speed			9.6
C 0.09		BCC			ON
C 0.10		Data length			8BIT
C 0.11		Parity check			NON
C 0.12		Stop bit length			2BIT
C 0.13		Response delay time			0
C 0.14	Communication range	RW			

Table 5.2-3 List of parameter (3/3)

Display	Item	Initial value (Default setting)	Reference page	Category
[o.15]	Contact input signal 1	RUN	5.19	Communication setting menu
[o.16]	Contact input signal 1 type	ALT		
[o.17]	Unused	-		
[o.18]	Unused	-		
[o.19]	Contact input signal 2	OFF		
[o.20]	Contact input signal 2 type	ALT		
[o.21]	Contact input signal 2 delay timer (time delay) of reading	0		
[o.22]	Contact input signal 2 OFF detection timer	0		
[o.23]	Contact output 1 function	RUN		
[o.24]	Contact output 1 operation	A		
[o.25]	Selected for contact output 1	AL.01		
[o.26]	Contact output 2 function	RMT		
[o.27]	Contact output 2 operation	A		
[o.28]	Selected for contact output 2.	AL.01		
[o.29]	Contact output 3 function	ALM		
[o.30]	Contact output 3 operation	B		
[o.31]	Selected for contact output 3	AL.01		

* Option T [High pump head] : 0.50MPa(73PSI)

5.3 Main screen

5.3.1 Main screen

Displays the current temperature and the set temperature of the circulating fluid. The set temperature can be changed on this screen.

5.3.2 Display on the main screen

The display on the main screen is as follows.

Current discharge temperature of circulating fluid Display

1. Turn ON the power supply switch.

Current temperature and set temperature are displayed on the digital display.
Alarm display screen (See 5.4) appears when an alarm is generated.

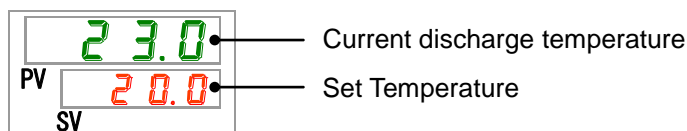

Circulating fluid temperature Set

2. Change the set temperature by pressing the [▼][▲] key.
After changing the set temperature, set it by pressing the [SEL] key.
*The set value flashes while it is being changed.
*If [SEL] key is not pressed, the value is reset after 3 sec.

Circulating fluid discharge pressure Display

3. Press the [SEL] key.

The discharge pressure of the circulating fluid is displayed on the digital display.

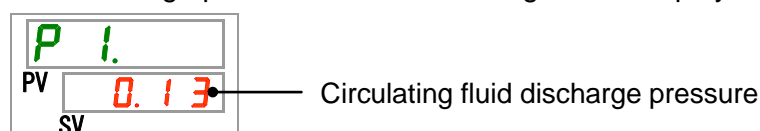

Electric resistivity/conductivity Display

4. Press the [SEL] key.

The electric resistivity/conductivity is displayed on the digital display.



* This function is available for customers who have purchased the electric resistivity/conductivity sensor set which is a separately sold accessory. Refer to the Operation Manual attached to these optional accessories for details.

5.4 Alarm display menu

5.4.1 Alarm display menu

The alarm display screen appears when an alarm is generated.

- * The alarm display menu cannot be accessed when no alarm has been generated.
- * Refer to “Chapter 7 Alarm indication and trouble shooting” for the content of alarms.

5.4.2 Content of display of alarm display menu

The alarm display screen appears when an alarm is generated.

When multiple alarms are generated, the latest alarm is displayed on the screen.

Each time the [SEL] key is pressed, the alarms are displayed in order, starting from the latest one.

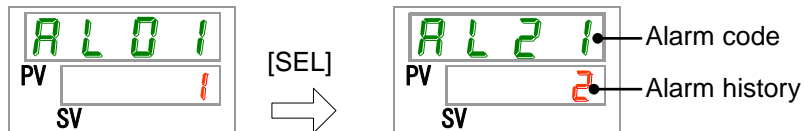

The main screen is displayed when the alarm is reset.



The main screen is displayed when [MENU] key is pressed while an alarm is output.



The alarm display screen is displayed if [MENU] key is pressed again.

5.5 Inspection monitor menu

5.5.1 Inspection monitor menu

As a part of the daily inspection, the temperature, pressure and accumulated operating time can be checked.

Please use this for confirmation of your daily inspection.

5.5.2 Checking of the Inspection monitor menu

The table below explains the check items of the inspection monitor menu.

Table 5.5-1 List of check items of Inspection monitor menu

Display	Item	Contents
E 1.	Circulating fluid outlet temperature	Displays the temperature of the circulating fluid outlet. This temperature does not take offset into consideration.
E 2.	Circulating fluid return port temperature	Displays the temperature of the circulating fluid return.
E 3.	Temperature of the inlet of the compressor	Displays the temperature of the inlet of the compressor.
P 1.	Circulating fluid outlet pressure	Displays the circulating fluid outlet pressure at the outlet.
P h.	Pressure of higher pressure refrigerant circuit	Displays the pressure of higher pressure side of the refrigerant circuit.
P L.	Pressure of lower pressure refrigerant circuit	Displays the pressure of lower pressure side of the refrigerant circuit.
d l.	Electric resistivity/conductivity	Displays the electric resistivity/conductivity.
P U ñ P	Accumulated operation time of the pump	Displays the accumulated operation time of the pump.
F R ñ ñ	Accumulated operation time of the fan motor	Displays the accumulated operation time of the fan motor. (For air-cooled type)
r E F.	Accumulated operation time of the compressor	Displays the accumulated operation time of the compressor.
d r u.	Accumulated operation time	Displays the accumulated operation time.

Check of the circulating fluid outlet temperature

1. Press and hold the [MENU] key for approx. 2 sec.

The temperature of the circulating fluid outlet 「E 1.」 is displayed on the digital display.

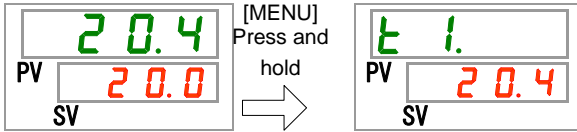

Displays the temperature of the circulating fluid at the outlet from which the fluid is fed to the customer's device. This temperature does not take temperature offset into consideration

Check of the circulating fluid inlet temperature

2. Press the [SEL] key once.

The temperature of the circulating fluid return is displayed on the digital display.

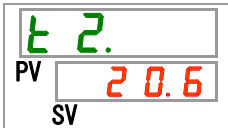

Displays the temperature of the circulating fluid returning from the customer's device.

Check of the temperature of the inlet of the compressor.

3. Press the [SEL] key once.

The temperature of the refrigerant circuit compressor inlet is displayed on the digital display.

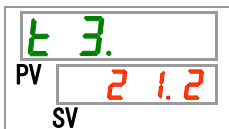

Displays the temperature of the compressor inlet.

Check of the circulating fluid outlet pressure

4. Press the [SEL] key once.

The circulating fluid outlet pressure is displayed on the digital display.

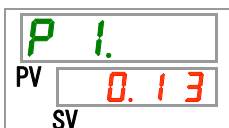

The pressure of the circulating fluid outlet from which the fluid is sent to the customer's device is displayed.

Check of the pressure of the higher pressure side of the refrigerant circuit

5. Press the [SEL] key once.

The pressure of higher pressure refrigerant circuit is displayed on the digital display.

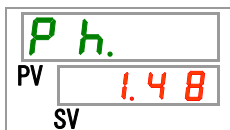

Displays the pressure of the higher pressure side of the refrigerant circuit.

Check of the pressure of the lower pressure side of the refrigerant circuit

6. Press the [SEL] key once.

The pressure of lower pressure refrigerant circuit is displayed on the digital display.

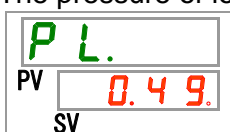

Displays the pressure of the lower pressure side of the refrigerant circuit.

Check of the electric resistivity/conductivity

7. Press the [SEL] key once.

The electric resistivity/conductivity is displayed on the digital display.

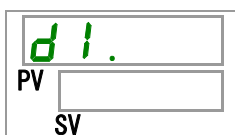

* This function is available for customers who have purchased the electric resistivity/conductivity sensor set which is a separately sold accessory. Refer to the Operation Manual attached to these optional accessories for details.

Check of the accumulated operation time of the pump

8. Press the [SEL] key once.

The accumulated operation time of the pump is displayed on the digital display.



Displays the accumulated operation time of the pump. Refer to the table below for the display.

Table 5.5-2 List of time display

Cumulative time	Indicated value
0h to 999h	0h to 999h
1,000h to 99,999h	1hh to 99hh
100,000h	Return to 0h

AL28 Pump maintenance alarm is generated when the accumulated operation time of the pump reaches 20,000 hours (20hh) or more. For details, refer to Chapter 7 Alarm indication and trouble shooting.

Check of the accumulated operation time of the fan motor

9. Press the [SEL] key once.

The accumulated operation time of the fan motor is displayed on the digital display.

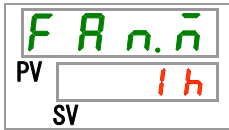

Displays the accumulated operation time of the fan motor. Refer to Table 5.5-2 for the display.

AL29 Fan motor maintenance alarm is generated when the accumulated operation time of the fan motor reaches 20,000 hours (20 h h) or more. For details, refer to Chapter 7 Alarm indication and trouble shooting.

Water-cooled refrigerated type does not have the fan motor. The accumulated time of the digital display shows " - - - - ". Also, AL29 fan motor maintenance alarm is not generated.

Check of the accumulated operation time of the compressor

10. Press the [SEL] key once.

The accumulated operation time of the compressor is displayed on the digital display.



Displays the accumulated operation time of the compressor. Refer to Table 5.5-2 for the display.

AL30 Compressor maintenance alarm is generated when the accumulated operation time of the compressor reaches 50,000 hours (50 h h) or more. For details, refer to Chapter 7 Alarm indication and trouble shooting.

Check of the accumulated operation time

11. Press the [SEL] key once.

The accumulated operation time is displayed on the digital display.

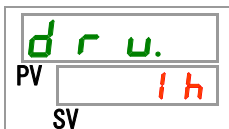

Displays the accumulated operation time. Refer to Table 5.5-2 for the display.

5.6 Key-lock

5.6.1 Key-lock

The keys can be locked to prevent the set values being changed by operator error. Operation can be started/stopped by the "RUN/STOP" key even while key-lock is set.

If you try to change the set value with "▲" and "▼" key while key-lock is set, "LoCk" is displayed for 1 sec. on the screen. The set value cannot be changed. (Refer to the figure below.)

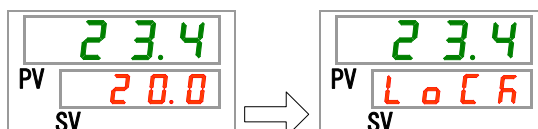

⚠ CAUTION



During key-lock setting, no other setting is available.
Release the key-lock setting for other setting.

5.6.2 Key-lock setting / checking

The table below explains the setting items of the key-lock function and the initial values.

Table 5.6-1 List of key-lock

Display	Item	Contents	Initial value (Default setting)
SE.O I	Key-lock	Sets key-lock. While key-lock setting is ON, no other setting is available.	OFF

1. Press and hold the [MENU] key for approx. 2 sec.

Repeat pressing until the setting display [SE.O I] for key-lock setting appears on the digital display

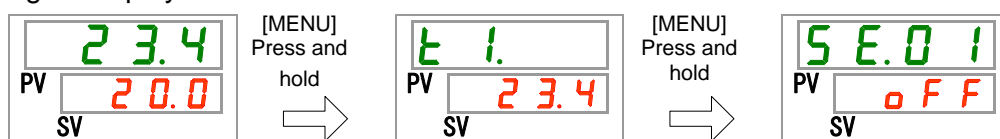

Key-lock setting and checking

2. Select "ON" from the table below with [▲] key or [▼] key, and confirm with "SEL".

Table 5.6-2 List of set value

Set value	Explanation	Initial value (Default setting)
o F F	Key-lock function OFF	○
o n	Key-lock function ON	

3. Press the [MENU] key once.

Return to the main screen (screen displaying the circulating fluid temperature).



5.7 Run timer, stop timer function

5.7.1 Run timer and stop timer function

This function starts or stops operation automatically when a set time has passed. The time can be set according to the customer's working hours. Set the circulating fluid temperature in advance.

[Run timer] is a function to start operation after a set time. [Stop timer] is a function to stop operation after a set time. It is possible to set both [Run timer] and [Stop timer]. The set time of both the [Run timer] and [Stop timer] can be up to 99.5 hours, in 0.5 hour units.

【When communication is used】

If the communication mode is DIO REMOTE, SERIAL mode, this function does not operate. DIO REMOTE, SERIAL mode operation/stop signal has priority.

●Run timer

- [Run timer] starts operation after the set time.

If the thermo-chiller is already operating or the pump is operating independently, this function does not operate even if the set time has passed.

Operation can start when the condition is normal and there is no alarm generated.

- The [⊕] lamp lights up when the run timer is set. The [⊖] lamp is turned off when the operation is started by the run timer.

The [⊖] lamp is not turned off if the Stop timer is set.

- The Run timer setting is reset when the main power supply is cut or a power failure occurs. Please reset.

●Stop timer

- The [⊖] lamp lights when the Stop timer is set. The [⊕] lamp is turned off if the operation is stopped by the Stop timer.

The [⊕] lamp is not turned off if the Run timer is set.

- The Stop timer setting is reset when the main power supply is cut or a power failure occurs. Please reset.

Timer setting example

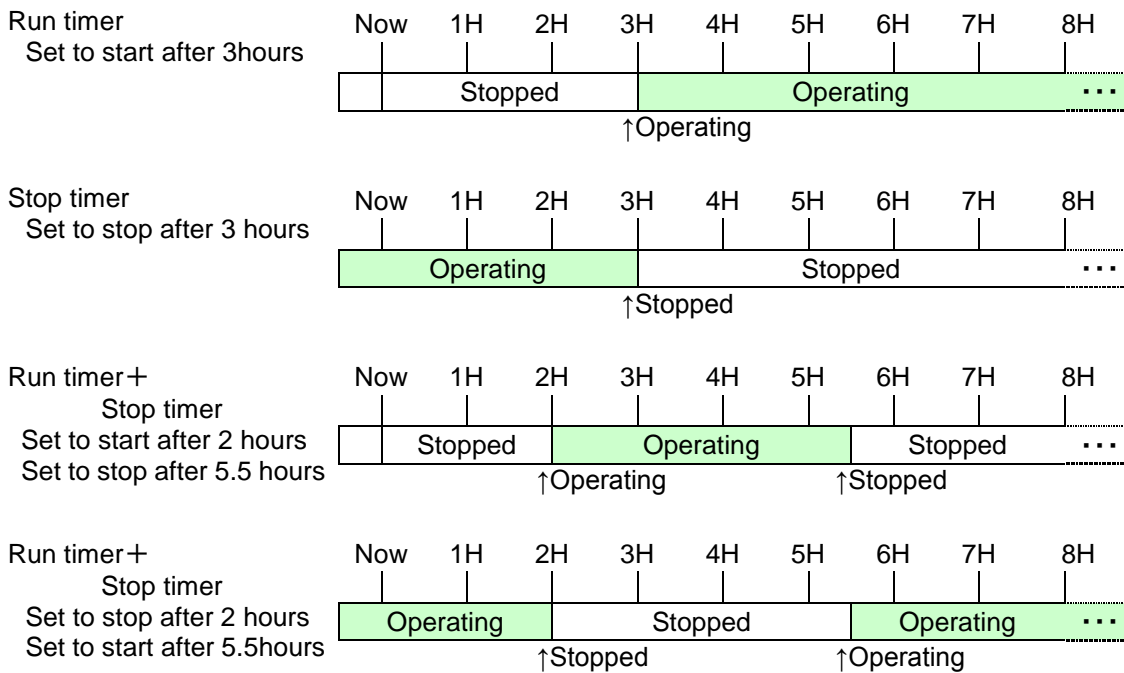

⚠ CAUTION

- **Set while the breaker is ON (while the power is supplied).**
- **The setting is released when operation is started or stopped by the timer. Resetting is necessary to use the timer next time.**
- **Run timer setting is released when the breaker or the customer's power supply facility is cut, or a power failure occurs. Please reset.**

5.7.2 Setting and checking of Run timer and stop timer function

The table below explains the setting items of the run/stop timer and the initial values.

Table 5.7-1 List of set run timer and stop timer

Display	Item	Contents	Initial value (Default setting)
SE.02	Run timer	Sets run timer.	0.0H
SE.03	Stop timer	Sets stop timer.	0.0H

This part explains the setting and checking items of both the run and stop timers. Please refer to the applicable items for the timer you wish to use.

1. Press and hold the [MENU] key for approx. 2 sec.

Repeat pressing the key until the setting screen for key-lock [SE.01] appears on the digital display.

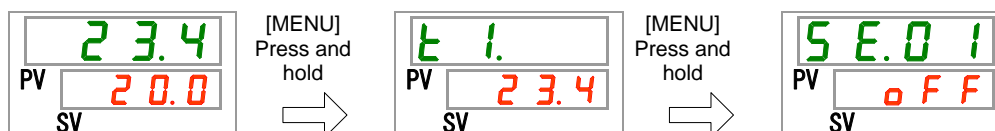

Run timer Setting and checking

2. Press the [SEL] key once.

The set screen of run timer is displayed on the digital display.



3. Select run timer from the table below with [▲] key or [▼] key, and confirm by pressing "SEL".

Table 5.7-2 List of set value

Set value	Explanation	Initial value (Default setting)
0.0 h	Timer OFF	○
0.5 h to 99.5 h	Operation starts after set time. Setting unit is 0.5 hour	

E.g. Set at 5:30pm the previous day. Operation starts 14 hours later (7:30am the next day).



Stop timer Setting and checking

4. Press the [SEL] key once.

The set screen of stop timer is displayed on the digital display.



5. Select stop timer from the table below with [▲] key or [▼] key, and confirm by pressing "SEL".

Table 5.7-3 List of set value

Set value	Explanation	Initial value (Default setting)
0.0 h	Timer OFF	○
0.5 h to 9.5 h	Operation stops after set time. Setting unit is 0.5 hour	

E.g. Set at 4:30pm. Operation stops 1 hour and 30 minutes later (at 6:00pm).



6. Press the [MENU] key once.

Return to the screen displaying the circulating fluid temperature.

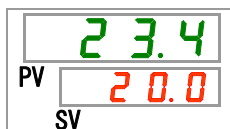

7. Once the run timer is set leave the power supply to the product on. The product will start automatically in the set time.

When the stop timer is set, leave the product running. The product will stop automatically in the set time.

5.8 Signal for completion of preparation (TEMP READY)

5.8.1 Signal for completion of preparation (TEMP READY)

This function sets the band width for the circulating fluid set temperature (upper/lower temperature range) in order to notify the customer by communication that the circulating fluid temperature has reached the band range (upper/lower temperature range). The default setting of this function is "OFF".

[Tips]

This function is available when contact input/output and serial communication is used. Refer to the Communications Operation Manual for more details.

An example is shown below.

- Circulating fluid set temperature : 20 °C
- READY band width (upper/lower temperature range) : ±2 °C
- READY time : 60 sec.

Preparation is completed 60 seconds after the circulating fluid temperature reaches 18°C to 22°C.

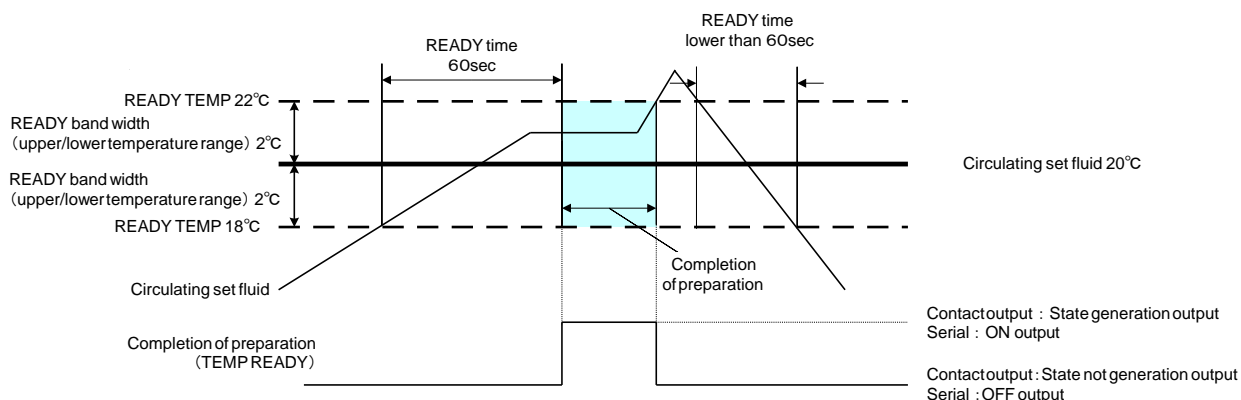

5.8.2 Signal for completion of preparation (TEMP READY) setting / checking

The table below shows the explanation of and initial value of set items of signal for completion of preparation (TEMP. READY)

Table 5.8-1 List of set Signal for completion of preparation (TEMP READY)

Display	Item	Contents	Initial value (Default setting)
SE.04	READY mode	Sets signal for completion of preparation (TEMP READY)	OFF
SE.05	READY band width (upper/lower temperature range)	Sets temperature of signal for completion of preparation.	0.0°C
SE.06	READY time	Sets time of signal for completion of preparation.	10 sec

1. Press and hold the [MENU] key for approx. 2 sec.

Repeat pressing the key until the setting screen for key-lock [SE.01] appears on the digital display.



READY mode Setting and checking

2. Press the [SEL] key 3 times.

The set screen of ready mode is displayed on the digital display.

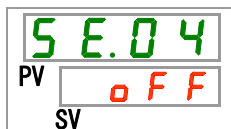

3. Select [ON] from the table below with [▲] key or [▼] key, and confirm by pressing "SEL".

Table 5.8-2 List of set value

Set value	Explanation	Initial (Default setting)
OFF	Signal for completion of preparation (TEMP READY) function OFF	○
ON	Signal for completion of preparation (TEMP READY) function ON	

READY band width setting and checking

4. Press the [SEL] key once.
The set screen of READY band width (upper/lower temperature range) is displayed on the digital display.



- 5.** Select READY band width (upper/lower temperature range) from the table below with [▲] key or [▼] key, and confirm by pressing “SEL”.

Table 5.8-3 List of set value

Set value	Explanation	Initial (Default setting)
- - - -	Setting and checking are not available when READY mode setting is OFF.	
Centigrade 0.0 to 5.0	Set READY band width (upper/lower temperature range) for the circulating fluid temperature	0.0
Fahrenheit 0.0 to 9.0	Temperature unit is Centigrade : Setting unit is 0.1°C Temperature unit is Fahrenheit : Setting unit is 0.1°F	0.0

READY time Set and checking

- 6.** Press the [SEL] key once.

The set screen of READY time is displayed on the digital display.



- 7.** Select READY time from the table below with [▲] key or [▼] key, and confirm by pressing “SEL”.

Table 5.8-4 List of set value

Set value	Explanation	Initial value (Default setting)
- - - -	Setting and checking are not available when READY mode setting is OFF.	
10 to 9999	Sets ultimate time. Set unit is 1 sec.	10

- 8.** Press the [MENU] key once.

Return to the main screen (screen displaying the circulating fluid temperature).

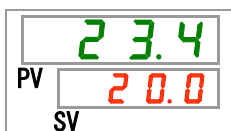

5.9 Offset function

5.9.1 Offset function

This function controls the circulating fluid discharge temperature with offset. Temperature offset may occur between the thermo-chiller and the customer's device depending on the installation environment. To correct the temperature offset, three types of offset functions are available (MODE1 to 3). The default setting of this function is "OFF".

[When communication is used]

The circulating fluid temperature sent by serial communication is the circulating fluid temperature which is displayed on the thermo-chiller (the circulating fluid temperature after offset).

●Example of temperature offset

The discharge temperature of the circulating fluid is 30°C, but the fluid temperature in the customer's device is 29°C because of heat radiation during sending of the fluid.

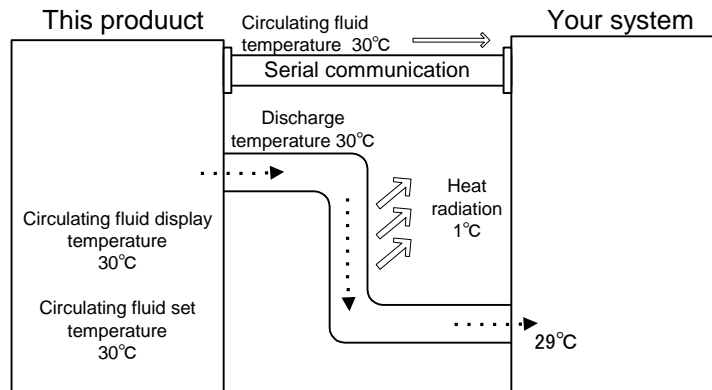

MODE	Explanation
MODE1	Control the temperature so that the discharge temperature of the circulating fluid is circulating fluid set temperature + offset temperature. Circulating fluid temperature indicates the circulating fluid discharge temperature.
MODE2	Control the temperature so that the discharge temperature of the circulating fluid is circulating fluid set temperature. Circulating fluid temperature indicates the circulating fluid discharge temperature + offset temperature.
MODE3	Control the temperature so that the discharge temperature of the circulating fluid is circulating fluid set temperature + offset temperature. Circulating fluid temperature indicates the circulating fluid discharge temperature - offset temperature.
OFF	Control the temperature so that the discharge temperature of the circulating fluid is circulating fluid temperature set value.

■ Example of MODE 1

When the offset temperature is 1°C, the thermo-chiller controls the temperature aiming at 31°C (circulating fluid set temperature + offset temperature.) Even if the discharge temperature is 31°C, the circulating fluid temperature is 30°C at the customer's device because of 1°C of heat radiation during sending of the fluid. Recirculating fluid display temperature and communication data is 31°C.

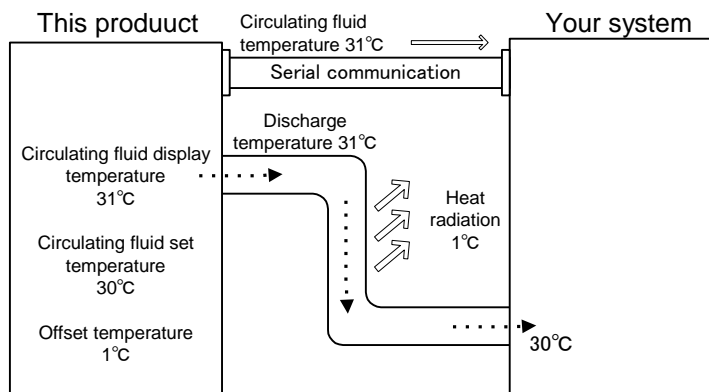

■ Example of MODE 2

When the offset temperature is -1°C, circulating fluid display temperature and the communication data is 29°C (circulating fluid discharge temperature + offset temperature), and matches the circulating fluid temperature of the customer's device.

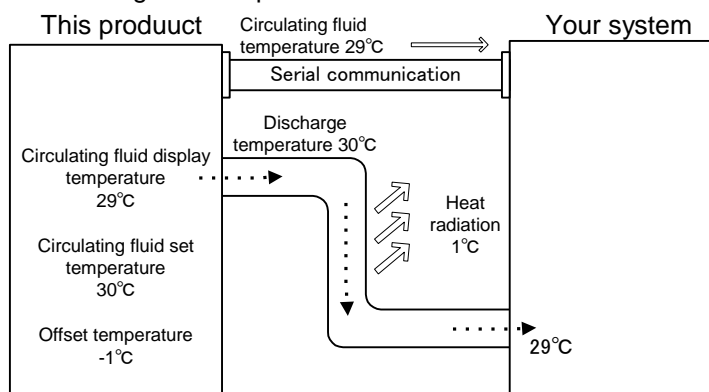

■ Example of MODE 3

When the offset temperature is 1°C, the thermo-chiller controls the temperature aiming at 31°C (circulating fluid set temperature + offset temperature) Even if the discharge temperature is 31°C, the circulating fluid temperature is 30°C at the customer's device because of 1°C of heat radiation during sending of the fluid. The circulating fluid display temperature and the communication data is 30°C (circulating fluid discharge temp. - offset temp.), and matches the circulating fluid temperature of the customer's device.

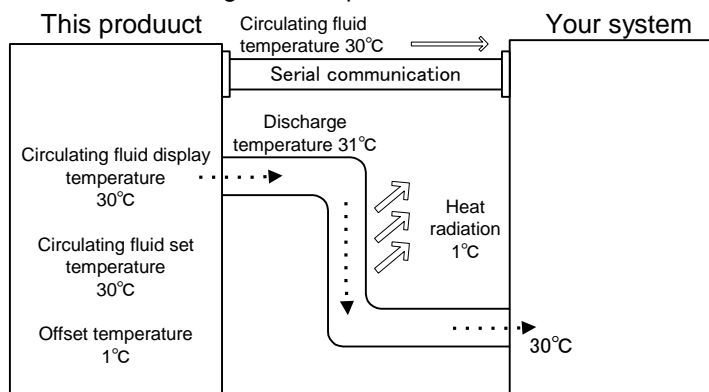

5.9.2 Offset function setting and checking

The table below explains the setting items of the offset function and the initial values.

Table 5.9-1 List of set offset function

Display	Item	Contents	Initial (Default setting)
SE.07	Offset mode	Sets offset mode.	OFF
SE.08	Offset temperature	Sets offset temperature.	0.0 °C

1. Press and hold the [MENU] key for approx. 2 sec.

Repeat pressing the key until the setting screen for key-lock [SE.01] appears on the digital display.

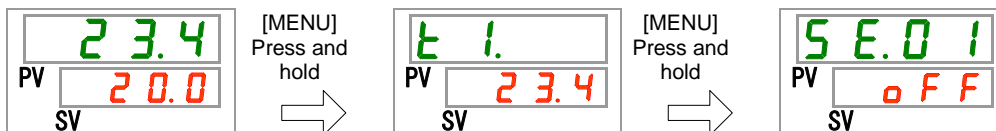

Offset mode Setting and checking

2. Press the [SEL] key 6 times.

The set screen of offset mode is displayed on the digital display.



3. Select offset mode from the table below with [▲] key or [▼] key, and confirm by pressing "SEL".

Table 5.9-2 List of set value

Set value	Explanation	Initial value (Default setting)
OFF	Offset function OFF	○
nd1	Offset mode 1	
nd2	Offset mode 2	
nd3	Offset mode 3	

Offset temperature Setting and checking

4. Press the [SEL] key once.

The set screen of offset temperature is displayed on the digital display.

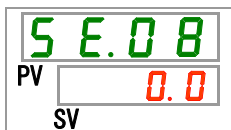

5. Select offset temperature from the table below with [▲] key or [▼] key, and confirm by pressing "SEL".

Table 5.9-3 List of set value

Set value	Explanation	Initial (Default setting)
----	Setting and checking are not available when offset mode setting is OFF.	
Centigrade - 20.0 to 20.0	Sets offset temperature. Temperature unit is Centigrade : Setting unit is 0.1°C	0.0
Fahrenheit - 36.0 to 36.0	Temperature unit is Fahrenheit : Setting unit is 0.1°F	0.0

CAUTION



- This function controls the offset temperature to the circulating fluid discharge temperature
- Control range of the circulating fluid temperature is 5.0°C to 40.0°C (41.0°F to 104.0°F).
- When the circulating fluid temperature is set to 5.0°C (41°F) and the offset temperature to -20.0°C (-36.0°F), the offset temperature is automatically adjusted to 0.0 °C (0.0°F) depending on the offset mode.

6. Press the [MENU] key once.

Return to the main screen (screen displaying the circulating fluid temperature).

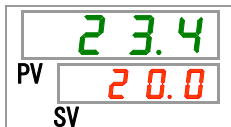

5.10 Function to recover from power failure

5.10.1 Function to recover from power failure

When the power supply is cut due to power failure etc., this function restarts the operation when the power supply recovers, retaining the conditions before the power cut.

【When communication is used】

If the communication mode is DIO REMOTE, SERIAL mode (MODBUS), this function does not start. The signal of start/stop of DIO REMOTE SERIAL mode (MODBUS) has priority.

The [Ⓞ] lamp lights when the power failure recovery is set. The default setting of this function is "OFF".

5.10.2 Function to recover from power failure setting and checking

The table below explains the setting items of the power recovery function and the initial values.

Table 5.10-1 List of set function to recover from power failure

Display	Item	Contents	Initial value (Default setting)
SE09	Recover from power failure	Sets recover from power failure.	OFF

1. Press and hold the [MENU] key for approx. 2 sec.

Repeat pressing the key until the setting screen for key-lock [SE01] appears on the digital display.

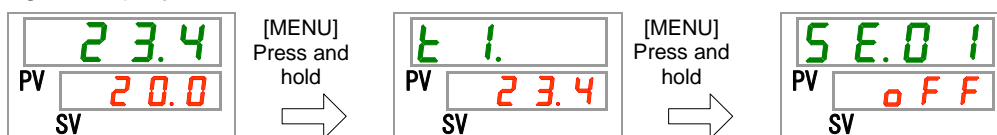

Recover from power failure Setting and checking

2. Press the [SEL] key 8 times.

The set screen of recover from power failure is displayed on the digital display.

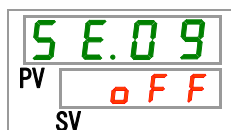

3. Select recover from power failure from the table below with [▲] key or [▼] key, and confirm by pressing "SEL".

Table 5.10-2 List of set value

Set value	Explanation	Initial value (Default setting)
OFF	Function to recover from power failure OFF	○
ON	Function to recover from power failure ON	

4. Press the [MENU] key once.

Return to the main screen (screen displaying the circulating fluid temperature).



5.11 Anti-freezing function

5.11.1 Anti-freezing function

The product can prevent the circulating fluid from freezing during winter time. If there is a possibility of the circulating fluid freezing due to changes in the installation and operating environment (operating period and weather), set the protection in advance.

- If the circulating fluid temperature falls below 3 °C, the pump will start operating automatically.
- The heat generated by the pump operation will warm up the circulating fluid.
When the circulating fluid temperature reaches 5 °C or higher, the pump will stop operating automatically.
- As a result, the circulating fluid maintains a temperature of between 3 °C and 5 °C, preventing freezing.

If the anti-freezing function is set, [RUN] lamp flashes for 2 sec. during waiting (pump does not operate). The [RUN] lamp flashes at 0.3sec. Intervals during the automatic operation of the pump. The default setting of this function is "OFF".

CAUTION



- This function starts in stand-by condition (power supply switch is ON).
- Fully open the valve or manual bypass valve arranged by the customer so that the circulating fluid can circulate when the pump starts automatic operation.
- In extremely cold weather conditions, the heat generated by the pump as described above may not be enough to prevent freezing.

CAUTION



- During the automatic operation, the pump does not stop even if you press "RUN/STOP" key.
- In an emergency, stop operation by shutting off the power supply.

5.11.2 Anti-freezing function setting and checking

The table below explains the setting items of the anti-freezing function and the initial values.

Table 5.11-1 List of set anti-freezing function

Display	Item	Contents	Initial value (Default setting)
SE.10	Anti-freezing	Sets anti-freezing	OFF

1. Press and hold the [MENU] key for approx. 2 sec.

Repeat pressing the key until the setting screen for key-lock [SE.01] appears on the digital display.

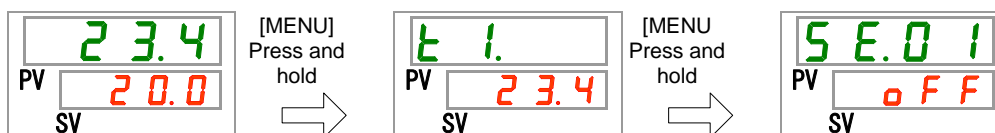

Anti-freezing Setting and checking

2. Press the [SEL] key 9 times.

The set screen of anti-freezing is displayed on the digital display.

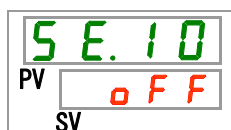

3. Select anti-freezing from the table below with [▲] key or [▼] key, and confirm by pressing "SEL".

Table 5.11-2 List of set value

Set value	Explanation	Initial value (Default setting)
OFF	Anti-freezing function OFF	○
ON	Anti-freezing function ON	

4. Press the [MENU] key once.

Return to the main screen (screen displaying the circulating fluid temperature).

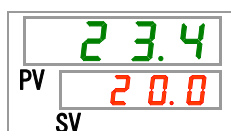

5.12 Key click sound setting

5.12.1 Key click sound setting

Set whether or not a click sound is made when keys on the operation panel are pressed.

The default setting is key sound “on”.

5.12.2 Key click sound setting and checking

The table below explains the setting items of the key click sound and the initial values.

Table 5.12-1 List of set key click sound

Display	Item	Contents	Initial value (Default setting)
SE.11	Key click sound	Sets key click sound.	ON

1. Press and hold the [MENU] key for approx. 2 sec.

Repeat pressing the key until the setting screen for key-lock [SE.01] appears on the digital display.

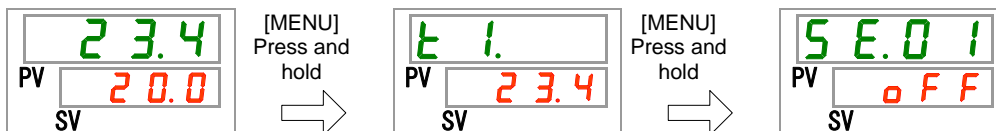

Key click sound Setting and checking

2. Press the [SEL] key 10 times.

The set screen of key click sound is displayed on the digital display.

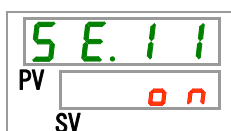

3. Select key click sound from the table below with [▲] key or [▼] key, and confirm by pressing “SEL”.

Table 5.12-2 List of set value

Set value	Explanation	Initial value (Default setting)
OFF	No key click sound	
ON	Key click sounds	○

4. Press the [MENU] key once.

Return to the main screen (screen displaying the circulating fluid temperature).

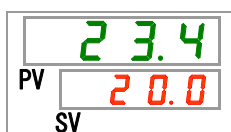

5.13 Temperature unit switching

5.13.1 Temperature unit switching

The temperature unit of the thermo-chiller can be set to centigrade ($^{\circ}\text{C}$) or Fahrenheit ($^{\circ}\text{F}$). This setting determines the temperature unit which is displayed/output. The default setting is centigrade ($^{\circ}\text{C}$).

-This feature is not valid with Option W, the unit is fixed at centigrade ($^{\circ}\text{C}$).

5.13.2 Temperature unit switching setting and checking

The table below explains the setting items of the temperature unit switching and the initial values.

Table 5.13-1 List of set temperature unit switching

Display	Item	Contents	Initial value (Default setting)
SE.12	Temperature unit	Sets temperature unit.	$^{\circ}\text{C}$

1. Press and hold the [MENU] key for approx. 2 sec.

Repeat pressing the key until the setting screen for key-lock [SE.01] appears on the digital display.

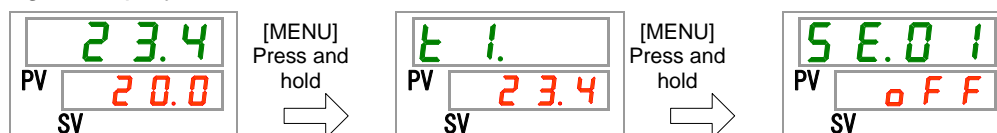

Temperature unit Setting and checking

2. Press the [SEL] key 11 times.

The set screen of temperature unit is displayed on the digital display.

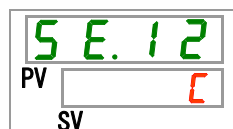

3. Select temperature unit from the table below with [\blacktriangle] key or [\blacktriangledown] key, and confirm by pressing "SEL".

Table 5.13-2 List of set value

Set value	Explanation	Initial value (Default setting)
C	Sets temperature unit is centigrade ($^{\circ}\text{C}$).	○
F	Sets temperature unit is fahrenheit ($^{\circ}\text{F}$)	

4. Press the [MENU] key once.

Return to the main screen (screen displaying the circulating fluid temperature).

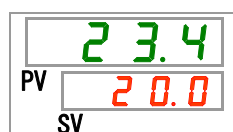

5.14 Pressure unit switching

5.14.1 Pressure unit switching

The pressure unit of the thermo-chiller can be set to MPa or PSI. This setting determines the pressure unit which is displayed/output. The default setting is MPa.

-This feature is not valid with Option W, the unit is fixed at MPa.

5.14.2 Pressure unit switching setting and checking

The table below explains the setting items of the pressure unit switching and the initial values.

Table 5.14-1 List of set Pressure unit switching

Display	Item	Contents	Initial value (Default setting)
SE.13	Pressure unit	Sets pressure unit.	MPa

1. Press and hold the [MENU] key for approx. 2 sec.

Repeat pressing the key until the setting screen for key-lock [SE.01] appears on the digital display.

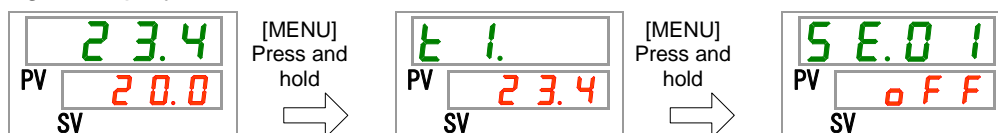

pressure unit Setting and checking

2. Press the [SEL] key 12 times.

The set screen of pressure unit is displayed on the digital display.

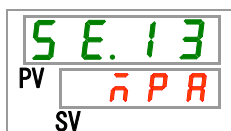

3. Select pressure unit from the table below with [▲] key or [▼] key, and confirm by pressing "SEL".

Table 5.14-2 List of set value

Set value	Explanation	Initial value (Default setting)
MPA	Sets pressure unit is MPa.	○
PSI	Sets pressure unit is PSI.	

4. Press the [MENU] key once.

Return to the main screen (screen displaying the circulating fluid temperature).

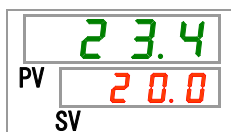

5.15 Alarm buzzer sound setting

5.15.1 Alarm buzzer sound setting

This sets whether a warning sound is made or not when alarm signal is output.

The default setting is buzzer sound ON.

5.15.2 Alarm buzzer sound setting and checking

The table below explains the setting items of the alarm buzzer sound and the initial values.

Table 5.15-1 List of set alarm buzzer sound

Display	Item	Contents	Initial value (Default setting)
	Alarm buzzer sound	Sets alarm buzzer sound.	ON

1. Press and hold the [MENU] key for approx. 2 sec.

Repeat pressing the key until the setting screen for alarm buzzer sound [] appears on the digital display.

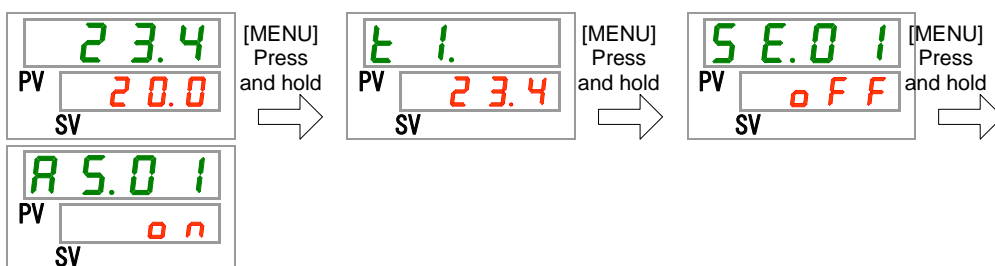

Alarm buzzer sound Setting and checking

2. Select alarm buzzer sound from the table below with [▲] key or [▼] key, and confirm by pressing “SEL”.

Table 5.15-2 List of set value

Set value	Explanation	Initial value (Default setting)
	No alarm buzzer sound	
	Alarm buzzer sound	○

3. Press the [MENU] key once.

Return to the main screen (screen displaying the circulating fluid temperature).

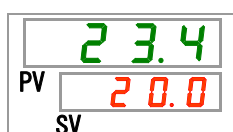

5.16 Alarm customize function

5.16.1 Alarm customize function

The operation and the threshold when alarm signal is output can be customized. Customers should set them depending on their applications.

The alarms below can be customized.

- AL01 Low level in tank (Refer to Table 5.16-3)

Operation: When this alarm signal is output, user can choose to stop/continue the operation.

"Operation stop" is default setting.
- AL03 Circulating fluid discharge temp. rise (Refer to Table 5.16-4 and Table 5.16-5)

Operation: When this alarm signal is output, user can choose to stop/continue operation, or not to detect this alarm.

"Operation continue" is default setting.

Threshold change: Temp. setting at which the alarm is generated can be changed, and also, the alarm generating conditions can be set.

"45.0°C" is default setting.
- AL04 Circulating fluid discharge temp. (Refer to Table 5.16-6 and Table 5.16-7)

Operation: When this alarm signal is output, user can choose to stop/continue operation, or not to detect this alarm.

"Operation continue" is default setting.

Threshold change: Temp. setting at which the alarm is generated can be changed, and also, the alarm generating conditions can be set.

"1.0°C" is default setting.
- AL08 Circulating fluid discharge pressure rise (Refer to Table 5.16-8 and Table 5.16-9)

Operation: When this alarm signal is output, user can choose to stop/continue operation, or not to detect this alarm.

"Operation continue" is default setting.

Threshold change: Pressure at which this alarm is generated can be changed.

"0.30MPa" is default setting.

(High pressure pump [Optional] -T : 「0.50MPa」)
- AL09 Circulating fluid discharge pressure drop (Refer to Table 5.16-10 and Table 5.16-11)

Operation: When this alarm signal is output, user can choose to stop/continue operation, or not to detect this alarm.

"Operation continue" is default setting.

Threshold change: Pressure at which this alarm is generated can be changed.

"0.05MPa" is default setting.

- AL19 Communication error (Refer to Table 5.16-12 and Table 5.16-13)
 Operation: When this alarm signal is output, user can choose to stop/continue operation, or not to detect this alarm.
 "Not to detect" is default setting.
 Threshold change: Time at which this alarm is generated can be changed.
 "30sec" is default setting.
- AL31 Contact input signal 1 detection(Refer toTable 5.16-14)
 Operation: When this alarm signal is output, user can choose to stop/continue operation, or not to detect this alarm.
 "Operation continue" is default setting.
- AL32 Contact input signal 2 detection (Refer to Table 5.16-15)
 Operation: When this alarm signal is output, user can choose to stop/continue operation, or not to detect this alarm.
 "Operation continue" is default setting.
- AL21 DC fuse cut (Refer to Table 5.16-16)
 Operation: When this alarm signal is output, user can choose to stop/continue the operation.
 "Operation stop" is default setting.
- AL33 Water leakage (Refer to Table 5.16-17)
 Operation: When this alarm signal is output, user can choose to stop/continue the operation.
 "Operation stop" is default setting.
- AL34 Electric resistivity/conductivity rise (Refer to Table 5.16-18)
 Operation: When this alarm signal is output, user can choose to continue operation, or not to detect this alarm.
 "Operation continue" is default setting.
 Threshold change: Electric resistivity/conductivity at which this alarm is generated can be changed.
- AL35 Electric resistivity/conductivity drop (Refer to Table 5.16-19)
 Operation: When this alarm signal is output, user can choose to continue operation, or not to detect this alarm.
 "Not to detect" is default setting.
 Threshold change: Electric resistivity/conductivity at which this alarm is generated can be changed.

⚠ CAUTION



"Operation stop" is the default setting for alarm "AL01 Low tank level". If the customer changes this setting to continue operation, fill the circulating fluid immediately after the alarm is generated. Operation without filling the circulating fluid leads to cause malfunction.

5.16.2 Alarm customize function setting and checking

The table below explains the setting items of the alarm customize function and the initial values.

Table 5.16-1 List of set alarm customize function(1/2)

Display	Item	Contents	Initial value (Default setting)
R 5.02	Changing of low tank level	Set the operation when alarm No. AL01 "Low tank level" is generated.	A.STP
R 5.03	Changing of circulating fluid discharge temperature rise	Set the operation when alarm No. AL03 "circulating fluid discharge temperature rise" is generated.	A.RUN
R 5.04	Detection temperature for circulating fluid discharge temperature rise	Sets the detection temperature for the alarm of alarm NO. AL03 "circulating fluid discharge temperature rise". Alarm signal is generated when the temperature becomes higher than this temperature.	45.0 °C (113.0 °F)
R 5.05	Changing of circulating fluid discharge temperature drop	Set the operation when alarm No. AL04 "circulating fluid discharge temperature drop" is generated.	A.RUN
R 5.06	Detection temperature for circulating fluid discharge temperature drop	Sets the detection temperature for the alarm of alarm NO. AL04 "circulating fluid discharge temperature drop". Alarm signal is generated when the temperature becomes lower than this temperature.	1.0 °C (33.8 °F)
R 5.07	Changing of circulating fluid discharge pressure rise	Set the operation when alarm No. AL08 "circulating fluid discharge pressure rise" is generated.	A.RUN
R 5.08	Detection pressure for circulating fluid discharge pressure rise	Sets the detection pressure for the alarm of alarm NO. AL08 "circulating fluid discharge pressure rise". Alarm signal is generated when the pressure becomes higher than this pressure.	0.30MPa (44PSI)
R 5.09	Changing of circulating fluid discharge pressure drop	Set the operation when alarm No. AL09 "circulating fluid discharge pressure drop" is generated.	A.RUN
R 5.10	Detection pressure for circulating fluid discharge pressure drop	Sets the detection pressure for the alarm of alarm NO. AL09 "circulating fluid discharge pressure drop". Alarm signal is generated when the pressure becomes lower than this pressure.	0.05MPa (7PSI)
R 5.11	Changing of operation when communication error	Set the operation when the alarm No. AL19 "Communication error" is generated.	OFF
R 5.12	The monitoring time of communication error	Set the alarm monitoring time when the alarm No. AL19 "Communication error" is generated. Alarm signal is generated when the monitoring time is exceeded.	30 sec
R 5.13	Changing of contact input signal 1 detection	Set the operation when the alarm No. AL31 "contact input signal 1 detection" is generated.	A.STP
R 5.14	Changing of contact input signal 2 detection	Set the operation when the alarm No. AL32 "contact input signal 2 detection" is generated.	A.STP
R 5.15	Changing of DC line fuse cut	Set the operation when the alarm No. AL21 "DC line fuse cut" is generated.	A.STP
R 5.16	Changing of water leakage	Set the operation when the alarm No. AL33 "water leakage" is generated.	A.STP*1
R 5.17	Changing of electric resistivity/conductivity rise	Set the operation when the alarm No. AL34 "Electric resistivity/conductivity rise" is generated.	A.RUN*2
R 5.18	Upper limit of electric resistivity/conductivity rise	Sets the detection level for the alarm of alarm NO. AL34 "Electric resistivity/conductivity rise". Alarm signal is generated when the level becomes higher than this level.	---*2

Table 5.16-2 List of set alarm customize function(2/2)

Display	Item	Contents	Initial value (Default setting)
A5.19	Changing of electric resistivity/conductivity drop	Set the operation when the alarm No. AL35 "Electric resistivity/conductivity drop" is generated.	OFF*2
A5.20	Lower limit of electric resistivity/conductivity drop	Sets the detection level for the alarm of alarm NO. AL35 "Electric resistivity/conductivity drop". Alarm signal is generated when the level becomes lower than this level.	----*2
A5.21	Temperature alarm Monitoring method	One alarm monitoring method can be selected from four methods for AL04 "Detection temp for the circulating fluid discharge temp. increase" and AL06 "Detection temp. for circulating fluid discharge temp. drop".	0
A5.22	Monitoring start timer	Alarm will not be generated during the set period of time after starting operation. Alarm monitoring starts when it reaches the set time.	----
A5.23	Range over Detection timer	After starting the alarm monitoring, the alarm will not be generated right away and will be kept not generated for the set period of time for AL04 "Detection temp for the circulating fluid discharge temp. increase" and AL06 "Detection temp. for circulating fluid discharge temp. drop", when the temperatures goes out of the set range.	5

*1: This function is available for customers who have purchased the drain pan set (part no.: HRS-WL002).

*2: This function is available for customers who have purchased the electric resistivity/conductivity sensor set.

1. Press and hold the [MENU] key for approx. 2 sec.

Repeat pressing the key until the setting screen for alarm buzzer sound [**A5.01**] appears on the digital display.

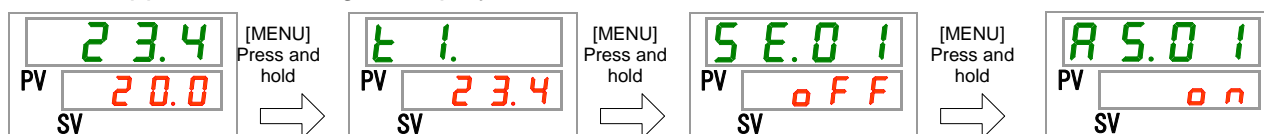

Low tank level Setting and checking

2. Press the [SEL] key once.

The set screen of changing of low tank level is displayed on the digital display.



3. Select changing of low tank level from the table below with [▲] key or [▼] key, and confirm by pressing "SEL".

Table 5.16-3 List of set value

Set value	Explanation	Initial value (Default setting)
A.r.U.n	Operation continues when this alarm signal is generated.	
A.5.L.P	Operation is stopped when this alarm signal is generated.	○

Changing of circulating fluid discharge temperature rise Setting and checking

4. Press the [SEL] key once.

The set screen of changing of circulating fluid discharge temperature rise is displayed on the digital display.

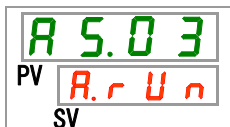

5. Select changing of circulating fluid discharge temperature rise from the table below with [▲] key or [▼] key, and confirm by pressing “SEL”.

Table 5.16-4 List of set value

Set value	Explanation	Initial value (Default setting)
	This alarm signal is not detected.	
	Operation continues when this alarm signal is generated.	○
	Operation is stopped when this alarm signal is generated.	

Detection temperature for circulating fluid discharge temperature rise Setting and checking

6. Press the [SEL] key once.

The set screen of detection temperature for circulating fluid discharge temperature rise is displayed on the digital display.



7. Select detection temperature for circulating fluid discharge temperature rise from the table below with [▲] key or [▼] key, and confirm by pressing “SEL”.

Table 5.16-5 List of set value

Set value	Explanation	Initial value (Default setting)
	Setting/checking are not available if the setting of the circulating fluid discharge temperature rise is OFF.	
Centigrade to 	Sets detection temp for the circulating fluid discharge temperature rise.	
Fahrenheit to 	Temperature unit is Centigrade : Setting unit is 0.1°C Temperature unit is Fahrenheit : Setting unit is 0.1°F	

Changing of circulating fluid discharge temperature drop setting and checking

8. Press the [SEL] key once.

The set screen of changing of circulating fluid discharge temperature drop is displayed on the digital display.



9. Select changing of circulating fluid discharge temperature drop from the table below with [▲] key or [▼] key, and confirm by pressing "SEL".

Table 5.16-6 List of set value

Set value	Explanation	Initial value (Default setting)
<input type="text" value="o F F"/>	This alarm signal is not detected.	
<input type="text" value="R.r U n"/>	Operation continues when this alarm signal is generated.	○
<input type="text" value="R.5 t P"/>	Operation is stopped when this alarm signal is generated.	

Detection temperature for circulating fluid discharge temperature drop Setting and checking

10. Press the [SEL] key once.

The set screen of detection temperature for circulating fluid discharge temperature drop is displayed on the digital display.



11. Select detection temperature for circulating fluid discharge temperature drop from the table below with [▲] key or [▼] key, and confirm by pressing "SEL".

Table 5.16-7 List of set value

Set value	Explanation	Initial value (Default setting)
<input type="text" value="- - - -"/>	Setting/checking are not available if the setting of the circulating fluid discharge temperature drop is OFF.	
Centigrade <input type="text" value="1.0"/> to <input type="text" value="39.0"/>	Sets detection temp for the circulating fluid discharge temperature drop.	<input type="text" value="1.0"/>
Fahrenheit <input type="text" value="33.8"/> to <input type="text" value="102.2"/>	Temperature unit is Fahrenheit : Setting unit is 0.1°F	<input type="text" value="33.8"/>

Changing of circulating fluid discharge pressure rise Setting and checking

12. Press the [SEL] key once.

The set screen of changing of circulating fluid discharge pressure rise is displayed on the digital display.

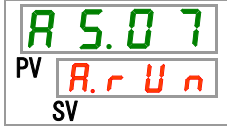

13. Select changing of circulating fluid discharge pressure rise from the table below with [▲] key or [▼] key, and confirm by pressing “SEL”.

Table 5.16-8 List of set value

Set value	Explanation	Initial value (Default setting)
	This alarm signal is not detected.	
	Operation continues when this alarm signal is generated.	○
	Operation is stopped when this alarm signal is generated.	

Detection temperature for circulating fluid discharge pressure rise Setting and checking

14. Press the [SEL] key once.

The set screen of detection temperature for circulating fluid discharge pressure rise is displayed on the digital display.

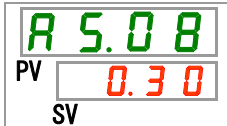

15. Select detection temperature for circulating fluid discharge pressure rise from the table below with [▲] key or [▼] key, and confirm by pressing “SEL”.

Table 5.16-9 List of set value

Set value	Explanation	Initial value (Default setting)
	Setting/checking are not available if the setting of the circulating fluid discharge pressure rise is OFF.	
MPa to 	Sets detection temp for the circulating fluid discharge pressure rise. •Option -T Set range: 0.05 to 0.50MPa (7 to 73PSI) Default setting: 0.50MPa (73PSI)	
PSI to 		

Changing of circulating fluid discharge pressure drop Setting and checking

16. Press the [SEL] key once.

The set screen of changing of circulating fluid discharge pressure drop is displayed on the digital display.

**17.** Select changing of circulating fluid discharge pressure dro from the table below with [▲] key or [▼] key, and confirm by pressing "SEL".

Table 5.16-10 List of set value

Set value	Explanation	Initial value (Default setting)
<input type="text" value="o F F"/>	This alarm signal is not detected.	
<input type="text" value="R.r U n"/>	Operation continues when this alarm signal is generated.	○
<input type="text" value="R.5 t P"/>	Operation is stopped when this alarm signal is generated.	

Detection temperature for circulating fluid discharge pressure drop Setting and checking

18. Press the [SEL] key once.

The set screen of detection temperature for circulating fluid discharge pressure drop is displayed on the digital display.

**19.** Select detection temperature for circulating fluid discharge pressure drop from the table below with [▲] key or [▼] key, and confirm by pressing "SEL".

Table 5.16-11 List of set value

Set value	Explanation	Initial value (Default setting)
<input type="text" value="- - - -"/>	Setting/checking are not available if the setting of the circulating fluid discharge temperature drop is OFF.	
<input type="text" value="MPa 0.05"/>	Sets detection temperature for circulating fluid discharge pressure drop.	<input type="text" value="0.05"/>
to <input type="text" value="0.50"/>		
<input type="text" value="PSI 7"/>	Pressure unit is MPa : Setting unit is 0.01MPa Pressure unit is PSI : Setting unit is 1PSI	<input type="text" value="7"/>
to <input type="text" value="73"/>		

Changing of operation when communication error Setting and checking

20. Press the [SEL] key once.

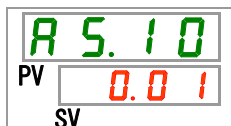
The set screen of changing of operation when communication error is displayed on the digital display.

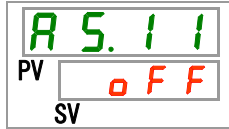

21. Select changing of operation when communication error from the table below with [▲] key or [▼] key, and confirm by pressing “SEL”.

Table 5.16-12 List of set value

Set value	Explanation	Initial value (Default setting)
OFF	This alarm signal is not detected.	○
Run	Operation continues when this alarm signal is generated.	
Stop	Operation is stopped when this alarm signal is generated.	

The monitoring time of communication error Setting and checking

22. Press the [SEL] key once.

The set screen of the monitoring time of communication error is displayed on the digital display.

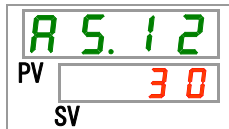

23. Select the monitoring time of communication error from the table below with [▲] key or [▼] key, and confirm by pressing “SEL”.

Table 5.16-13 List of set value

Set value	Explanation	Initial value (Default setting)
---	Setting/checking are not available if the setting of the communication error is OFF.	
30 to 600	Sets communication error. Set unit is 1 sec. unit.	30

Changing of Contact input signal 1 detection Setting and checking

24. Press the [SEL] key once.

The set screen of the changing of contact input signal 1 detection is displayed on the digital display.



- 25.** Select the changing of contact input signal 1 detection from the table below with [▲] key or [▼] key, and confirm by pressing “SEL”.

Table 5.16-14 List of set value

Set value	Explanation	Initial value (Default setting)
OFF	This alarm signal is not detected.	
R.rUn	Operation continues when this alarm signal is generated.	
R.S.tP	Operation is stopped when this alarm signal is generated.	○

Changing of Contact input signal 2 detection Setting and checking

- 26.** Press the [SEL] key once.

The set screen of the changing of contact input signal 2 detection is displayed on the digital display.



- 27.** Select the changing of contact input signal 2 detection from the table below with [▲] key or [▼] key, and confirm by pressing “SEL”.

Table 5.16-15 List of set value

Set value	Explanation	Initial value (Default setting)
OFF	This alarm signal is not detected.	
R.rUn	Operation continues when this alarm signal is generated.	
R.S.tP	Operation is stopped when this alarm signal is generated.	○

Changing of DC line fuse cut Setting and checking

- 28.** Press the [SEL] key once.

The set screen of the changing of DC line fuse cut is displayed on the digital display.



29.Select the changing of DC line fuse cut from the table below with [▲] key or [▼] key, and confirm by pressing “SEL”.

Table 5.16-16 List of set value

Set value	Explanation	Initial value (Default setting)
R.r U n	Operation continues when this alarm signal is generated.	
R.5 t P	Operation is stopped when this alarm signal is generated.	○

Changing of water leakage Setting and checking

30.Press the [SEL] key once.

The set screen of the changing of water leakage is displayed on the digital display.



31.Select the changing of water leakage from the table below with [▲] key or [▼] key, and confirm by pressing “SEL”.

Table 5.16-17 List of set value

Set value	Explanation	Initial value (Default setting)
- - - -	Setting/checking are not available if the setting of the water leakage option is OFF.	
R.r U n	Operation continues when this alarm signal is generated.	
R.5 t P	Operation is stopped when this alarm signal is generated.	○

Changing of electric resistivity/conductivity rise Setting and checking

32.Press the [SEL] key once.

The set screen of the changing of electric resistivity/conductivity rise is displayed on the digital display.

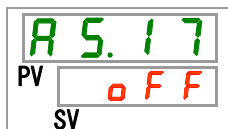

- 33.** Select the changing of electric resistivity/conductivity rise from the table below with [▲] key or [▼] key, and confirm by pressing “SEL”.

Table 5.16-18 List of set value

Set value	Explanation	Initial value (Default setting)
----	Setting/checking are not available if the setting of the electric resistivity/conductivity option is OFF.	
OFF	This alarm signal is not detected.	
R.r U n	Operation continues when this alarm signal is generated.	○

Changing of upper limit of electric resistivity/conductivity rise Setting and checking

- 34.** Press the [SEL] key once.

The set screen of the changing of upper limit of electric resistivity/conductivity rise is displayed on the digital display.



- 35.** Select the changing of upper limit of electric resistivity/conductivity rise with [▲] key or [▼] key, and confirm by pressing “SEL”. Refer to the Operation Manual attached to these optional accessories for details.

Changing of electric resistivity/conductivity drop Setting and checking

- 36.** Press the [SEL] key once.

The set screen of the changing of electric resistivity/conductivity drop is displayed on the digital display.

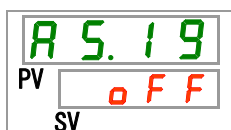

- 37.** Select the changing of electric resistivity/conductivity drop from the table below with [▲] key or [▼] key, and confirm by pressing “SEL”.

Table 5.16-19 List of set value

Set value	Explanation	Initial value (Default setting)
----	Setting/checking are not available if the setting of the electric resistivity/conductivity option is OFF.	
OFF	This alarm signal is not detected.	○
R.r U n	Operation continues when this alarm signal is generated.	

Changing of lower limit of electric resistivity/conductivity drop Setting and checking

38. Press the [SEL] key once.

The set screen of the changing of lower limit of electric resistivity/conductivity drop is displayed on the digital display.

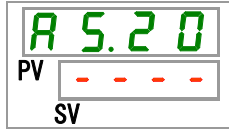

39. Select the changing of lower limit of electric resistivity/conductivity drop with [▲] key or [▼] key, and confirm by pressing "SEL". Refer to the Operation Manual attached to these optional accessories for details.

How to monitor the temperature alarm Setting and Checking

40. Press the [SEL] key once.

Setting screen of the temperature alarm monitoring method is displayed on the digital display.

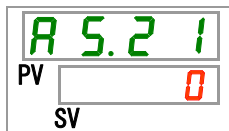

41. Select temperature alarm monitoring method from the table below with [▲] key or [▼] key, and confirm by pressing "SEL".

Table 5.16-20 List of set value

Set value	Item	Explanation	Initial value (Default setting)
<input type="text" value="0"/>	Continuous monitoring	Alarm monitoring starts at the same time as operation starts.	○
<input type="text" value="1"/>	Automatic monitoring	When the circulating fluid temperature is outside of the alarm threshold range at the time of operation start, the alarm will not be generated until the temperature comes inside the alarm threshold range.	
<input type="text" value="2"/>	Monitoring start timer	Alarm will not be generated until it reaches the time set for the AS.22 "Monitoring start timer" after the operation starts. Alarm monitoring starts when it reaches the set time.	
<input type="text" value="3"/>	Automatic monitoring + Monitoring start timer	Alarm will not be generated until it reaches the time set for the AS.22 "Monitoring start timer" after the operation starts. Alarm monitoring starts when it reaches the set time. When the circulating fluid temperature enters the alarm threshold range before it reaches the set time, the alarm monitoring will be started at that time.	

* Settings of this function and example of alarm generating timing for 5.15.3 "Setting of temperature alarm monitoring method and generation timing".

Monitoring start timer Setting and Checking

42. Press the [SEL] key once.

Setting screen of the monitoring start timer is displayed on the digital display.

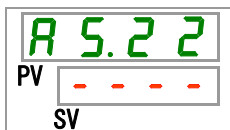

43. Select monitoring start timer from the table below with [▲] key or [▼] key, and confirm by pressing "SEL".

Table 5.16-21 List of set value

Set value	Explanation	Initial value (Default setting)
----	Setting and checking are impossible when "0: Continuous monitoring" or "1: Automatic monitoring" is selected for the setting of AS21 "Temperature alarm monitoring method".	○
0 to 600	Sets the time when alarm monitoring starts Setting unit is 1 minute.	

* Settings of this function and example of alarm generating timing for 5.15.3 "Setting of temperature alarm monitoring method and generation timing".

Range over detection timer; Setting and Checking

44. Press the [SEL] key once.

Setting screen of the range over detection timer is displayed on the digital display.



45. Select range over detection timer from the table below with [▲] key or [▼] key, and confirm by pressing "SEL".

Table 5.16-22 List of set value

Set value	Explanation	Initial value (Default setting)
5 to 999	Sets time from detecting the alarm to generation of the alarm. Setting unit is 1 second.	5

* Settings of this function and example of alarm generating timing for 5.15.3 "Setting of temperature alarm monitoring method and generation timing".

46. Press the [MENU] key once.

Return to the main screen (screen displaying the circulating fluid temperature).

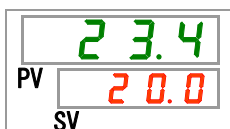

5.16.3 Setting of temperature alarm monitoring method and alarm generation timing

Examples of temperature alarm monitoring method setting and alarm generation timing are shown below.

■ When "**Automatic monitoring**" is selected

- [1] Circulating fluid temperature when starting operation: Approximately 20 °C
- [2] Circulating fluid set temperature: 15 °C
- [3] "AS.21: Temperature alarm monitoring method": Select "Automatic monitoring".
 ("----" (invalid setting) will be shown for "AS.22: Monitoring start timer".)
- [4] "AS.04: Detection temp. for the circulating fluid discharge temp. increase": Set to "16 °C".
- [5] "AS.06: Detection temp. for the circulating fluid discharge temp. drop": Set to "14 °C".
- [6] "AS.23: Range over detection timer "Set to "600 sec".

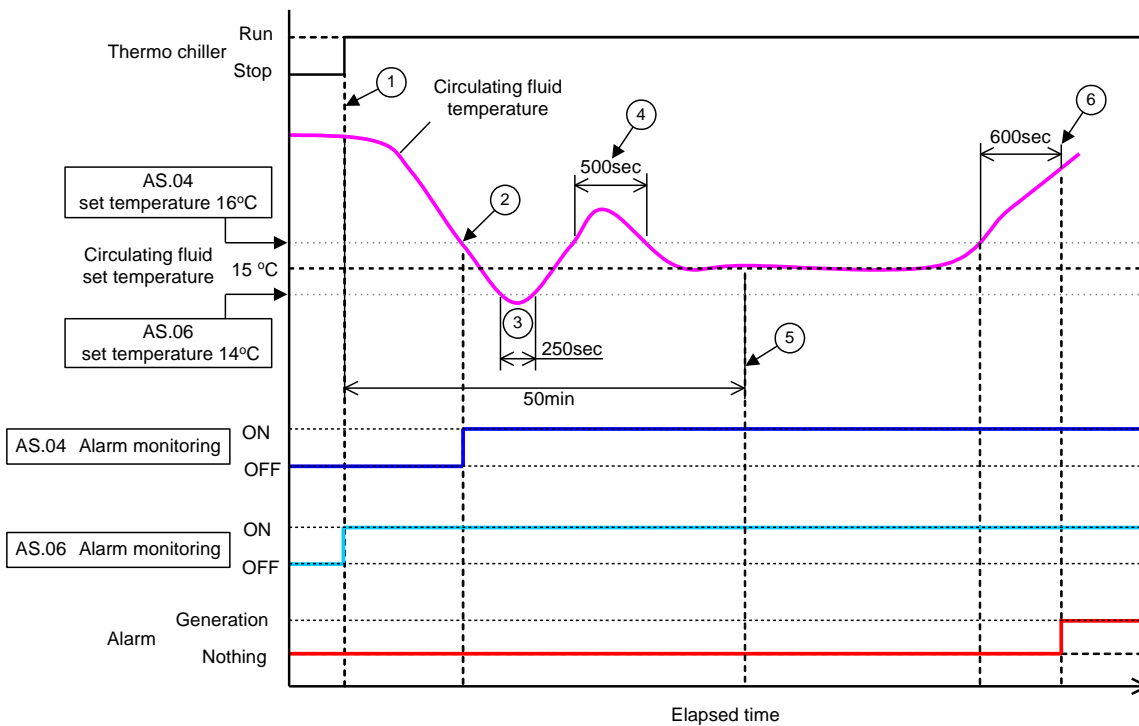

Fig 5.16-1 Alarm generation timing

■ -Alarm generation timing

- Status (1): Temperature alarm monitoring starts by starting the chiller operation. As the circulating fluid temperature at this time is 20 °C, "AS.06" starts alarm monitoring at the same time as the operation start.
- Status (2): The circulating fluid temperature becomes within the set range of "AS.04", and starts "AS.04" alarm monitoring".
- Status (3): The circulating fluid temperature exceeds the threshold of "AS.06", but the alarm will not be generated as it has returned within the 600 sec range of the "AS.23: Range over detecting timer".
- Status (4): The circulating fluid temperature exceeds the threshold of "AS.04", but the alarm will not be generated as it has returned within the 600 sec range of the "AS.23: Range over detecting timer".
- Status (5): Alarm "AL03: Circulating fluid discharge temp. increase" will be generated after 600 seconds that is set for the "AS.23: Range over detection timer" after the circulating fluid temperature exceeds the threshold of "AS.04".

■ When "Automatic monitoring + Monitoring start timer" is selected

- [1] Circulating fluid temperature when starting operation: Approximately 20 °C
- [2] Circulating fluid set temperature: 15 °C
- [3] "AS.21: Temperature alarm monitoring method": Select "Automatic monitoring + Monitoring start timer".
- [4] "AS.22: Monitoring start timer": Set it to "50 min".
- [5] "AS.04: Detection temp. for the circulating fluid discharge temp. increase": Set to "16 °C".
- [6] "AS.06: Detection temp. for the circulating fluid discharge temp. drop": Set to "14 °C".
- [7] "AS.23: Range over detection timer": Set to "600 sec".

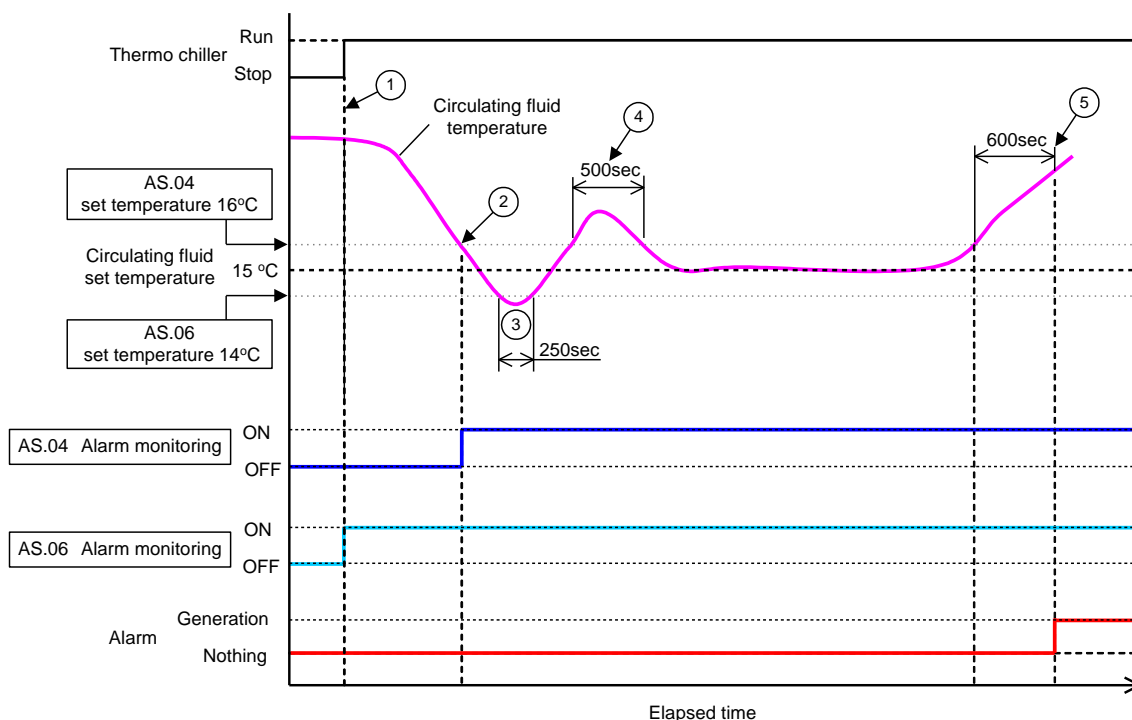

5.16-2 Alarm generation timing

Fig

■ -Alarm generation timing

- Status (1): Start operation of the chiller. As the circulating fluid temperature is within the set range of "AS.06", "AS.06" alarm monitoring starts.
- Status (2): The circulating fluid temperature becomes within the set range of "AS.04". "AS.04" alarm monitoring starts.
- Status (3): The circulating fluid temperature exceeds the threshold of "AS.06", but the alarm will not be generated as it has returned within the 600 sec range of the "AS.23: Range over detecting timer".
- Status (4): The circulating fluid temperature exceeds the threshold of "AS.04", but the alarm will not be generated as it has returned within the 600 sec range of the "AS.23: Range over detecting timer".
- Status (5): 50 minutes passes after starting operation. Alarm monitoring has started. It shows that the "50 min" setting does not influence the alarm monitoring under these conditions.
- Status (6): Alarm will be generated after 600 seconds that is set for "AS.23: Range over detection timer" after the circulating fluid temperature exceeds the threshold of "AS.04".

5.17 Data reset function

5.17.1 Data reset function

Values set by customer are reset to default values. Accumulated operating time is not reset.

⚠ CAUTION



All setting values are reset.
 It is recommended to record set data before reset.

5.17.2 Method of resetting data reset function

The table below explains the setting items of the data reset and the initial values.

Table 5.17-1 List of data reset

Display	Item	Contents	Initial value (Default setting)
SE.14	Data reset	All data is reset. (Accumulated operation time is not reset.)	NO

1. Press and hold the [MENU] key for approx. 2 sec.

Repeat pressing the key until the setting screen for key-lock [SE.01] appears on the digital display.

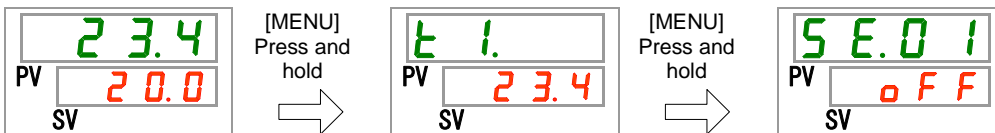

Data reset

2. Press the [SEL] key 13 times.

The set screen of data reset is displayed on the digital display.

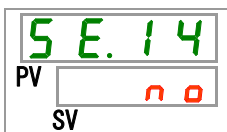

3. Select YES from the table below with [▲] key or [▼] key, and confirm by pressing "SEL". Select YES, then all data returns to default setting. The display returns to the main screen.

Table 5.17-2 List of set value

Set value	Explanation	Initial value (Default setting)
no	Not reset	○
YES	All data is reset	

5.18 Accumulated time reset function

5.18.1 Accumulated time reset function

The alarms below are generated to notify the maintenance time.
The product is not stopped for alarm.

- Pump maintenance (AL28): Generated after 20,000h of accumulated operating time
- Fan motor maintenance (AL29) : Generated after 20,000h of accumulated operating time.
*For air-cooled type
- Compressor maintenance (AL30): Generated after 50,000h of accumulated operating time

To reset the alarm, reset the accumulated operating time.
Reset the accumulated time after the replacement of parts (call for inspection service).

5.18.2 Method of resetting accumulated time reset function

The table below explains the setting items of the accumulated time reset and the initial values.

Table 5.18-1 List of set accumulated time reset function

Display	Item	Contents	Initial value (Default setting)
SE.15	Pump accumulated operating time reset	Reset the accumulated operating time of the pump.	NO
SE.16	Fan motor accumulated operating time reset	Reset the accumulated operating time of the fan motor. (For air-cooled type)	NO
SE.17	Compressor accumulated operating time reset	Reset the accumulated operating time of the compressor.	NO

Refer to each paragraph for the detail of resetting the accumulated operating time.

1. Press and hold the [MENU] key for approx. 2 sec.

Repeat pressing the key until the setting screen for key-lock [SE.01] appears on the digital display.

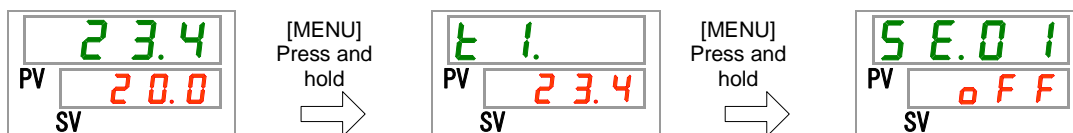

Pump accumulated operating time reset

2. Press the [SEL] key 14 times.

The set screen of pump accumulated operating time reset is displayed on the digital display.

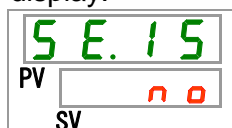

3. Select from the table below with [▲] key or [▼] key, and confirm by pressing "SEL". Select , then the accumulated operating time of the pump is reset. The display returns to the main menu.

Table 5.18-2 List of set value

Set value	Explanation	Initial value (Default setting)
<input type="text" value="no"/>	Not reset	○
<input type="text" value="YES"/>	Pump accumulated operating time is reset	

Fun motor accumulated operating time reset

4. Press the [SEL] key once.

The set screen of fun motor accumulated operating time reset is displayed on the digital display.



5. Select from the table below with [▲] key or [▼] key, and confirm by pressing "SEL". Select , then the accumulated operating time of the fan motor is reset. The display returns to the main menu.

Table 5.18-3 List of set value

Set value	Explanation	Initial value (Default setting)
<input type="text" value="----"/>	Not possible to reset	
<input type="text" value="no"/>	Not reset	○
<input type="text" value="YES"/>	Fan motor accumulated operating time is reset	

Compressor accumulated operating time reset

6. Press the [SEL] key once.

The set screen of compressor accumulated operating time reset is displayed on the digital display.

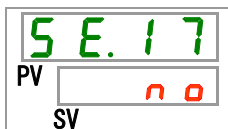

7. Select from the table below with [▲] key or [▼] key, and confirm by pressing "SEL". Select , then the accumulated operating time of the compressor is reset. The display returns to the main menu.

Table 5.18-4 List of set value

Set value	Explanation	Initial value (Default setting)
<input type="text" value="no"/>	Not reset	○
<input type="text" value="YES"/>	Compressor accumulated operating time is reset	

5.19 Communication function

5.19.1 Communication function

The product can have contact input/output and serial communication.
Refer to the Operation Manual for communication for details.

5.19.2 Communication function setting and checking

The table below explains the setting items of the communication function and the initial values.

Table 5.19-1 List of set communication function

Display	Item	Contents	Initial value (Default setting)	
[Co.01]	Communication mode	Sets communication mode.	LOC	
[Co.02]	Serial protocol	Sets serial communication protocol.	MDBS	
[Co.03]	Communication specification	Sets standard of the serial communication.	485	
[Co.04]	RS-485 terminal	Sets of the terminal of RS-485.	OFF	
[Co.05]	Serial communication bus Mod	Slave address	Sets slave address.	1
[Co.06]		Communication speed	Sets communication speed.	19.2
[Co.07]	Serial communication protocol Simple	Slave address	Sets slave address.	1
[Co.08]		Communication speed	Sets communication speed.	9.6
[Co.09]		BCC	Sets error detection code.	ON
[Co.10]		Data length	Sets data length.	8BIT
[Co.11]		Parity check	Sets parity check.	NON
[Co.12]		Stop bit length	Sets stop bit length	2BIT
[Co.13]		Response delay time	Sets time to delay the response message.	0
[Co.14]		Communication range	Sets communication range.	RW
[Co.15]	Contact input/output communication	Contact input signal 1	Sets contact input signal 1.	RUN
[Co.16]		Contact input signal 1 type	Sets input type of contact input signal 1.	ALT
[Co.17]		Contact input signal 1 Delay timer (time delay) of reading	Sets the delay timer of reading of contact input signal 1.	0
[Co.18]		Contact input signal 1 OFF detection timer	Sets the contact input signal 1 OFF detection timer	0
[Co.19]		Contact input signal 2	Sets contact input signal 2.	OFF
[Co.20]		Contact input signal 2 type	Sets input type of contact input signal 2.	ALT
[Co.21]		Contact input signal 2 Delay timer (time delay) of reading	Sets the delay timer of reading of contact input signal 2.	0
[Co.22]		Contact input signal 2 OFF detection timer	Sets the contact input signal 2 OFF detection timer	0
[Co.23]		Contact output 1 function	Sets contact output signal 1.	RUN
[Co.24]		Contact output 1 operation	Sets input type of contact output signal 1.	A
[Co.25]		Contact output 1 selected alarm	Sets alarm which is selected for contact output 1.	AL.01
[Co.26]		Contact output 2 function	Sets output signal function of contact output 2.	RMT
[Co.27]		Contact output 2 operation	Sets output signal operation of contact output 2.	A
[Co.28]		Contact output 2 selected alarm	Sets alarm which is selected for contact output 2.	AL.01
[Co.29]		Contact output 3 function	Sets output signal function of contact output 3.	ALM
[Co.30]	Contact output 3 operation	Sets output signal operation of contact output 3.	B	
[Co.31]	Contact output 3 selected alarm	Sets alarm which is selected for contact output 3.	AL.01	

Communication mode setting and checking

1. Press and hold the [MENU] key for approx. 2 sec.

Repeat pressing the key until the setting screen for communication mode [Co.01] appears on the digital display.

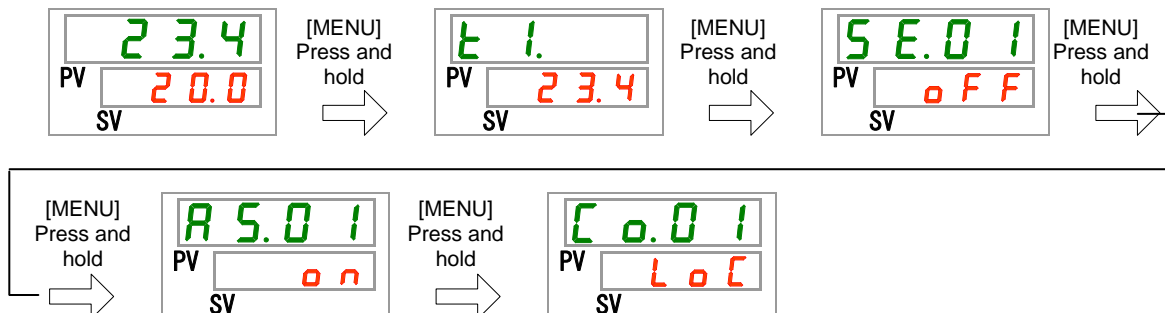

2. Select communication mode from the table below with [▲] key or [▼] key, and confirm by pressing “SEL”.

Table 5.19-2 List of set value

Set value	Explanation	Initial value (Default setting)
LoC	Sets LOCAL mode. (The operation panel operates and sets the thermo-chiller.)	○
dIo	Sets DIO mode.*1 (The operation starts with contact input/output.)	
SEr	Sets SERIAL mode.*2 (Serial communication performs operation/setting.)	

*1: When the setting of the contact input 1 is “External switch signal”, “DIO mode” cannot be set.
 *2: If the serial protocol is “Simple communication protocol 2” and the contact input 1 is “external switch signal” or contact input 2 is “remote signal”, “SERIAL mode” cannot be set.

Serial protocol Setting and checking

3. Press the [SEL] key once.

The set screen of serial protocol is displayed on the digital display.

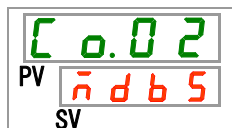

4. Select serial protocol from the table below with [▲] key or [▼] key, and confirm by pressing “SEL”.

Table 5.19-3 List of set value

Set value	Explanation	Initial value (Default setting)
Modbus	MODBUS protocol	○
Pro1	Simple communication protocol 1	
Pro2	Simple communication protocol 2*3	

*3: When the setting of the contact input 2 is “Remote signal”, “Simplified communication protocol 2” cannot be set.

Communication specification Setting and checking

5. Press the [SEL] key once.

The set screen of communication specification is displayed on the digital display.

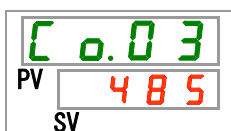

6. Select communication specification from the table below with [▲] key or [▼] key, and confirm by pressing “SEL”.

Table 5.19-4 List of set value

Set value	Explanation	Initial value (Default setting)
232C	RS-232C	
485	RS-485	○

RS-485 terminal Setting and checking

7. Press the [SEL] key once.

The set screen of RS-485 terminal is displayed on the digital display.

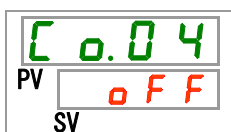

8. Select RS-485 terminal from the table below with [▲] key or [▼] key, and confirm by pressing “SEL”.

Table 5.19-5 List of set value

Set value	Explanation	Initial value (Default setting)
OFF	No terminal	○
ON	With terminal	

Slave addresses (MODBUS) Setting and checking

9. Press the [SEL] key once.

The set screen of slave addresses (MODBUS) is displayed on the digital display.

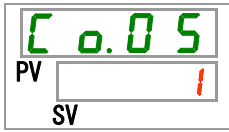

10. Select slave addresses (MODBUS) from the table below with [▲] key or [▼] key, and confirm by pressing “SEL”.

Table 5.19-6 List of set value

Set value	Explanation	Initial value (Default setting)
---	Setting/checking are not available unless the serial protocol setting is MODBUS.	
1 to 99	Sets of slave addresses for MODBUS. Set range is 1 to 99.	1

Communication speed (MODBUS) Setting and checking

11. Press the [SEL] key once.

The set screen of communication speed (MODBUS) is displayed on the digital display.

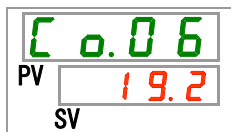

12. Select communication speed (MODBUS) from the table below with [▲] key or [▼] key, and confirm by pressing “SEL”.

Table 5.19-7 List of set value

Set value	Explanation	Initial value (Default setting)
---	Setting/checking are not available unless the serial protocol setting is MODBUS.	
9.6	9600bps	
19.2	19200bps	○

Slave addresses (simple communication protocol) Setting and checking

13. Press the [SEL] key once.

The set screen of slave addresses (simple communication protocol) is displayed on the digital display.



14.Select slave addresses (simple communication protocol) from the table below with [▲] key or [▼] key, and confirm by pressing “SEL”.

Table 5.19-8 List of set value

Set value	Explanation	Initial value (Default setting)
----	Setting/checking are not available unless the serial protocol setting is simple communication protocol.	
1 to 99	Sets of slave addresses for simple communication protocol. Set range is 1 to 99.	1

Communication speed (simple communication protocol) Setting/checking

15.Press the [SEL] key once.

The set screen of communication speed (simple communication protocol) is displayed on the digital display.



16.Select communication speed (simple communication protocol) from the table below with [▲] key or [▼] key, and confirm by pressing “SEL”.

Table 5.19-9 List of set value

Set value	Explanation	Initial value (Default setting)
----	Setting/checking are not available unless the serial protocol setting is simple communication protocol.	
1.2	1200bps	
2.4	2400bps	
4.8	4800bps	
9.6	9600bps	○
19.2	19200bps	

BCC (simple communication protocol) Setting/checking

17.Press the [SEL] key once.

The set screen of BCC (simple communication protocol) is displayed on the digital display.



18.Select BCC (simple communication protocol) from the table below with [▲] key or [▼] key, and confirm by pressing “SEL”.

Table 5.19-10 List of set value

Set value	Explanation	Initial value (Default setting)
----	Setting/checking are not available unless the serial protocol setting is simple communication protocol.	
oFF	No BCC	
oN	With BCC	○

Data length (simple communication protocol) Setting and checking

19.Press the [SEL] key once.

The set screen of data length (simple communication protocol) is displayed on the digital display.



20.Select data length (simple communication protocol) from the table below with [▲] key or [▼] key, and confirm by pressing “SEL”.

Table 5.19-11 List of set value

Set value	Explanation	Initial value (Default setting)
----	Setting/checking are not available unless the serial protocol setting is simple communication protocol.	
7bit	7 bit	
8bit	8 bit	○

Parity check (simple communication protocol) Setting and checking

21.Press the [SEL] key once.

The set screen of parity check (simple communication protocol) is displayed on the digital display.



22. Select parity check (simple communication protocol) from the table below with [▲] key or [▼] key, and confirm by pressing “SEL”.

Table 5.19-12 List of set value

Set value	Explanation	Initial value (Default setting)
----	Setting/checking are not available unless the serial protocol setting is simple communication protocol.	
non	None	○
odd	Odd number	
Even	Even number	

Stop bit (simple communication protocol) Setting and checking

23. Press the [SEL] key once.

The set screen of stop bit (simple communication protocol) is displayed on the digital display.



24. Select stop bit (simple communication protocol) from the table below with [▲] key or [▼] key, and confirm by pressing “SEL”.

Table 5.19-13 List of set value

Set value	Explanation	Initial value (Default setting)
----	Setting/checking are not available unless the serial protocol setting is simple communication protocol.	
1bit	1 bit	
2bit	2 bit	○

Response delay time (simple communication protocol) Setting and checking

25. Press the [SEL] key once.

The set screen of response delay time (simple communication protocol) is displayed on the digital display.

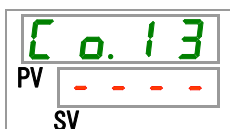

26.Select response delay time (simple communication protocol) from the table below with [▲] key or [▼] key, and confirm by pressing “SEL”.

Table 5.19-14 List of set value

Set value	Explanation	Initial value (Default setting)
----	Setting/checking are not available unless the serial protocol setting is simple communication protocol.	
0 to 250	Setting of response delay time. Set range is 0 to 250msec.	0

Communication range (simple communication protocol) Setting and checking

27.Press the [SEL] key once.

The set screen of communication range (simple communication protocol) is displayed on the digital display.



28.Select communication range (simple communication protocol) from the table below with [▲] key or [▼] key, and confirm by pressing “SEL”.

Table 5.19-15 List of set value

Set value	Explanation	Initial value (Default setting)
----	Setting/checking are not available unless the serial protocol setting is simple communication protocol.	
ro	Only reading is available	
rw	Reading and writing are available	○

Contact input signal 1 Setting and checking

29.Press the [SEL] key once.

The set screen of contact input signal 1 is displayed on the digital display.

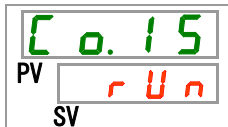

30. Select contact input signal 1 from the table below with [▲] key or [▼] key, and confirm by pressing “SEL”.

Table 5.19-16 List of set value

Set value	Explanation	Initial value (Default setting)
o F F	No input signal	
r U n	Start and stop signal input	○
S H _ A	External switch signal input(N.O. type) ^{*4,*5}	
S H _ b	External switch signal input (N.C. type) ^{*4,*5}	

*4: When the setting of the communication mode is “DIO mode”, “External switch signal” cannot be set.

*5: When the setting of the communication mode is “SEIRAL mode” and the protocol setting is “Simplified communication protocol 2”, “External switch signal” cannot be set.

Contact input signal 1 type Setting and checking

31. Press the [SEL] key once.

The set screen of contact input signal 1 type is displayed on the digital display.



32. Select contact input signal 1 type from the table below with [▲] key or [▼] key, and confirm by pressing “SEL”.

Table 5.19-17 List of set value

Set value	Explanation	Initial value (Default setting)
- - - -	Setting/checking are not available if the setting of contact input signal 1 is OFF.	
ALt	Alternate signal	○
n̄t	Momentary signal ^{*6}	

*6: Used when the setting of the contact input 1 is “Operation stop signal input”.

Contact input signal 1 delay timer of reading Setting and checking

33. Press the [SEL] key once.

The set screen of the contact input signal 1 delay timer of reading is displayed on the digital display.



34.Select contact input signal 1 delay timer of reading from the table below with [▲] key or [▼] key, and confirm by pressing “SEL”.

Table 5.19-18 List of set value

Set value	Explanation	Initial value (Default setting)
----	Setting and checking are not available unless contact input signal 1 is external switch signal input (N.O. type or N.C. type).	
0 to 300	Setting of contact input signal 1 delay timer of reading. Set range is 0 to 300 sec.	0

Contact input signal 1 OFF detection timer Setting and checking

35.Press the [SEL] key once.

The set screen of the contact input signal 1 OFF detection timer is displayed on the digital display.

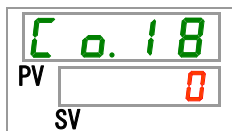

36.Select contact input signal 1 OFF detection timer from the table below with [▲] key or [▼] key, and confirm by pressing “SEL”.

Table 5.19-19 List of set value

Set value	Explanation	Initial value (Default setting)
----	Setting and checking are not available unless contact input signal 1 is external switch signal input (N.O. type or N.C. type).	
0 to 10	Setting of contact input signal 1 OFF detection timer Set range is 0 to 10sec.	0

Contact input signal 2 Setting and checking

37.Press the [SEL] key once.

The set screen of contact input signal 2 is displayed on the digital display.

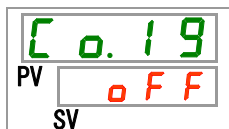

38.Select contact input signal 2 from the table below with [▲] key or [▼] key, and confirm by pressing “SEL”.

Table 5.19-20 List of set value

Set value	Explanation	Initial value (Default setting)
OFF	Without input signal	○
run	Input of run/stop signal	
SH-A	External switch signal input(N.O. type)	
SH-b	External switch signal input (N.C. type)	
remote	Remote signal*7	

*7:When the setting of the serial protocol is “Simplified communication protocol 2”, “Remote signal” cannot be set.

Contact input signal 2 type Setting and checking

39.Press the [SEL] key once.

The set screen of contact input signal 2 type is displayed on the digital display.

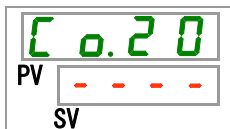

40.Select contact input signal 2 type from the table below with [▲] key or [▼] key, and confirm by pressing “SEL”.

Table 5.19-21 List of set value

Set value	Explanation	Initial value (Default setting)
----	Setting/checking are not available if the setting of contact input signal 1 is OFF.	
ALt	Alternate signal	○
nt	Momentary signal*8	

*8 Can be set when the setting of contact input signal 2 is "Run/Stop signal input" or "Remote signal"

Contact input signal 2 delay timer of reading Setting and checking

41.Press the [SEL] key once.

The set screen of contact input signal 2 delay timer of reading is displayed on the digital display.

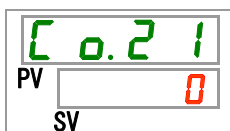

42. Select contact input signal 2 delay timer of reading from the table below with [▲] key or [▼] key, and confirm by pressing “SEL”.

Table 5.19-22 List of set value

Set value	Explanation	Initial value (Default setting)
----	Setting and checking are not available unless contact input signal 2 is external switch signal input (N.O. type or N.C. type).	
0 to 300	Setting of contact input signal 2 delay timer of reading. Set range is 0 to 300 sec.	0

Contact input signal 2 OFF detection timer Setting and checking

43. Press the [SEL] key once.

The set screen of contact input signal 2 OFF detection timer is displayed on the digital display.

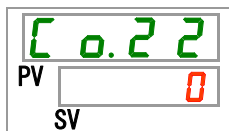

44. Select contact input signal 2 OFF detection timer from the table below with [▲] key or [▼] key, and confirm by pressing “SEL”.

Table 5.19-23 List of set value

Set value	Explanation	Initial value (Default setting)
----	Setting and checking are not available unless contact input signal 2 is external switch signal input (N.O. type or N.C. type).	
0 to 10	Setting of contact input signal 2 OFF detection timer Set range is 0 to 10sec.	0

Contact output signal 1 function Setting and checking

45. Press the [SEL] key once.

The set screen of contact output signal 1 function is displayed on the digital display.

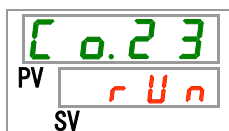

- 46.** Select contact input signal 1 function from the table below with [▲] key or [▼] key, and confirm by pressing “SEL”.

Table 5.19-24 List of set value

Set value	Explanation	Initial value (Default setting)
<input type="checkbox"/> OFF	Without output signal	
<input type="checkbox"/> rUn	Signal of operating status is output	○
<input type="checkbox"/> rñt	Signal of remote status is output	
<input type="checkbox"/> rdy	Signal for completion of preparation (TEMP READY)	
<input type="checkbox"/> A.StP	Signal for the status of the operation stop alarm is output	
<input type="checkbox"/> A.rUn	Signal for the status of the operation continue alarm is output	
<input type="checkbox"/> ALñ	Signal for the alarm status is output	
<input type="checkbox"/> A.SEL	Signal for selected alarm status is output	
<input type="checkbox"/> on.tñ	Signal for Run timer set status is output	
<input type="checkbox"/> of.tñ	Signal for Stop timer set status is output	
<input type="checkbox"/> P.rSt	Signal for the recovery from power failure is output	
<input type="checkbox"/> F.P.	Signal for anti-freezing setting is output	
<input type="checkbox"/> InP1	Pass through signal of contact input signal 1	
<input type="checkbox"/> InP2	Pass through signal of contact input signal 2	
<input type="checkbox"/> A.FIL	Signal output during automatic fluid filling	

Contact output signal 1 operation Setting and checking

- 47.** Press the [SEL] key once.

The set screen of contact output signal 1 operation is displayed on the digital display.

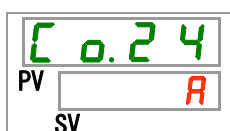

- 48.** Select contact output signal 1 operation from the table below with [▲] key or [▼] key, and confirm by pressing “SEL”.

Table 5.19-25 List of set value

Set value	Explanation	Initial value (Default setting)
<input type="checkbox"/> A	N.O type	○
<input type="checkbox"/> b	N.C type	

Contact output signal 1 selected alarm Setting and checking

- 49.** Press the [SEL] key once.

The set screen of contact output signal 1 selected alarm is displayed on the digital display.

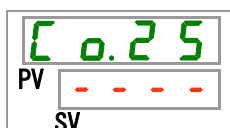

50. Select contact output signal 1 selected alarm from the table below with [▲] key or [▼] key, and confirm by pressing “SEL”.

Table 5.19-26 List of set value

Set value	Explanation	Initial value (Default setting)
----	Setting/checking are not available unless the function setting of digital output 1 is selected alarm status signal.	
AL01 to AL36	Sets selection alarm. Set range is AL.01 to AL.36.	AL01

Contact output signal 2 function Setting and checking

51. Press the [SEL] key once.

The set screen of contact output signal 2 functions are displayed on the digital display.

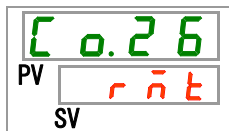

52. Select contact output signal 2 function from the table below with [▲] key or [▼] key, and confirm by pressing “SEL”.

Table 5.19-27 List of set value

Set value	Explanation	Initial value (Default setting)
OFF	Without output signal	
run	Signal of operating status is output	
rn t	Signal of remote status is output	○
rdy	Signal for completion of preparation (TEMP READY)	
ALStP	Signal for the status of the operation stop alarm is output	
ALrun	Signal for the status of the operation continue alarm is output	
ALn	Signal for the alarm status is output	
ALSEL	Signal for selected alarm status is output	
ontn	Signal for Run timer set status is output	
of.tn	Signal for Stop timer set status is output	
PrSt	Signal for the recovery from power failure is output	
F.P.	Signal for anti-freezing setting is output	
INP1	Pass through signal of contact input signal 1	
INP2	Pass through signal of contact input signal 2	
R.F.I.L	Signal output during automatic fluid filling	

Contact output signal 2 operation Setting and checking

53. Press the [SEL] key once.

The set screen of contact output signal 2 operation is displayed on the digital display.

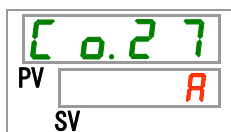

54. Select contact output signal 2 operation from the table below with [▲] key or [▼] key, and confirm by pressing “SEL”.

Table 5.19-28 List of set value

Set value	Explanation	Initial value (Default setting)
A	N.O type	○
b	N.C type	

Digital output signal 2 selected alarm Setting and checking

55. Press the [SEL] key once.

The set screen of contact output signal 2 selected alarm is displayed on the digital display.



56. Select contact output signal 2 selected alarm from the table below with [▲] key or [▼] key, and confirm by pressing “SEL”.

Table 5.19-29 List of set value

Set value	Explanation	Initial value (Default setting)
----	Setting/checking are not available unless the function setting of digital output 2 is selected alarm status signal.	
AL01 to AL36	Sets selected alarm Set range is AL.01 to AL.36.	AL01

Contact output signal 3 function Setting and checking

57. Press the [SEL] key once.

The set screen of contact output signal 3 function is displayed on the digital display.



58. Select contact output signal 3 function from the table below with [▲] key or [▼] key, and confirm by pressing “SEL”.

Table 5.19-30 List of set value

Set value	Explanation	Initial value (Default setting)
OFF	Without output signal	
run	Signal of operating status is output	
rent	Signal of remote status is output	
rdy	Signal for completion of preparation (TEMP READY)	
ALSTP	Signal for the status of the operation stop alarm is output	
ALRun	Signal for the status of the operation continue alarm is output	
ALn	Signal for the alarm status is output	○
ASEL	Signal for selected alarm status is output	
ontn	Signal for Run timer set status is output	
ofent	Signal for Stop timer set status is output	
PrSt	Signal for the recovery from power failure is output	
F.P.	Signal for anti-freezing setting is output	
INP1	Pass through signal of contact input signal 1	
INP2	Pass through signal of contact input signal 2	
RFIL	Signal output during automatic fluid filling	

Contact output signal 3 operation Setting and checking

59. Press the [SEL] key once.

The set screen of contact output signal 3 operation is displayed on the digital display.

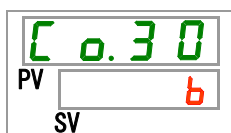

60. Select contact output signal 3 operation from the table below with [▲] key or [▼] key, and confirm by pressing “SEL”.

Table 5.19-31 List of set value

Set value	Explanation	Initial value (Default setting)
A	N.O type	
b	N.C type	○

Contact output signal 3 selected alarm Setting and checking

61. Press the [SEL] key once.

The set screen of contact output signal 3 selected alarm is displayed on the digital display.



62. Select contact output signal 3 selected alarm from the table below with [▲] key or [▼] key, and confirm by pressing “SEL”.

Table 5.19-32 List of set value

Set value	Explanation	Initial value (Default setting)
- - - -	Setting/checking are not available unless the function setting of digital output 3 is selected alarm status signal.	
AL.01 to AL.36	Sets selected alarm Set range is AL.01 to AL.36.	AL.01

63. Press the [MENU] key once.

Return to the main screen (screen displaying the circulating fluid temperature).

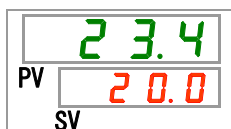

Chapter 6 Option·Optional Accessories

6.1 Option J [Automatic fluid filling]

6.1.1 Option J [Automatic fluid filling]

This function is available for customers who selected automatic fluid filling.

Refer “3.6 Option J Piping of 【Automatic fluid filling】” for the installation of the automatic fluid filling.

Piping to the automatic fluid filling port enables easy supply of the circulating fluid through the level switch in the tank.

- Starts supplying the circulating fluid automatically when the circulating fluid amount in the tank is small.
- Stops supplying the circulating fluid automatically when the circulating fluid is filled in the tank.
- Automatic fluid filling does not start when alarm of table 5-19-1 is generated. Fluid filling stops if the filling is automatic.

Table 6.1-1 Table of alarms automatic fluid filling stops / does not start

Code	Description	Code	Description
AL02	High circulating fluid discharge temp.	AL17	Refrigerant circuit pressure (low pressure side) drop
AL05	High circulating fluid return temp.	AL18	Compressor overload
AL06	High circulating fluid discharge pressure	AL20	Memory error
AL07	Abnormal pump operation	AL22	Circulating fluid discharge temp. sensor failure
AL10	High compressor intake temp.	AL23	Circulating fluid return temp. sensor failure
AL11	Low compressor intake temp.	AL24	Compressor intake temp. sensor failure
AL12	Low super heat temperature	AL25	Circulating fluid discharge pressure sensor failure
AL13	High compressor discharge pressure	AL26	Compressor discharge pressure sensor failure
AL15	Refrigerant circuit pressure (high pressure side) drop	AL27	Compressor intake pressure sensor failure
AL16	Refrigerant circuit pressure (low pressure side) rise	AL33	Water leakage

CAUTION



- This function starts both in stand-by condition (power supply switch is ON) and in operation.
- The freezing of the automatic fluid filling circuit can not be prevented if an anti-freezing function is used. To be arranged by the user.

6.2 Option M [DI water (Pure water) piping]

6.2.1 Option M [DI water (Pure water) piping]

This option is for customers who use DI water (pure water) as circulating fluid.

Circulating fluid wetted materials	Stainless (I include heat exchanger brazing), SiC, Carbon, PP, PE, POM, FKM, EPDM, PVC (No. copper used)
------------------------------------	--

- Serviceable conductivity: 0.22μS/cm or more. (Resistivity: 4.5MΩ·cm or less.)
- This option doesn't include a function to maintain high resistivity/conductivity.
You need ion exchange resin filter (DI filter) for the purpose.
(Optional accessory: DI filter set: HRS-DP001)

6.3 Option T [High-pressure pump]

6.3.1 Option T [High-pressure pump]

With option T (high pressure pump), the discharge pressure is raised.

- The high head pump uses a mechanical seal.
- Thermo Chiller makes AL28 alarm when driving time is passed a recommended preventive maintenance hours. Please contact to service center to ask for maintenance of the pump and mechanical seal.

Applicable model		HRS040-□-20-T/MT ^{Note 1)}	
Pump	Rated flow (50/60Hz) ^{Note 2) 3)}		23(0.18MPa)/28(0.23MPa)
	Maximum flow rate (50/60 Hz)	L/min	30/35
	Maximum pump head (50/60 Hz)	m	50
	Output	W	550
Recommended earth leakage breaker capacity		A	20
Cooling capacity ^{Note 4)}		W	The cooling capacity reduces about 300 W from the value in the catalog.

Note 1) -MT: Applicable to deionized water piping + High pressure pump

Note 2) The capacity at the thermo-chiller outlet when the circulating fluid temperature is 20° C.

Note 3) Required minimum flow rate for cooling capacity or maintaining the temperature stability.

Note 4) Cooling capacity will decrease as pump power increases.

Note 5) When the option, high pressure pump mounted, is selected, the weight increases by 6 kg.

*No change in external dimensions

6.4 Optional Accessories [Electric resistivity /conductivity sensor set]

6.4.1 Optional Accessories [Electric resistivity/conductivity sensor set]

This function is available for customers who have purchased the electric resistivity/conductivity sensor set which is a separately sold accessory. Refer to the Operation Manual attached to these optional accessories for details.

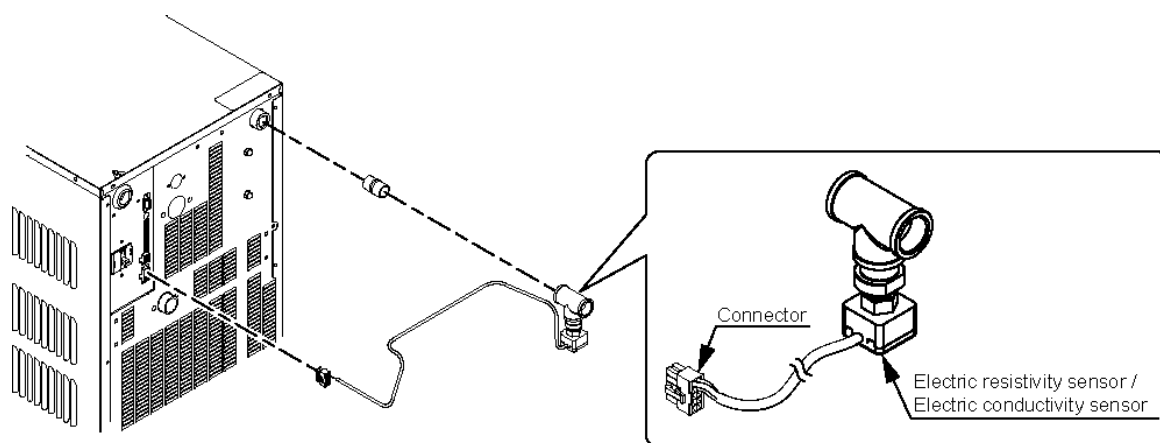

Fig 6.4-1 Optional Accessories [Electric resistivity/conductivity sensor set]

6.5 Optional Accessories [Drain pan set]

6.5.1 Optional Accessories [Drain pan set]

This function is available for customer who purchased drain pan set (part no.: HRS-WL002). For the installation of the drain pan, refer to the Operation Manual of the “Drain pan set”.

Water leakage can be detected by this function. “AL33 Leakage” is generated when water leakage is detected.

It is possible to set the operation when the alarm is generated. Refer to the “5.15 Alarm customize function” for details.

CAUTION



Alarm “AL33 Fluid leakage” be generated if this setting is valid with the water leakage detector not being connected. Make this setting valid after installing the drain pan set properly.

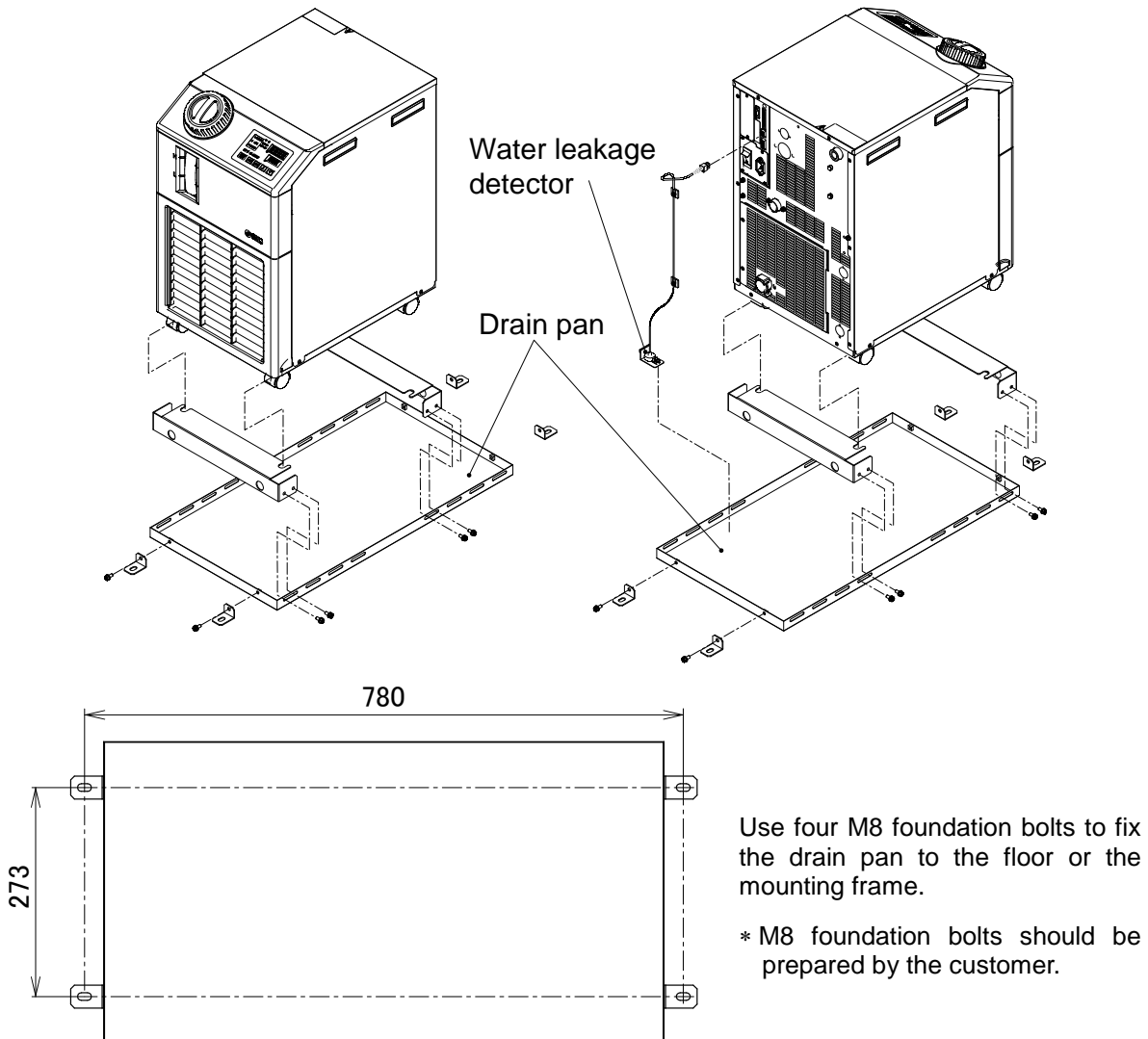

Fig 6.5-1 Optional Accessories [Drain pan set]

6.5.2 Optional Accessories [Drain pan set] setting and checking

The table below explains the setting items of the optional accessories [Drain pan set] and the initial values.

Table 6.5-1 List of set optional accessories [Drain pan set]

Display	Item	Contents	Initial value (Default setting)
SE.18	Optional accessories [Drain pan set]	Set the optional accessories [Drain pan set] mode to valid / invalid.	OFF

1. Press and hold the [MENU] key for approx. 2 sec.

Repeat pressing the key until the setting screen for key-lock [SE.01] appears on the digital display.

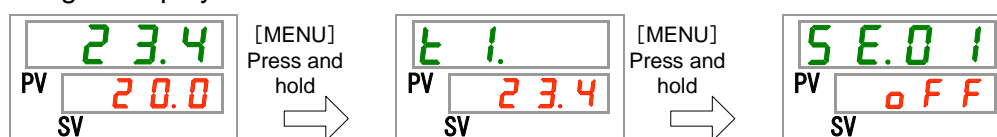

Drain pan set [Option] Setting and checking

2. Press the [SEL] key 17 times.

The set screen of drain pan set [Optional Accessories] is displayed on the digital display.

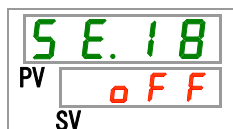

3. Select drain pan set [Optional Accessories] from the table below with [▲] key or [▼] key, and confirm by pressing "SEL".

Table 6.5-2 List of set value

Set value	Explanation	Initial value (Default setting)
OFF	Drain pan set [optional accessories] mode to invalid	○
ON	Drain pan set [optional accessories] mode to valid	

4. Press the [MENU] key once.

Return to the main screen (screen displaying the circulating fluid temperature).

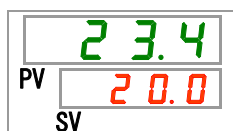

Chapter 7 Alarm indication and trouble shooting

7.1 Alarm Display

When any alarm occurs, the product responds with the following conditions.

- The [ALARM] lamp will flash.
- The alarm buzzer sounds.
- The alarm no. is displayed on PV.
- Contact signal of contact input/output communication is output.
Refer to the Operation Manual for communication for details.
- Read alarm status with serial communication.
Refer to the Operation Manual for communication for details.
- The thermo-chiller has two types of operation depending on the alarm status.

One alarm type will stop operation when an alarm is generated during operation. The other type will not stop operation even when an alarm is generated.

Refer to the "Table 7-1 Alarm code list and Troubleshooting". When the operation is forced to stop, the product cannot restart until the alarm is reset.

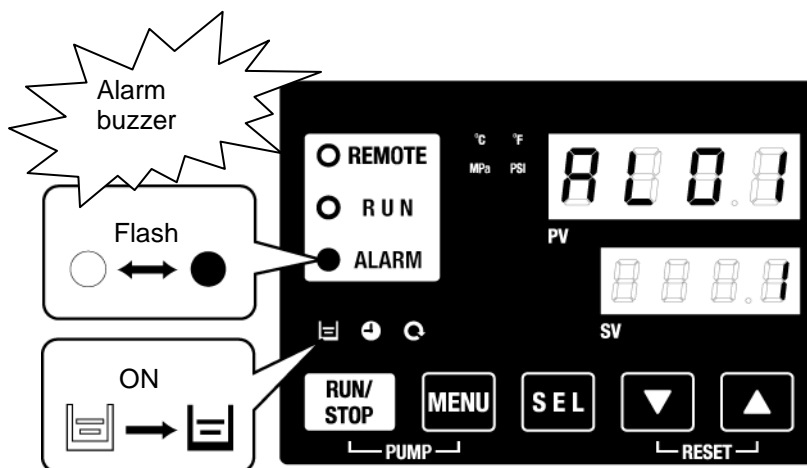

* [ lamp lights only when AL01 Low tank level is generated.

- When multiple alarms are generated, the alarms are displayed one by one by pressing the [SEL] key

Alarm with no.1 on the digital display SV is the latest alarm. The alarm with the highest number is the alarm that was generated first.

【Example of display】

The temperature rises gradually, and alarms are generated in the order AL03, AL06, AL02.

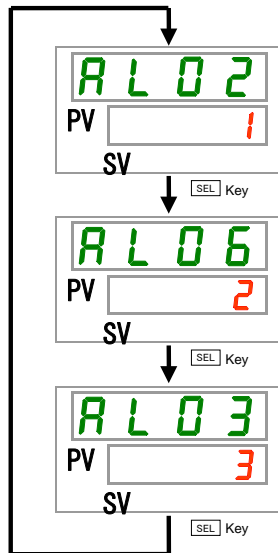

The alarm code displayed on the operation panel is AL02. AL06, AL03 are displayed by pressing the [SEL] key.

Digital display SV displays “3” when AL03 is displayed. In this example, AL03 is the highest number. This means AL03 is the alarm generated first.

7.2 Alarm buzzer stop

The alarm buzzer sounds to notify when the alarm signal is output. How to stop the alarm buzzer.

- Ensure that the alarm display screen is displayed.
The alarm buzzer can only be stopped on this screen.
- Press [▼] and [▲] keys down simultaneously..
- The alarm buzzer is stopped.

[Tips]

- The alarm buzzer can be set not to make sound. Refer to 5.15 Alarm buzzer sound setting". The procedure to stop the alarm buzzer is not necessary when the buzzer is set not to make a sound.
- If this procedure is performed when the cause of the alarm has been eliminated before stopping the alarm buzzer, the alarm will be reset at the same time.

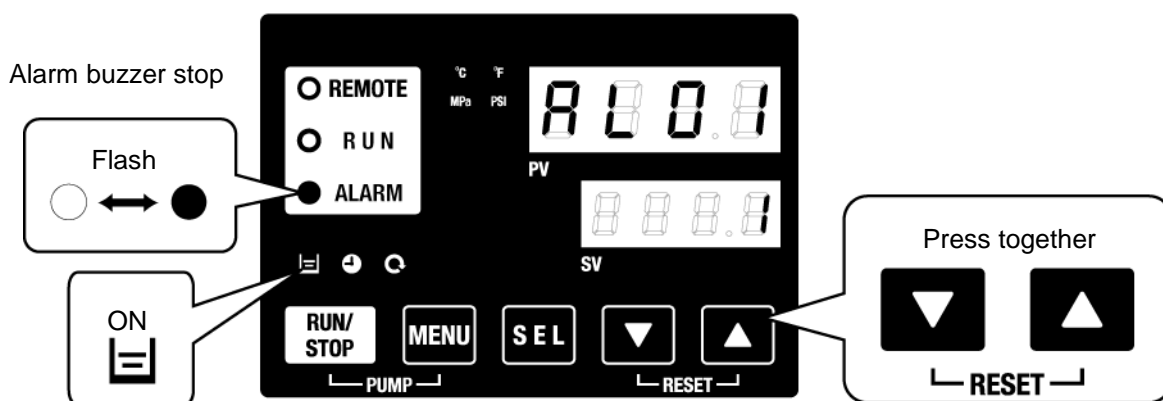

* [ lamp lights only when AL01 Low tank level is generated.

7.3 Troubleshooting

The troubleshooting method depends which alarm has been generated. Refer to "Table 7-1 Alarm code list and Troubleshooting".

This page explains how to reset the alarm signal condition after eliminating the cause of the alarm.

- Ensure that the alarm display screen is displayed.

Alarm can only be reset on this screen.

- Press [▼] and [▲] keys down simultaneously..
- The alarm is reset.

The [ALARM] lamp goes off.

The operation panel displays the circulating fluid temperature and the circulating fluid set temperature.

The contact signal of the contact input/output communication stops.

(Refer to the Operation Manual for communication for details.)

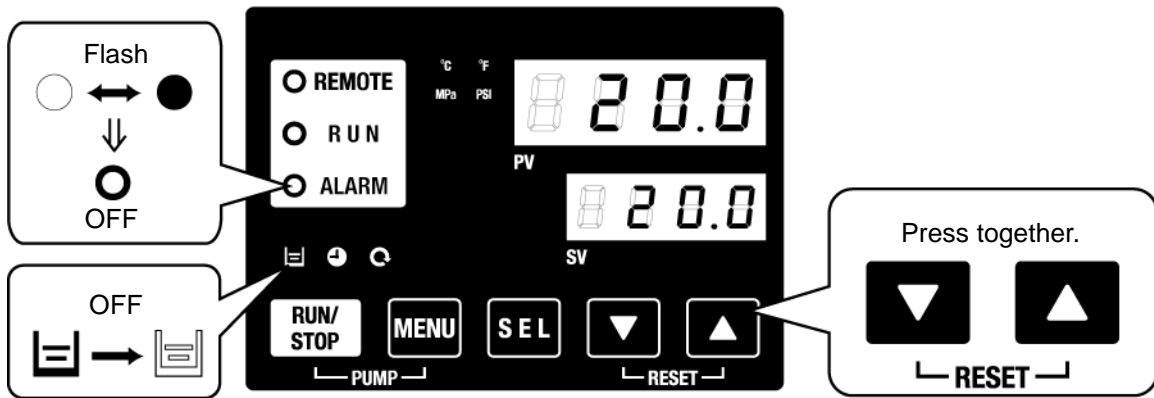

* [ lamp lights only when AL01 Low tank level is generated.

Table 7-1 Alarm code list and Troubleshooting (1/2)

Code	Description	Operation	Cause / Remedy (Press the reset key after eliminating the cause.)
AL01	Low level in tank	Stop *1	The fluid level has fallen below the level indicator. Fill the circulating fluid.
AL02	High circulating fluid discharge temp.	Stop	<ul style="list-style-type: none"> • Ensure that the circulating fluid flow is 7l/min. or more. • Reduce the ambient temperature or heat load. • Wait until the temperature decreases.
AL03	Circulating fluid discharge temp. rise	Continued *1	
AL04	Circulating fluid discharge temp.	Continued *1	Check the ambient temperature condition and the temperature of supplied circulating fluid.
AL05	High circulating fluid return temp.	Stop	<ul style="list-style-type: none"> • Ensure that the circulating fluid flow is 7l/min. or more. • Check the heat load are within the specified range.
AL06	High circulating fluid discharge pressure	Stop	Check the user's piping for bends, squash and foreign matters.
AL07	Abnormal pump operation	Stop	Restart and check the pump is operating.
AL08	Circulating fluid discharge pressure rise	Continued *1	Check the user's piping for bends, pinching or blockage by foreign matters.
AL09	Circulating fluid discharge pressure drop	Continued *1	<ul style="list-style-type: none"> • Restart and check the pump is operating. • Ensure that the tank level is within the appropriate range.
AL10	High compressor intake temp.	Stop	Check the temperature of the circulating fluid returning to the product.
AL11	Low compressor intake temp.	Stop	<ul style="list-style-type: none"> • Check the circulating fluid flows. • Check the circulating fluid in the evaporator is not frozen. • Use a 15% ethylene glycol aqueous solution if operating with a set temperature lower than 10°C.
AL12	Low super heat temperature	Stop	
AL13	High compressor discharge pressure	Stop	Reduce the ambient temperature or heat load.
AL15	Refrigerant circuit pressure (high pressure side) drop	Stop	<ul style="list-style-type: none"> • Check the ambient temperature is within the specified range. • It is possible that refrigerant is leaking. Ask for the service.
AL16	Refrigerant circuit pressure (low pressure side) rise	Stop	Reduce the ambient temperature or heat load.
AL17	Refrigerant circuit pressure (low pressure side) drop	Stop	<ul style="list-style-type: none"> • Check the circulating fluid flows. • It is possible that refrigerant is leaking. Ask for the service.
AL18	Compressor overload	Stop	Leave for 10 minutes and restart, and check the compressor is operating.
AL19 *2	Communication error *2	Continued *1	The request message from the host computer has not arrived. Send it again.
AL20	Memory error	Stop	Written data is different from read data. Ask for the service of RAM.
AL21	DC line fuse cut	Stop *1	DC circuit fuse of the communication connector for the contact input/output is short circuited. Ask for the service of the fuse of the DC circuit. Confirm there is no incorrect wiring or load of 500mA or larger.
AL22	Circulating fluid discharge temp. sensor failure	Stop	The temperature sensor is short-circuited or opened. Ask for the service of the temperature sensor.
AL23	Circulating fluid return temp. sensor failure	Stop	
AL24	Compressor intake temp. sensor failure	Stop	
AL25	Circulating fluid discharge pressure sensor failure	Stop	The pressure sensor is short-circuited or opened. Ask for the service of the pressure sensor.
AL26	Compressor discharge pressure sensor failure	Stop	
AL27	Compressor intake pressure sensor failure	Stop	

Table 7-2 Alarm code list and Troubleshooting (2/2)

Code	Description	Operation	Cause / Remedy (Press the reset key after eliminating the cause.)	
AL28	Maintenance of pump	Continued	The timing of a periodical check is informed.	Every 20,000 hours
AL29 *3	Maintenance of fan motor*3	Continued	Recommended to ask for the check and service of the pump, fan motor and compressor. *Refer to "5.18 Accumulated time reset function".	Every 20,000 hours
AL30	Maintenance of compressor	Continued		Every 50,000 hours
AL31 *3	Contact input 1 signal detection *3	Stop *1		Contact input is detected.
AL32 *3	Contact input 2 signal detection *3			
AL33	Water leakage	Stop *1	<ul style="list-style-type: none"> • Check if the leakage sensor is connected. • Leakage occurred. Check the leakage point. 	
AL34	Electric resistivity/conductivity rise	Continued	Electric resistivity/conductivity is larger than the set value. If an electric conductivity sensor is used, replace the DI filter.	
AL35	Electric resistivity/conductivity drop	Continued	Electric resistivity/conductivity is smaller than the set value. If an electric resistivity sensor is used, replace the DI filter.	
AL36	Electric resistivity/conductivity sensor error	Continued	<ul style="list-style-type: none"> • Check if the resistivity/conductivity sensor is connected. • There may be short circuit or open wire of the resistivity /conductivity sensor. Replace the sensor. 	

*1: "Stop" or "Continued" are default settings. The user can change them to "Continued" and "Stop". For details, refer to "5.16 Alarm customize function".

*2: "AL19, Communication error" is disabled in the default setting. When this function needs to be enabled, refer to "5.19 Communication function".

*3: The functions of "AL31 Contact input 1 Signal detection" and "AL32 Contact input 2 Signal detection" are not default settings. If these functions are used, refer to "5.19 Communication function".

*4: For air-cooled type.

7.4 Other Errors

■ How to check other errors

The causes and remedies for failures that are not indicated by alarm numbers are shown in "Table 7-3".

Table 7-3 Causes and remedies for failures without alarm number

Content of failure	Cause	Remedy
The operation panel displays nothing	The breaker is not turned on.	Turn on the breaker.
	Failure of the breaker.	Replace the breaker.
	No power supply (The breaker for the power supply is not turned on.)	Supply the power.
	Trip of breaker due to short-circuit and current leakage	Repair the short-circuit or current leaking part.
The [RUN] LED does not light up even when the [RUN/STOP] switch is pressed.	Communication is set.	Check the presence of communication setting.
	Failure of the [RUN] LED	Replace the controller.
	Failure of the [RUN/STOP] switch	Replace the controller.

Chapter 8 Control, Inspection and Cleaning

8.1 Control of Circulating Fluid Quality

⚠ WARNING



Use specified circulating fluids only. If other fluids are used, they may damage the product or result in dangerous hazards. When using fresh water (tap water) ensure that it satisfies the water standard shown in the table below.

Table 8-1 Quality standard for fresh water (tap water)

	Item	Product	Standard value	
			For circulating fluid	For facility water
Standard item	pH (at 25°C)	—	6.0 to 8.0	6.5 to 8.2
	Electric conductance (at 25°C)	[μS/cm]	100 to 300	100 to 800
	Chloride ion	[mg/L]	50 or less	200 or less
	Sulfuric acid ion	[mg/L]	50 or less	200 or less
	Acid consumption (at pH 4.8)	[mg/L]	50 or less	100 or less
	Total hardness	[mg/L]	70 or less	200 or less
	Calcium hardness	[mg/L]	50 or less	150 or less
	Ion silica	[mg/L]	30 or less	50 or less
Referential item	Iron	[mg/L]	0.3 or less	1.0 or less
	Copper	[mg/L]	0.1 or less	0.3 or less
	Sulfide ion	[mg/L]	Not detected	Not detected
	Ammonium ion	[mg/L]	0.1 or less	1.0 or less
	Residual chlorine	[mg/L]	0.3 or less	0.3 or less
	Separation carbonic acid	[mg/L]	4.0 or less	4.0 or less

* Quoted from JRA-GL-02-1994, The Japan Refrigeration and Air Conditioning Industry Association.

CAUTION



Clean the tank, circulating fluid circuit, and change the circulating fluid in the tank if any problems are found during the regular check. Additionally, even if no problems are found, it is necessary to change the fluid once every 3 months in case evaporation of the fluid causes concentration of impurities. Refer to the page containing "8.2 Inspection and Cleaning" for the regular check.

8.2 Inspection and Cleaning

⚠ WARNING



- Do not operate switches, etc. with wet hands and do not touch the electrical parts such as the power supply plug. It might cause electric shock.
- Do not splash water directly on the product and do not wash with water. It might cause electric shock and fire, etc.
- Do not touch the fins directly when cleaning the dustproof filter. It might cause injury.

⚠ WARNING



- Shut off the power supply of the product when performing cleaning, maintenance or inspection. It might cause electric shock, injury or burn, etc.
- Replace all panels removed for inspection or cleaning. It might cause injury or electric shock if it is operated with the panel removed or open. Do not operate switches, etc. with wet hands and do not touch the electrical parts such as the power supply plug. It might cause electric shock.

8.2.1 Daily check

Check each item of Table 8-2 below, and if any error is seen, stop the operation of the product and turn off the user's power supply, and service the product.

Table 8-2 Contents of daily check

Item	Content of check	
Installation condition	Check the installation conditions of the product.	There is no heavy object on the product or excessive force on the piping.
		Temperature and humidity are within the specified range of the product.
Fluid leakage	Check the connected part of piping	There is no circulating fluid leakage from the connected part of piping.
Fluid amount	Check the liquid level indicator.	The circulating fluid must enter the scale of "H".
Operation panel	Check the display.	The numbers on the display are clear.
	Check the function.	The [RUN/STOP] and [MENU], [SEL], [▼], [▲] buttons operate properly.
Circulating fluid discharge pressure	Check on the operation panel.	There is no problem for use.
Operating conditions	Check the operation condition.	There is no abnormal noise, vibration, smell and smoke. There should be no active alarm signal.
Ventilating condition (For air-cooled type)	Check the condition of the ventilation grille.	Make sure the ventilation grille is not obstructed.
Facility water supply (For water-cooled type)	Check the supply condition to the thermo chiller.	Temperature, flow rate and pressure are within the specified range.

8.2.2 Monthly check

Table 8-3 Contents of Monthly check

Item	Content of check	
Ventilating condition (For air-cooled type)	Clean the ventilation grille.	Make sure the ventilation grille is not clogged with dust, etc.
Facility water supply (For water-cooled type)	Check the facility water.	Make sure the facility water is clean and contains no foreign matter.
Automatic water supply (Option J: Automatic water supply)	Check the supply water.	Make sure the supply water is clean and contains no foreign matter.

■ Cleaning of air vent (For air-cooled type)

CAUTION
<ul style="list-style-type: none"> ● If the fins of the air-condenser become clogged with dust or debris, heat radiation performance reduces. This results in the reduction of cooling performance, and may stop the operation because the safety device is triggered. Shut off the power supply of the product when performing cleaning, maintenance or inspection. It might cause electric shock, injury or burn, etc. ● Replace all panels removed for inspection or cleaning. It might cause injury or electric shock if it is operated with the panel removed or opened.

Use a long bristled brush or air gun to clean the condenser to prevent the fins from being deformed or damaged.

■ Removal of the dustproof filter

1. The dustproof filter is installed at the lower part of the front face of the thermo-chiller. It is mounted with a magnet. The dustproof filter is divided into two sections. They are identical.

2. They can be removed as shown in the drawing below. Care should be taken not to deform or scratch the air-cooled condenser (fin) while the removal.

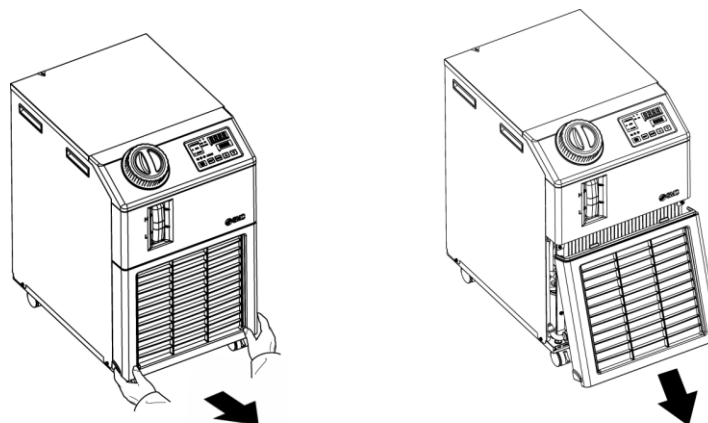

Fig. 8-1 Removal of the dustproof filter

■ Cleaning of filter

Use a long bristled brush or air gun to clean the condenser.

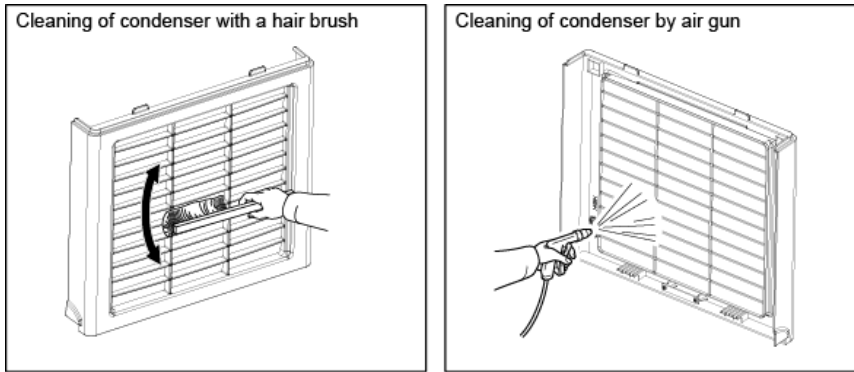

Fig. 8-2 Cleaning of filter

■ Mounting of dustproof filter

Insert the collar in reverse order of removal, then mount the dustproof filter. The magnet clicks when mounted.)

8.2.3 Inspection every 3 months

Table 8-4 Contents of every 3 months check

Item	Content of check	
Power supply	Check the power supply voltage.	- Make sure the supply voltage is within the specification range.
Circulating fluid	Replace the circulating water (clean water) periodically. Clean the tank.	- Ensure that the water has not been contaminated and that there is no algae growth. - Circulating water inside the tank must be clean and there must not be foreign matter inside. - Use clean water or pure water. The water quality must be within the range shown in Table 8-1. * It is recommended to replace the circulating fluid every 3 months when periodic maintenance is performed.
	Density control (When using 15% concentration ethylene glycol aqueous solution)	- Density must be within the range of 15 % +5/-0.
Facility water (For water-cooled type)	Check the water quality.	- Ensure that the water is clean and contains no foreign matter. Also check that the water has not been contaminated and there is no algae growth. - The water quality must be within the range shown in Table 8-1.

■ Replacement of circulating fluid

- Clean the tank and replace the circulating fluid (clean water).
- For the circulating fluid, select from the specification range shown in "Table 8-1 Quality standard for fresh water (tap water)".
- When using 15% ethylene glycol solution, check that the concentration is within the range of 15% +5/-0.

■ Replacement of circulating fluid (For water cooled type)

- Clean the facility water source and replace the facility water.
- For the circulating fluid, select from the specification range shown in Table 8-1 Quality standard for fresh water (tap water).

8.2.4 Inspection every 6 months

■ Check for water leakage from pump

Remove the panel and check the pump for excessive leakage. If the leakage is found, replace the mechanical seal. Order the mechanical seal described in "8.3 Consumables" as a service part.

CAUTION

- **Leakage from the mechanical seal**
It is impossible to prevent the leakage from the mechanical seal completely because of its structure. Although the leakage is described as 3cc/hr or less.
- **The recommend life time of the mechanical seal before needing replacement is 6000 to 8000 hours (usually 1 year)**

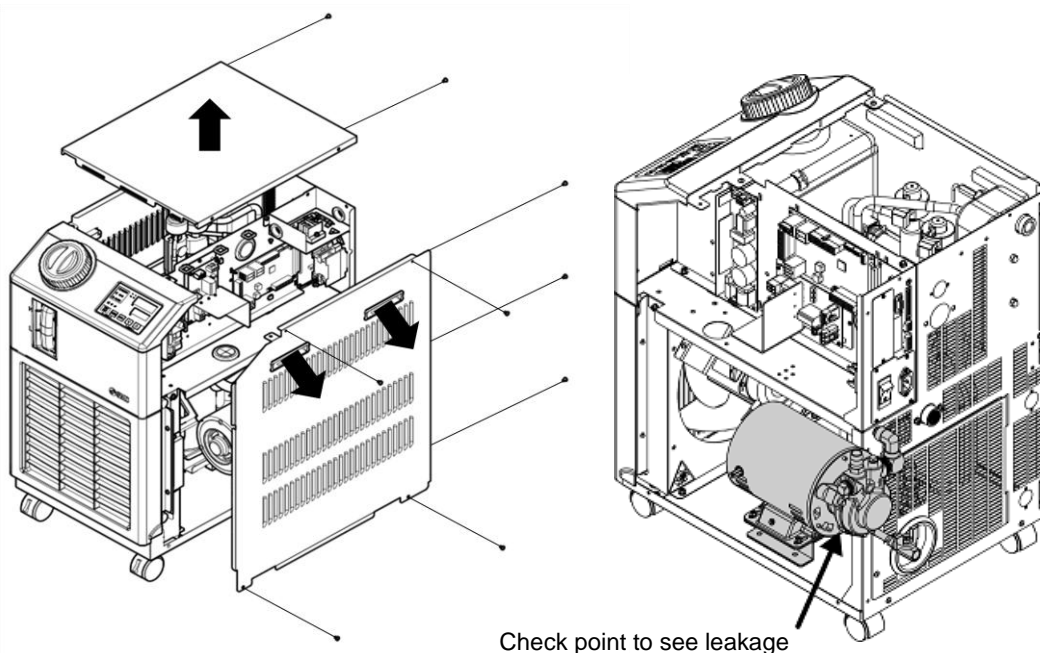

Fig. 8-3 Check for water leakage from pump

8.2.5 Inspection for winter season

■ Prevention of freezing of circulating fluid

The product can prevent freezing of the circulating fluid during winter or at night. If there is a risk of freezing due to a change of installation conditions and operating environment (operating time, weather etc.), conduct the following operations in advance.

■ Anti-freezing function (automatic pump operating function)

- When the circulating fluid temperature reaches 3°C, the pump will start automatically.
- The operation of pump will heat the circulating fluid with its power. Then, when the circulating fluid temperature reaches 5 °C, the pump will stop automatically.
- As a result, the circulating fluid temperature is kept between 3 and 5 °C, and can be prevented from freezing.
- The operation cannot prevent freezing of the facility water circuit (For water cooled type). The user should take measures against freezing.
- This function does not prevent the freezing of the automatic fluid filling circuit (when the option is selected). The measure for the automatic fluid filling circuit is taken by customer.

*For details refer to “5.11 Anti-freezing function”.

1. Keep the power supply on. (RUN lamp flashes at 2sec. intervals.)

2. Fully open the valve and manual relief valve installed by the user, to ensure the circulating fluid will be able to circulate when the pump starts automatically.

CAUTION



- **This function cannot prevent freezing of the product completely if the installation area is exposed to severe cold weather conditions. In such conditions, consult with a specialized vendor to install other anti-freezing equipment (commercial tape heater, etc.).**
- **Also, the facility water circuit does not have a similar function.**
- **Also, the automatic water-fill circuit does not have a similar function.**

8.3 Consumables

Replace the following parts depending on their condition.

Table 8-5 Consumables

Part number	Name	Qty.	Remarks
HRS-S0001	Dustproof filter	1	For spare
HRG-S0211	Mechanical seal set	1	Option T (High head pump)

8.4 Stop for a Long Time

If there is a concern that the product will not be operated for a long period of time or there is a risk of freezing, conduct the following operations.

1. Turn off the user's power supply (breaker).
2. Drain the circulating fluid and facility water (for water-cooled type) of the product completely.
Please refer to "8.4.1 Discharge of the circulating fluid" for the method of drain the circulating fluid from the product.
3. After draining, cover the product with vinyl, etc. and store.

8.4.1 Discharge of the circulating fluid and facility water

⚠ WARNING



- Stop the customer device and release the residual pressure before discharging the circulating fluid.
- Before discharging the facility water, in case of water-cooled refrigerated type, stop the equipment for the facility water, or stop the facility water circuit to release the residual pressure.

1. Place a container underneath the drain outlet.
(The capacity of the container should be approx. 10L.)

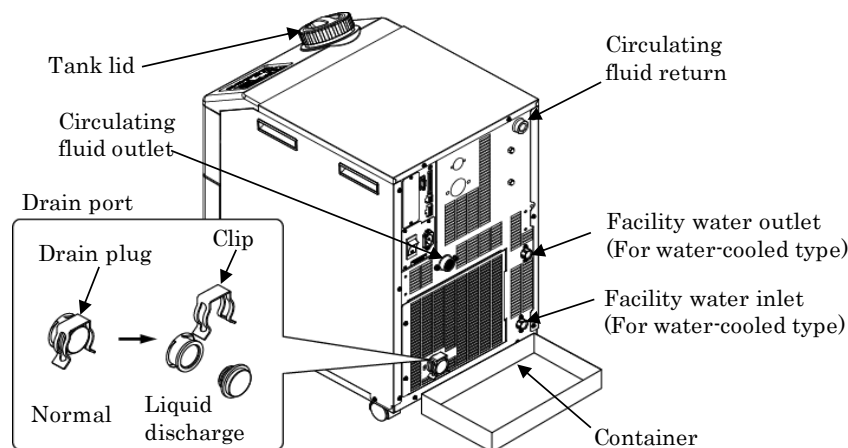

Fig. 8-4 Drain the circulating fluid and facility water from the product

2. Remove the tank lid.
3. Remove the drain plug on the drain port on the piping to discharge the fluid.
An O ring is used for the drain plug. Take care not to damage the O ring.
4. Confirm that a sufficient amount of the circulating fluid has been drained from the user's machine and piping, and apply air purge from the circulating fluid return port.
5. Confirm that a sufficient amount of the circulating fluid has been drained from the user's machine and piping, and apply air purge from the circulating fluid return port.

<For the water-cooled refrigeration chiller, drain the facility water according to the procedures from 6 to 8.>

- 6. After the circulating fluid finishes has drained from the tank, close the ball valve at the drain port and put the tank lid back.
- 7. Remove the dustproof filter to remove the plug. Please refer P8-3 for the procedure of removal.

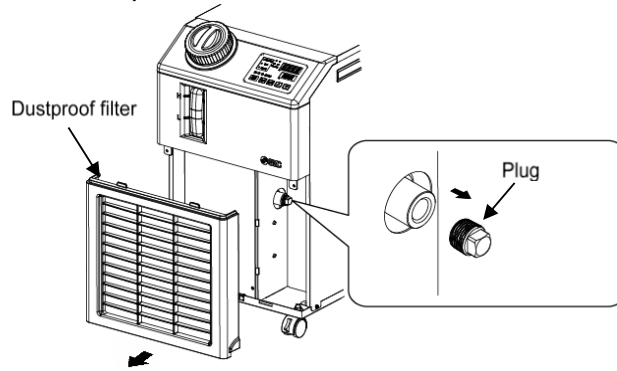



Fig. 8-5 Removal of the plug

CAUTION

 Just removing the facility water piping does not discharge the facility water completely. Remove the plug to discharge the facility water.

- 8. After ensuring that the facility water is completely discharged, apply the sealant tape to the plugs which are removed during step 7 for mounting. Mount the dustproof filter after mounting them. Please refer P 8-4 for how to mount.
- 9. Refer to Fig. 8-6 to mount the plug to the piping of the product.

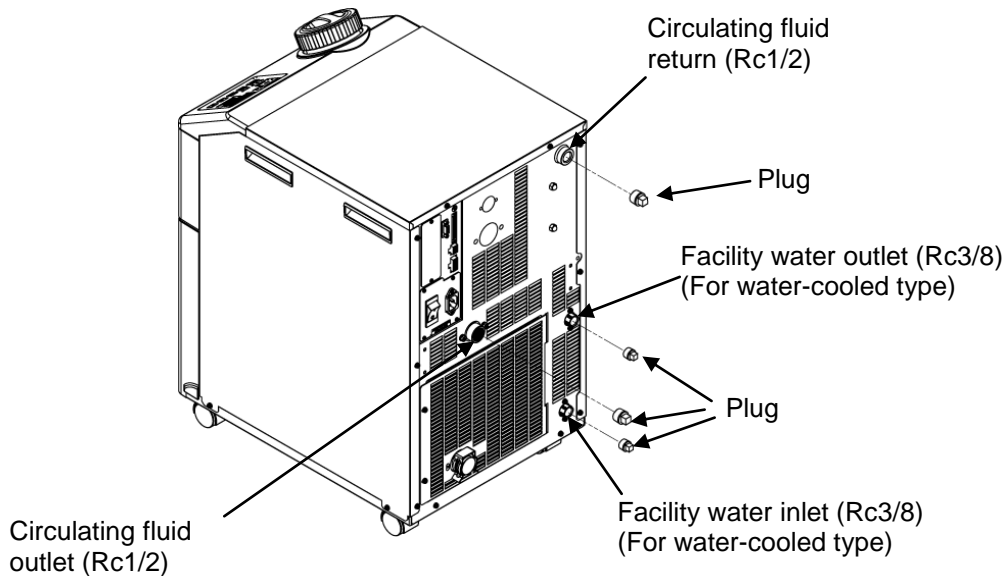

Fig. 8-6 Plug to the piping of the product

■ **Fitting for the drain port (Accessory)**

The thermo-chiller includes the fitting for the drain port shown in Fig. 8-7 .

Discharging of the drain will be easier if customer prepares a valve.

The valve has to be connected to the drain port fitting.

If the valve is connected far away from the drain port fitting, it cause an air trap.

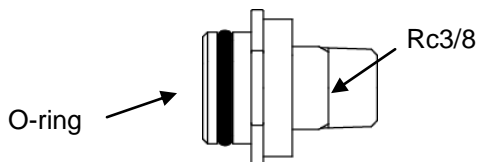

Fig. 8-7 Fitting for the drain port (Accessories)

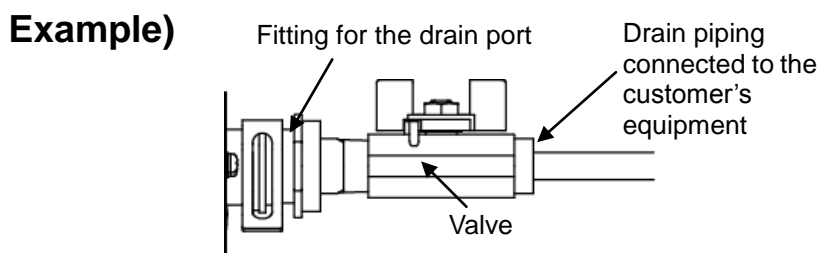

Fig. 8-8 Example of using fitting for the drain port

■ **Option T [High pressure pump]**

The ball valve is the drain port. Open the ball valve to discharge the circulating fluid in the same way as procedure 1 to 9. Close the ball valve after discharging the circulating fluid.

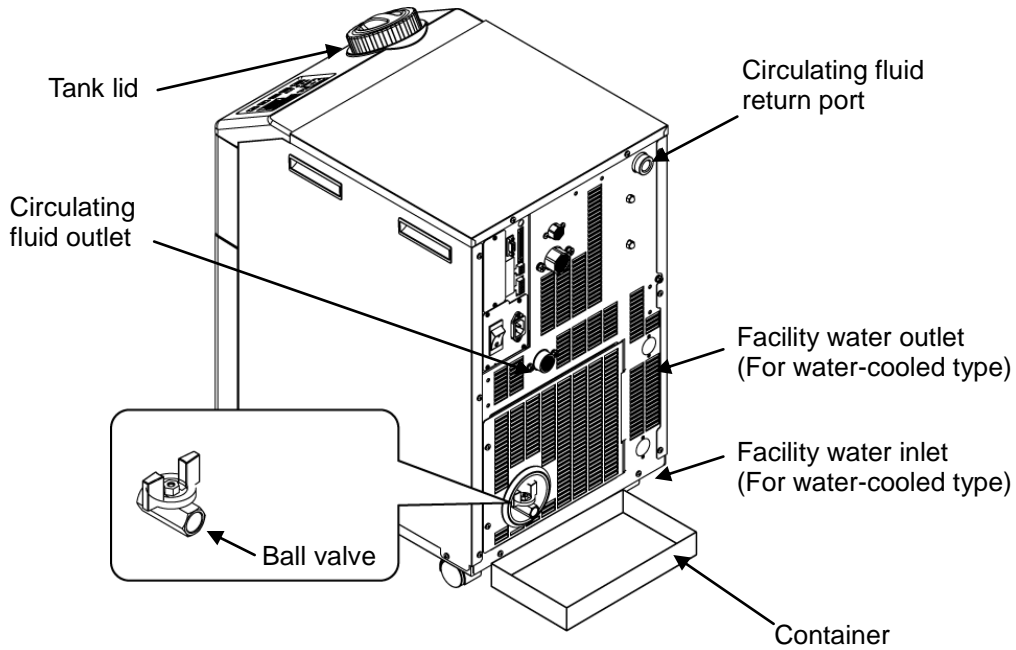

Fig. 8-8 Drain the circulating fluid and facility water from the product for option T [High pressure pump]

■ **Connection to the drain (ball valve)**

When connecting piping to the drain (ball valve), fix the ball valve with a spanner.

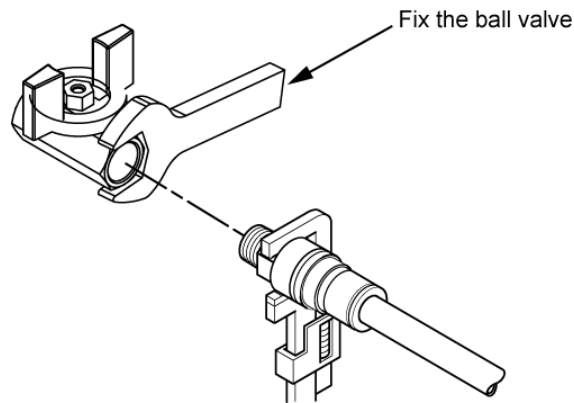



Fig. 8-9 Connection to the drain

CAUTION

 **If you do not fix the ball valve during piping, the ball valve will rotate, causing fluid leakage or malfunction. Fix the ball valve during piping.**

Chapter 9 Documents

9.1 Specifications List

9.1.1 Product specification

Table 9-1 Specifications List [HRS040-**-20-(BJMTW)]

Model		HRS040-A*-20-(BJMTW)	HRS040-W*-20-(BJMTW)
Cooling method		Air-Cooled refrigerated type	Water-Cooled refrigerated type
Refrigerant		R410A (HFC)	
Quantity of refrigerant	kg	0.53	0.60
Control method		PID control	
Ambient temperature and humidity ^{*1}		Temperature : 5 to 40°C、 Humidity: 30 to 70%	
Circulating fluid system	Circulating fluid ^{*2}		Tap water, Ethylene glycol aqueous solution 15% ^{*4}
	Operating temperature range ^{*1}	°C	5 to 40
	Cooling capacity ^{*3} (50/60Hz)	W	3800/4200
	Temperature stability ^{*5}	°C	±0.1
	Pump capacity ^{*6} (50/60Hz)	MPa	0.13(at 7L/min)/0.18(at 7L/min) For option -T:0.18(at 23L/min)/0.23(at 28L/min)
	Rated flow ^{*7} (50/60Hz)	L/min	7/7 For option -T:23/28
	Tank capacity	L	Approx. 5
	Port size		Rc1/2
Wetted material		Stainless steel, Copper brazing (Heat exchanger) ^{*13} , Bronze ^{*13} Brass ^{*13} , SIC, Carbon, PP, PE, POM, FKM, EPDM, PVC,NBR	
Facility water outlet system ^{*16}	Temperature range	°C	-
	Pressure range	MPa	-
	Required flow ^{*17}	L/min	-
	Facility water pressure differential	MPa	-
	Port size		-
Wetted material		Stainless steel, Copper brazing (Heat exchanger), Bronze, Synthetic rubber	
Automatic fluid filling ^{*12}	Feed water pressure range	MPa	0.2 to 0.5
	Feed water temperature range	°C	5 to 40
	Feed water capacity	L/min	Approx. 1
	Automatic fluid filling Port size		Rc3/8
	Over flow port Port size		Rc3/4
Electric system	Power supply		AC200 to 230V, 50/60Hz. Allowable voltage range ±10%
	Breaker ^{*14}	A	20
	Applicable earth leakage breaker capacity ^{*8}	A	20
	Maximum operating current	A	14 (For option -T:17)
	Rated operating current ^{*3} (50/60Hz)	A	7.9/9.6
	Rated power consumption ^{*3} (50/60Hz)	kVA	1.6/1.9
Noise level ^{*9} (50/60Hz)	dB	64 / 66	
Dimensions ^{*10}	mm	W377xD592xH676 (W14.8XD23.3xH26.6[Inch])	
Accessory		Fitting (for drain port) 1pc.,Sequence I/O command signal connector 1pc., Operation manual (Installation·Operation) 1pc., Alarm code list label 1pc., Ferrite core (For communication)	
Weight ^{*11}	kg	53	

- *1 Use the product in conditions where freezing will not occur.
- *2 Consult with SMC if using in a season or region where the ambient temperature will fall below zero.
- *3 If tap water is used, use water which satisfies the standard of The Japan Refrigeration And Air Conditioning Industry Association (JRA GL-02-1994/Cooling water system - circulation type - make-up water)
- *4 (1)Operating ambient temp.: 25 °C , (2)Circulating fluid temp.: 20 °C , (3)Circulating fluid rated flow, (4)Circulating fluid : Tap water, (5) Facility water temp.: 25°C(*16). The cooling capacity will be reduced by 300W when option T [High pressure pump] are selected.
- *5 Use a 15% ethylene glycol aqueous solution if operating in a place where the circulating fluid temp. is lower than 10 °C.
- *6 Outlet temp. when the circulating fluid flow is rated flow, and the circulating fluid outlet and the return are directly connected. Installation environment and power supply are within specification range and stable.
- *7 The capacity at the thermo-chiller outlet when the circulating fluid temp. is 20°C.
- *8 Fluid flow to maintain the cooling capacity and the temperature stability.
The specification of the cooling capacity and the temperature stability may not be satisfied if the flow rate is lower than the rated flow.
- *9 To be prepared by the customer. Use an earth leakage breaker with sensitivity of 30mA/200V in power supply specification.
- *10 Front 1m/Height 1m/Static with no load. See note 3 for other conditions.
- *11 Dimension between panels. Projection is not included.
- *12 Weight when the circulating fluid and facility water (for water-cooled type) is not included.
The weight will increase by 1kg when option J [Automatic fluid filling] is selected.
- *13 For option J [Automatic fluid filling port].
- *14 Copper, bronze and brass is not included when option M [DI water piping] is selected.
- *15 In case of option B [Earth leakage breaker], the breaker is changed to an earth leakage breaker.
- *16 This fitting is not included when option T [High pressure pump] are selected.
- *17 For water -cooled type.
- *18 There is required flow when adding load described on cooling capacity in case of note 3 conditions.

9.1.2 Refrigerant with GWP reference

Table9-2 Refrigerant with GWP reference

Refrigerant	Global Warming Potential (GWP)	
	Regulation (EU) No 517/2014 (Based on the IPCC AR4)	Revised Fluorocarbons Recovery and Destruction Law (Japanese law)
R134a	1,430	1,430
R404A	3,922	3,920
R407C	1,774	1,770
R410A	2,088	2,090

Note:

1. This product is hermetically sealed and contains fluorinated greenhouse gases.
2. See specification table for refrigerant used in the product.

9.1.3 Communication specifications

■ Contact input/output

Table 9-3 Specifications List

Item	Specification	
Connector type (for this product)	MC1,5/12-GF-3,5	
Input signal	Insulation system	Photo coupler
	Rated input Voltage	DC24V
	Operating voltage range	DC21.6V to 26.4V
	Rated input current	5mA TYP
	Input signal	4.7Ω
Contact output signal	Rated load current	AC48V or less /DC30V or less
	Maximum load current	AC/DC500mA (Resistance load)
	Minimum load current	DC5V 10mA
Output voltage	DC24V±10% 0.5A MAX	
Circuit structure diagram		

■ Serial communication

Table 9-4 Specifications List

Item	Specification	
Connector type (for this product)	D-sub9 pin Female connector	
Protocol	Modicon Modbus standard / Simple communication protocol	
Standard	EIA RS-485	EIA RS-232C
Circuit structure diagram		

9.2 Outline dimensions

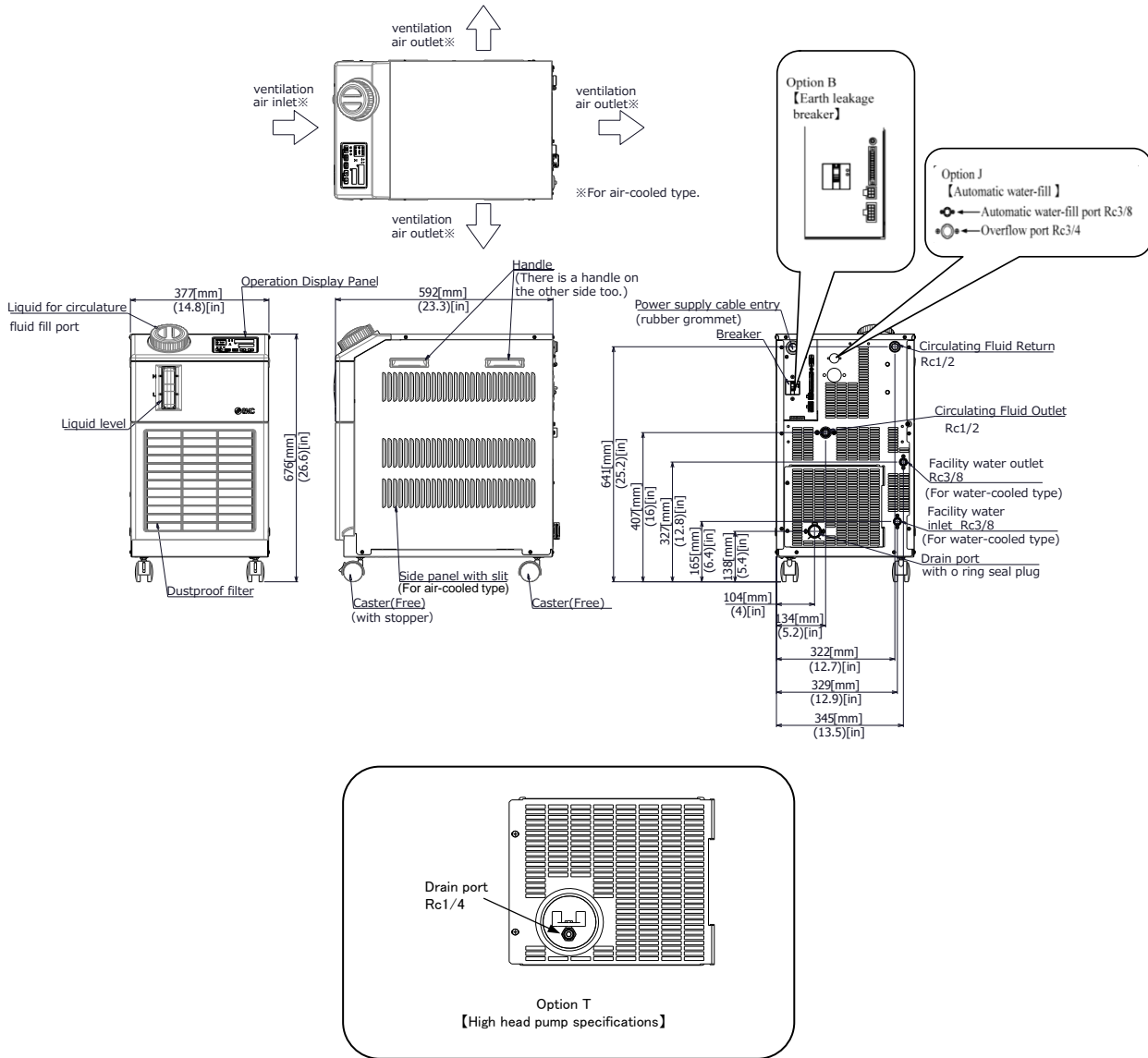

Fig. 9-1 Outline dimensions

9.3 Flow Chart

9.3.1 HRS040-A*-20-(BJMTW)

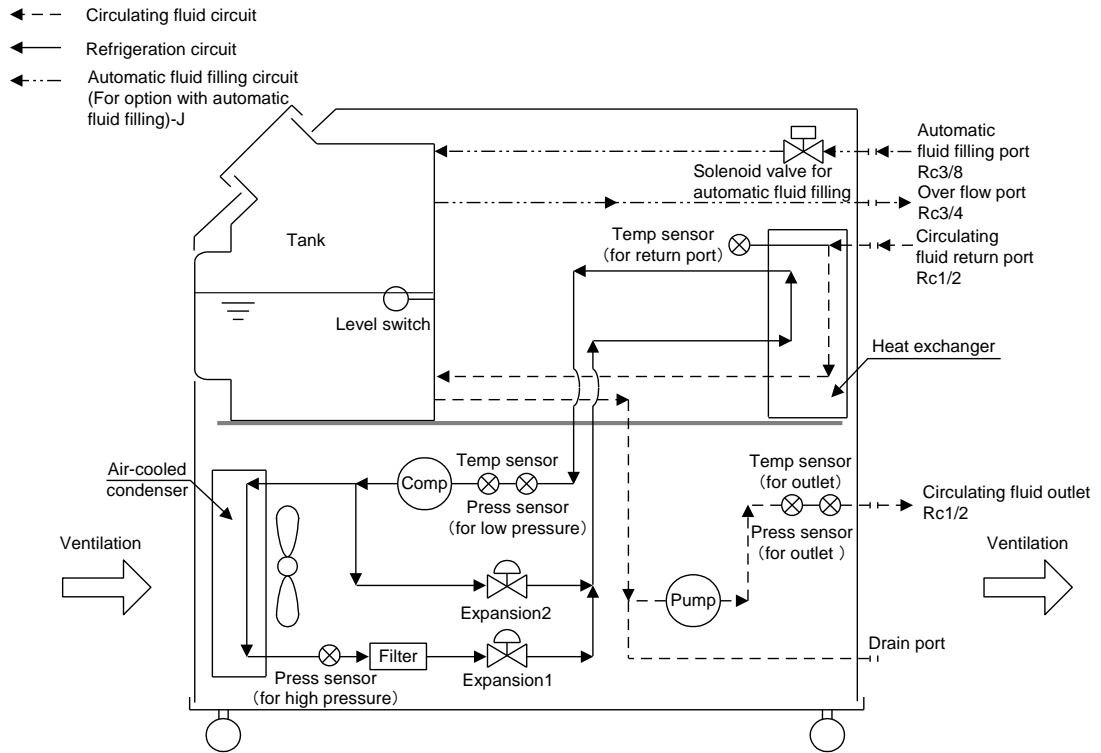

Fig. 9-2 Flow Chart(HRS040-A*-20-(BJMTW))

9.3.2 HRS040-W*-20-(BJMTW)

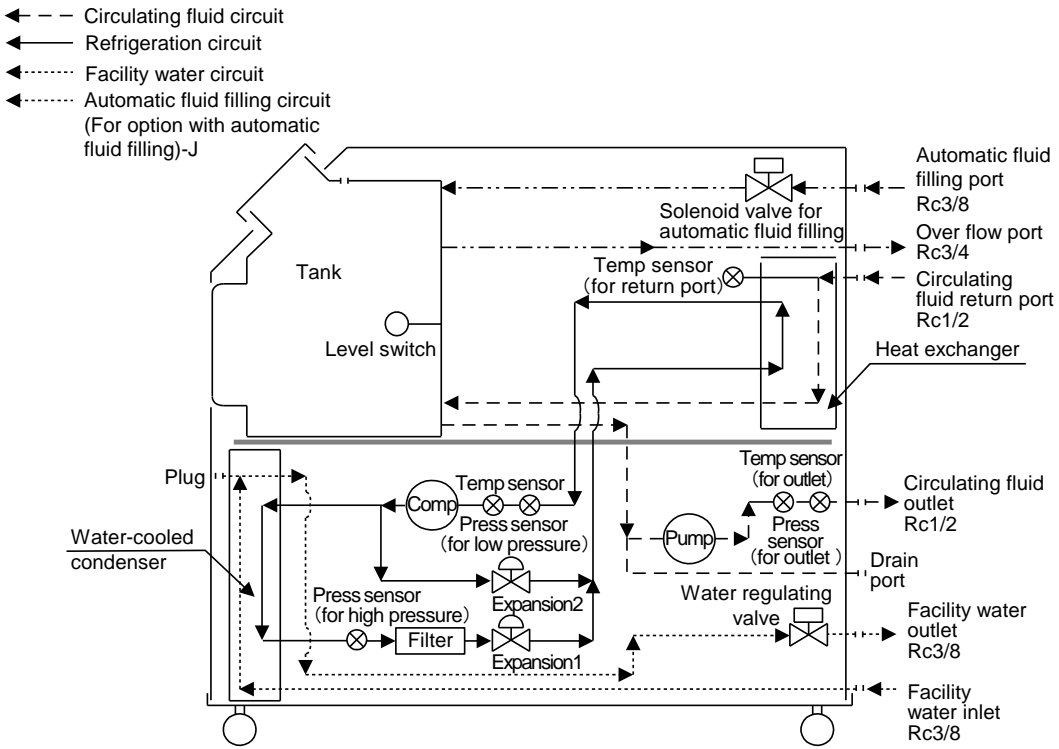
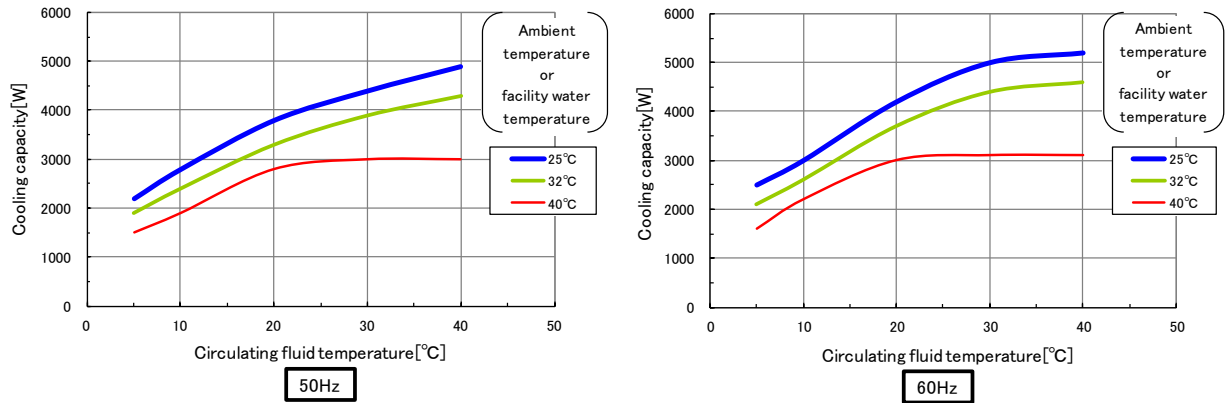

Fig. 9-3 Flow Chart(HRS040-W*-20-(BJMTW))

9.4 Cooling capacity

9.4.1 HRS040-**-20-(BJMTW)



*The cooling capacity will be reduced by 300W when option: -T and -MT are selected.

Fig. 9-4 Cooling capacity(HRS050-**-20-(BJMTW))

9.5 Heating capacity

9.5.1 HRS040-A-20-(BJMTW)

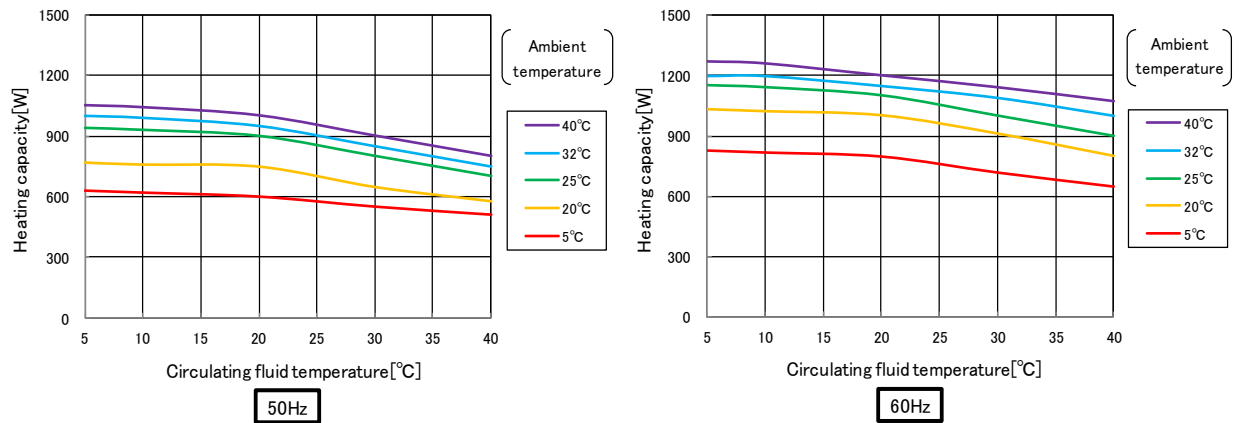

Fig. 9-5 Heating capacity(HRS050-A-20-(BJMTW))

9.5.2 HRS040-W-20-(BJMTW)

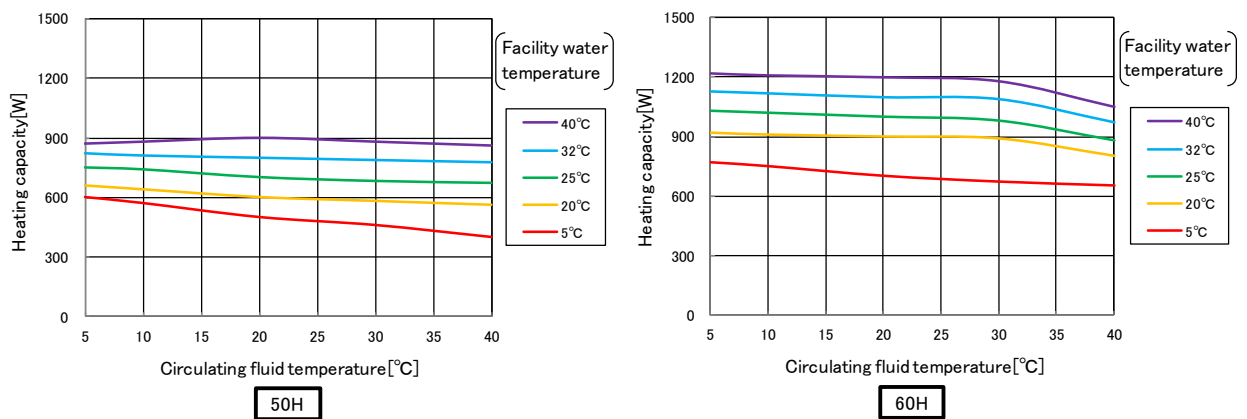

Fig. 9-6 Heating capacity(HRS050-W-20-(BJMTW))

9.6 Pump capacity

9.6.1 HRS040-**-20-(BJMW)

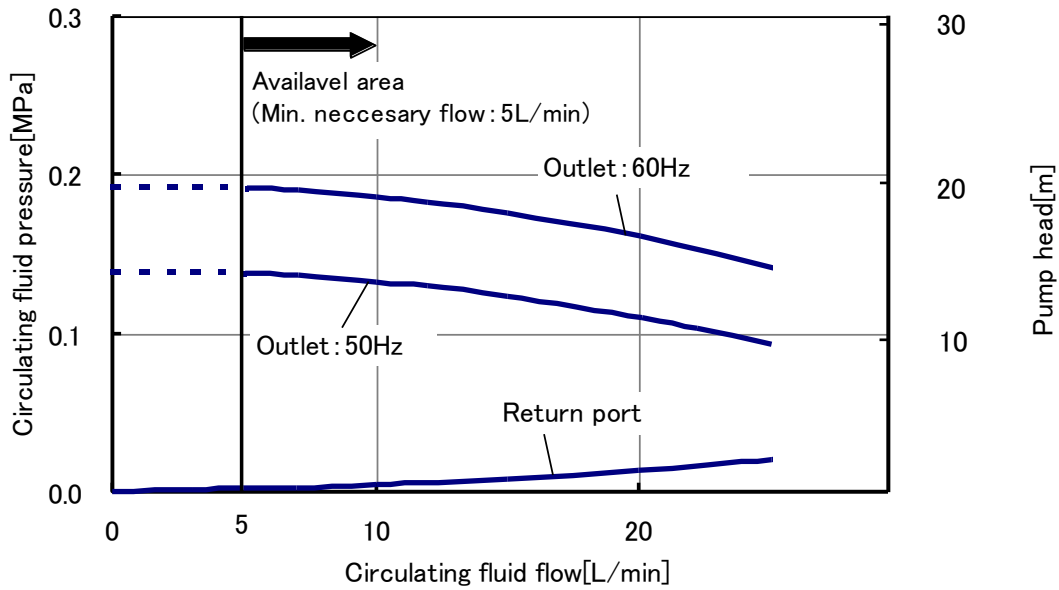

Fig. 9-7 Pump capacity(HRS040-**-20-(BJM))

9.6.2 HRS040-**-20-T,-MT

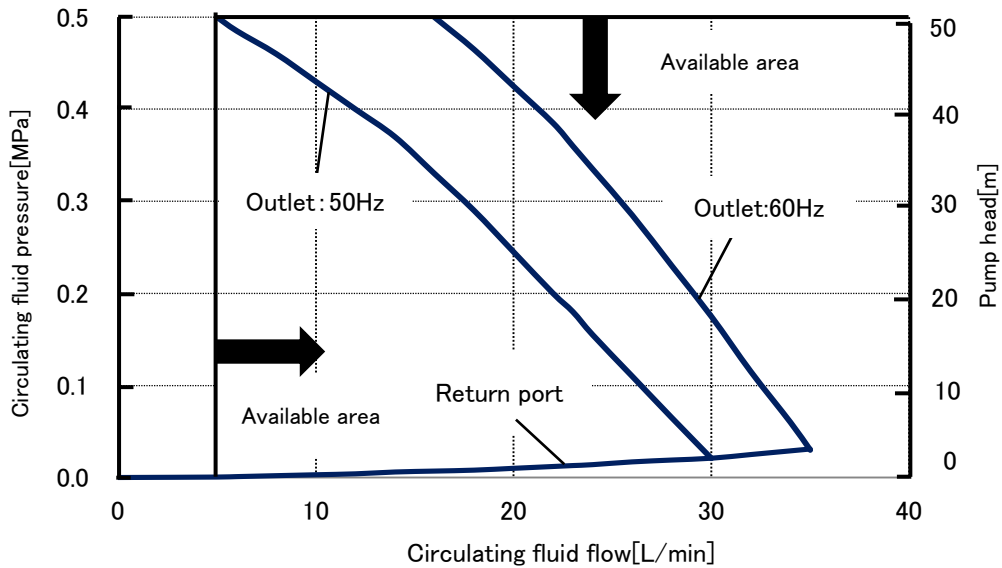
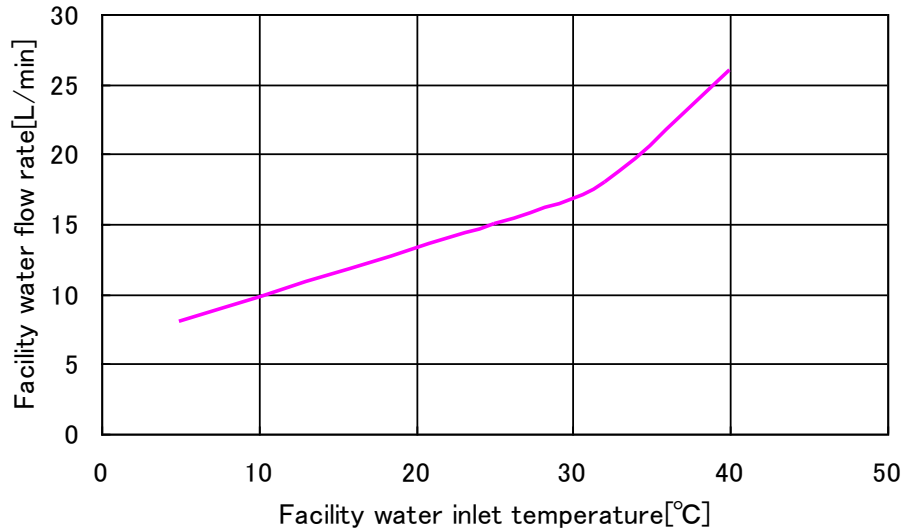

Fig. 9-8 Pump capacity(HRS040-**-20-T,-MT)

9.7 Required facility water flow (For water-cooled type)



* The amount of the facility water for the operation with rated circulating fluid, cooling capacity which is described in fig.9-4

Fig. 9-9 Required facility water flow (For water-cooled type)

9.8 Compliance

This system conforms to the following standards.

Table 9-5 Compliance

CE Marking	EMC Directive	2014/30/EU
	Machinery Directive	2006/42/EC
NRTL	E112803(UL61010-1)	

9.9 Sample DoC.



Sample DoC.

EC DECLARATION OF CONFORMITY

Original declaration

SMC Corporation

4-14-1 Soto-Kanda, Chiyoda-ku, Tokyo 101-0021 Japan

declares under our sole responsibility that the following equipment:

Thermo Chiller

HRS Series

Serial No.: *o001 to *Z999

conforms with the following directive(s) and harmonized standards:

Directive		Harmonized standards
Machinery Directive	2014/30/EU	EN ISO12100:2010 EN60204-1:2006+A1:2009
EMC Directive	2004/108/EC	EN61000-6-2:2005 EN55011:2009+A1:2010

Name and address of the person authorised to compile the technical file:

Mr. G. Berakoetxea, Director & General Manager, SMC European Zone,
 SMC España, S.A., Zuazobidea 14, 01015 Vitoria, Spain

Importer/Distributor in EU and EFTA:

Country	Company	Telephone	Address
Austria	SMC Pneumatik GmbH (Austria)	(43) 2262-62280-0	Girakstrasse 8, AT-2100 Korneuburg
Belgium	SMC Pneumatics N.V./S.A.	(32) 3-355-1464	Nijverheidsstraat 20, B-2160 Wommelgem
Bulgaria	SMC Industrial Automation Bulgaria EOOD	(359) 2 9744492	Business Park Sofia, Building 8-6th Floor, BG-1715 Sofia
Czech Republic	SMC Industrial Automation CZ s.r.o.	(420) 541-426-611	Hudcova 78a CZ-61200 Brno
Denmark	SMC Pneumatik A/S	(45) 70 25 29 00	Egeskovvej 1, DK-8700 Horsens
Estonia	SMC Pneumatics Estonia OÜ	(372)651-0370	Laki 12, EE-10621 Tallinn
Finland	SMC Pneumatikka Finland Oy	(358) 20 7513 513	PL72, Tiistiniityntie 4, SF-02231 Espoo
France	SMC Pneumatique S.A.	(33) 1-6476-1000	1 Boulevard de Strasbourg, Parc Gustave Eiffel, Bussy Saint Georges, F-77600
Germany	SMC Pneumatik GmbH	(49) 6103-402-0	Boschring 13-15, D-63329 Egelsbach
Greece	SMC Hellas E.P.E	(30) 210-2717265	Anageniseos 7-9 - P.C. 14342, Nea Philadelphia, Athens
Hungary	SMC Hungary Ipari Automatizálási Kft.	(36) 23-511-390	Torbágy u. 19, HU-2045 Törökbálint
Ireland	SMC Pneumatics (Ireland) Ltd.	(353) 1-403-9000	2002 Citywest Business Campus, Naas Road, Saggart, Co. Dublin
Italy	SMC Italia S.p.A.	(39) 02-9271-1	Via Garibaldi, 62, I-20061 Carugate, Milano
Latvia	SMC Pneumatics Latvia SIA	(371)781-77-00	Šmerļa ielā, 1-705, Rīga LV-1006
Lithuania	SMC Pneumatics Lietuva,UAB	(370)5-264-81-26	Oslo g.1, LT-04123 Vilnius
Netherlands	SMC Pneumatics B.V.	(31) 20-531-8888	De Ruyterkade 120, NL-1011 AB Amsterdam
Norway	SMC Pneumatics Norway AS	(47) 67-12-90-20	Vollsveien 13c, Granfoss Næringspark, N-1366 Lysaker
Poland	SMC Industrial Automation Polska Sp. zo.o	(48) 22 211 96 00	ul. Poloneza 89, PL-02-826 Warszawa
Portugal	SMC Sucursal Portugal, S.A.	(351) 22 616 6570	Rua De Eng Ferrerira Dias 452 4100-246,Porto
Romania	SMC Romania S.r.l.	(40)21-3205111	Str. Frunzei, Nr.29, Sector 2 Bucharest, Romania
Slovakia	SMC Priemyselna Automatizacia, s.r.o.	(421) 2-444 56 725	Námestie Matina Benku, 10, 81107 Bratislava
Slovenia	SMC Industrijska Avtomatika d.o.o.	(386) 7388 5412	Mirnska cesta 7, SLO-8210 Trebnje
Spain	SMC España, S.A.	(34) 945-184-100	Zuazobidea 14, 01015 Vitoria
Sweden	SMC Pneumatics Sweden AB	(46) 8-603-12-00	Ekhagsvägen 29-31, SE-14171 Segeltorp
Switzerland	SMC Pneumatik AG	(41) 52-396-3131	Dorfstrasse 7, Postfach 117 CH-8484, Weisslingen
United Kingdom	SMC Pneumatics (U.K.) Ltd.	(44) 1908-563888	Vincent Avenue, Crownhill, Milton Keynes, Bucks MK8 0AN

Tokyo, * th January 20 * *

Iwao Mogi

Director & General Manager

Product Development Division - VI

Chapter 10 Product Warranty

1. Period

The warranty period of the product is 1 year in service or 1.5 years after the product is delivered, whichever is first.

2. Scope

For any failure reported within the warranty period which is clearly our responsibility, replacement parts will be provided. In that case, removed parts shall become the property of SMC. This guarantee applies only to our product independently, and not to any other damage incurred due to the failure of the product.

3. Content

1. We guarantee that the product will operate normally if it is installed under maintenance and control in accordance with the Operation Manual, and operated under the conditions specified in the catalog or contracted separately.
2. We guarantee that the product does not have any defects in components, materials or assembly.
3. We guarantee that the product complies with the outline dimensions provided.
4. The following situations are out of scope of this warranty.
 - (1) The product was incorrectly installed or connected with other equipment.
 - (2) The product was under insufficient maintenance and control or incorrectly handled.
 - (3) The product was operated outside of the specifications.
 - (4) The product was modified or altered in construction.
 - (5) The failure was a secondary failure of the product caused by the failure of equipment connected to the product.
 - (6) The failure was caused by a natural disaster such as an earthquake, typhoon, or flood, or by an accident or fire.
 - (7) The failure was caused by operation different from that shown in the Operation Manual or outside of the specifications.
 - (8) The checks and maintenance specified (daily checks and regular checks) were not performed.
 - (9) The failure was caused by the use of circulating fluid or facility water other than those specified.
 - (10) The failure occurred naturally over time (such as discoloration of a painted or plated face).
 - (11) The failure does not affect the functioning of the product (such as new sounds, noises and vibrations).
 - (12) The failure was due to the "Installation Environment" specified in the Operation Manual.
 - (13) The failure was caused by the customer disregarding "6. Request to customers".

4. Agreement

If there is any doubt about anything specified in "2. Scope" and "3. Content", it shall be resolved by agreement between the customer and SMC.

5. Disclaimer

- (1) Expenses for daily and regular checks
- (2) Expenses for repairs performed by other companies
- (3) Expenses for transfer, installation and removal of the product
- (4) Expenses for replacement of parts other than those in this product, or for the supply of liquids
- (5) Inconvenience and loss due to product failure (such as telephone bills, compensation for workplace closure, and commercial losses)
- (6) Expenses and compensation not covered in "2. Scope".

6. Request to customers

Proper use and maintenance are essential to assure safe use of this product. Be sure to satisfy the following preconditions. Please note that we may refuse to carry out warranted repair if these preconditions have been disregarded.

- (1) Use the product following the instructions for handling described in the Operation Manual.
- (2) Perform checks and maintenance (daily checks and regular checks) specified in the Operation Manual and Maintenance Manual.
- (3) Record the check and maintenance results on the daily check sheet attached to the Operation Manual and Maintenance Manual.

7. Request for Warranted Repair

For warranted repair, please contact the supplier you purchased this product from. Warranted repair shall be on a request basis.

Repair shall be provided free of charge in accordance with the warranty period, preconditions and terms defined above. Therefore, a fee will be charged for any repairs if a failure is detected after the end of the warranty period.

Revision
Rev.B : Oct. 2019

SMC Corporation

4-14-1, Sotokanda, Chiyoda-ku, Tokyo 101-0021 JAPAN

Tel: + 81 3 5207 8249 Fax: +81 3 5298 5362

URL <http://www.smcworld.com>

Note: Specifications are subject to change without prior notice and any obligation on the part of the manufacturer.

© 2019 SMC Corporation All Rights Reserved