



Operation Manual

PRODUCT NAME

EtherNet/IP™ SI unit

MODEL / Series / Product Number

UIUSP-SEN#-DUO02979

SMC Corporation



Contents

Safety Instructions	2
How to Order	7
Summary of Product elements	8
Installation and Cabling	9
General instructions on installation	9
Connecting cables	10
LED indication and Settings	13
Troubleshooting and Maintenance	19
Specifications	23
Table of Specifications	23
Dimensions	25
Accessories	26

Safety Instructions

These safety instructions are intended to prevent hazardous situations and/or equipment damage. These instructions indicate the level of potential hazard with the labels of "Caution", "Warning" or "Danger". They are all important notes for safety and must be followed in addition to International standards (ISO/IEC), and other safety regulations.

- *1) ISO 4414: Pneumatic fluid power - - General rules relating to systems.
- ISO 4413: Hydraulic fluid power - - General rules relating to systems.
- IEC 60204-1: Safety of machinery - -Electrical equipment of machines. (Part 1: General requirements)
- ISO 10218-1992: Manipulating industrial robots -Safety.
- etc.

 Caution :	CAUTION indicates a hazard with a low level of risk which, if not avoided, could result in minor or moderate injury.
 Warning :	WARNING indicates a hazard with a medium level of risk which, if not avoided, could result in death or serious injury.
 Danger :	DANGER indicates a hazard with a high level of risk which, if not avoided, will result in death or serious injury.

Warning

1. The compatibility of the product is the responsibility of the person who designs the equipment or decides its specifications.

Since the product specified here is used under various operating conditions, its compatibility with specific equipment must be decided by the person who designs the equipment or decides its specifications based on necessary analysis and test results. The expected performance and safety assurance of the equipment will be the responsibility of the person who has determined its compatibility with the product. This person should also continuously review all specifications of the product referring to its latest catalog information, with a view to giving due consideration to any possibility of equipment failure when configuring the equipment.

2. Only personnel with appropriate training should operate machinery and equipment.

The product specified here may become unsafe if handled incorrectly. The assembly, operation and maintenance of machines or equipment including our products must be performed by an operator who is appropriately trained and experienced.

3. Do not service or attempt to remove product and machinery/equipment until safety is confirmed.

1. The inspection and maintenance of machinery/equipment should only be performed after measures to prevent falling or runaway of the driven objects have been confirmed.
2. When the product is to be removed, confirm that the safety measures as mentioned above are implemented and the power from any appropriate source is cut, and read and understand the specific product precautions of all relevant products carefully.
3. Before machinery/equipment is restarted, take measures to prevent unexpected operation and malfunction.

4. Contact SMC beforehand and take special consideration of safety measures if the product is to be used in any of the following conditions.

1. Conditions and environments outside of the given specifications, or use outdoors or in a place exposed to direct sunlight.
2. Installation on equipment in conjunction with atomic energy, railways, air navigation, space, shipping, vehicles, military, medical treatment, combustion and recreation, or equipment in contact with food and beverages, emergency stop circuits, clutch and brake circuits in press applications, safety equipment or other applications unsuitable for the standard specifications described in the product catalog.
3. An application which could have negative effects on people, property, or animals requiring special safety analysis.
4. Use in an interlock circuit, which requires the provision of double interlock for possible failure by using a mechanical protective function, and periodical checks to confirm proper operation.

Caution

The product is provided for use in manufacturing industries.

The product herein described is basically provided for peaceful use in manufacturing industries. If considering using the product in other industries consult SMC beforehand and exchange specifications or a contract if necessary.
If anything is unclear, contact your nearest sales branch.

Limited warranty and Disclaimer/Compliance Requirements

The product used is subject to the following "Limited warranty and Disclaimer" and "Compliance Requirements".

Read and accept them before using the product.

Limited warranty and Disclaimer

1. The warranty period of the product is 1 year in service or 1.5 years after the product is delivered. ^{*1)}
Also, the product may have specified durability, running distance or replacement parts. Please consult your nearest sales branch.
2. For any failure or damage reported within the warranty period which is clearly our responsibility, a replacement product or necessary parts will be provided.
This limited warranty applies only to our product independently, and not to any other damage incurred due to the failure of the product.
3. Prior to using SMC products, please read and understand the warranty terms and disclaimers noted in the specified catalog for the particular products.

*1) Vacuum pads are excluded from this 1 year warranty.

A vacuum pad is a consumable part, so it is warranted for a year after it is delivered.

Also, even within the warranty period, the wear of a product due to the use of the vacuum pad or failure due to the deterioration of rubber material are not covered by the limited warranty.

Compliance Requirements

When the product is exported, strictly follow the laws required by the Ministry of Economy, Trade and Industry (Foreign Exchange and Foreign Trade Control Law).

Operator

- ◆ This operation manual has been written for those who have knowledge of machinery and apparatus that use pneumatic equipment and have full knowledge of assembly, operation and maintenance of such equipment.
- ◆ Please read this operation manual carefully and understand it before assembling, operating or providing maintenance to the product.

■ Safety Instructions



Warning

- Do not disassemble, modify (including changing the printed circuit board) or repair.
An injury or failure can result.
- Do not operate the product outside of the specifications.
Do not use for flammable or harmful fluids.
Fire, malfunction, or damage to the product can result.
Verify the specifications before use.
- Do not operate in an atmosphere containing flammable or explosive gases.
Fire or an explosion can result.
This product is not designed to be explosion proof.
- If using the product in an interlocking circuit:
 - Provide a double interlocking system, for example a mechanical system.
 - Check the product regularly for proper operation.Otherwise malfunction can result, causing an accident.
- The following instructions must be followed during maintenance:
 - Turn off the power supply.
 - Stop the air supply, exhaust the residual pressure and verify that the air is released before performing maintenance.Otherwise an injury can result.

Caution

- After maintenance is complete, perform appropriate functional inspections.
Stop operation if the equipment does not function properly.
Safety cannot be assured in the case of unexpected malfunction.
- Provide grounding to assure the safety and noise resistance of the Serial System.
Individual grounding should be provided close to the product with a short cable.

■NOTE

- Follow the instructions given below when designing, selecting and handling the product.
 - The instructions on design and selection (installation, wiring, environment, adjustment, operation, maintenance, etc.) described below must also be followed.
 - Product specifications
 - When conformity to UL is necessary the SI unit must be used with a UL1310 Class2 power supply.
 - The SI unit is a  approved product only if they have a  mark on the body.
 - Use the specified voltage.
 - Otherwise failure or malfunction can result.
 - Reserve a space for maintenance.
 - Allow sufficient space for maintenance when designing the system.
 - Do not remove any nameplates or labels.
 - This can lead to incorrect maintenance, or misreading of the operation manual, which could cause damage or malfunction to the product.
 - It may also result in non-conformity to safety standards.
- Product handling
 - Installation
 - Do not drop, hit or apply excessive shock to the fieldbus system.
 - Otherwise damage to the product can result, causing malfunction.
 - Tighten to the specified tightening torque.
 - If the tightening torque is exceeded the mounting screws may be broken.
 - IP67 protection cannot be guaranteed if the screws are not tightened to the specified torque.
 - Never mount a product in a location that will be used as a foothold.
 - The product may be damaged if excessive force is applied by stepping or climbing onto it.
 - Wiring
 - Avoid repeatedly bending or stretching the cables, or placing heavy load on them.
 - Repetitive bending stress or tensile stress can cause breakage of the cable.
 - Wire correctly.
 - Incorrect wiring can break the product.
 - Do not perform wiring while the power is on.
 - Otherwise damage to the fieldbus system and/or I/O device can result, causing malfunction.
 - Do not route wires and cables together with power or high voltage cables.
 - Otherwise the fieldbus system and/or I/O device can malfunction due to interference of noise and surge voltage from power and high voltage cables to the signal line.
 - Route the wires (piping) of the fieldbus system and/or I/O device separately from power or high voltage cables.
 - Confirm proper insulation of wiring.
 - Poor insulation (interference from another circuit, poor insulation between terminals, etc.) can lead to excess voltage or current being applied to the product, causing damage.
 - Take appropriate measures against noise, such as using a noise filter, when the fieldbus system is incorporated into equipment.
 - Otherwise noise can cause malfunction.

Environment

- Select the proper type of protection according to the environment of operation.
IP67 protection is achieved when the following conditions are met.
 - (1) The units are connected properly with fieldbus cable with M12 connector and power cable with M12 (M8) connector.
 - (2) Suitable mounting of each unit and manifold valve.If using in an environment that is exposed to water splashes, please take measures such as using a cover.
 - Do not use in a place where the product could be splashed by oil or chemicals.
If the product is to be used in an environment containing oils or chemicals such as coolant or cleaning solvent, even for a short time, it may be adversely affected (damage, malfunction etc.).
 - Do not use the product in an environment where corrosive gases or fluids could be splashed.
Otherwise damage to the product and malfunction can result.
 - Do not use in an area where surges are generated.
If there is equipment which generates a large amount of surge (solenoid type lifter, high frequency induction furnace, motor, etc.) close to the fieldbus system, this may cause deterioration or breakage of the internal circuit of the fieldbus system. Avoid sources of surge generation and crossed lines.
 - When a surge-generating load such as a relay or solenoid is driven directly, use a fieldbus system with a built-in surge absorbing element.
Direct drive of a load generating surge voltage can damage the fieldbus system.
 - The product is CE marked, but not immune to lightning strikes. Take measures against lightning strikes in the system.
 - Prevent foreign matter such as remnant of wires from entering the fieldbus system to avoid failure and malfunction.
 - Mount the product in a place that is not exposed to vibration or impact.
Otherwise failure or malfunction can result.
 - Do not use the product in an environment that is exposed to temperature cycle.
Heat cycles other than ordinary changes in temperature can adversely affect the inside of the product.
 - Do not expose the product to direct sunlight.
If using in a location directly exposed to sunlight, shade the product from the sunlight.
Otherwise failure or malfunction can result.
 - Keep within the specified ambient temperature range.
Otherwise malfunction can result.
 - Do not operate close to a heat source, or in a location exposed to radiant heat.
Otherwise malfunction can result.
- Adjustment and Operation
- Perform settings suitable for the operating conditions.
Incorrect setting can cause operation failure.
 - Please refer to the PLC manufacturer's manual etc. for details of programming and addresses.
For the PLC protocol and programming refer to the relevant manufacturer's documentation.
- Maintenance
- Turn off the power supply, stop the supplied air, exhaust the residual pressure and verify the release of air before performing maintenance.
There is a risk of unexpected malfunction.
 - Perform regular maintenance and inspections.
There is a risk of unexpected malfunction.
 - After maintenance is complete, perform appropriate functional inspections.
Stop operation if the equipment does not function properly.
Otherwise safety is not assured due to an unexpected malfunction or incorrect operation.
 - Do not use solvents such as benzene, thinner etc. to clean the each unit.
They could damage the surface of the body and erase the markings on the body.
Use a soft cloth to remove stains.
For heavy stains, use a cloth soaked with diluted neutral detergent and fully squeezed, then wipe up the stains again with a dry cloth.

How to Order

UIUSP-SEN#-DUO02979

Connector type, output specification

1	M12 connector, 32 outputs, PNP (negative common)
2	M12 connector, 32 outputs, NPN (positive common)

Fieldbus

EN	EtherNet/IP™
----	--------------

Compatible Solenoid Valve

1. VQC1000/2000/4000
2. SV1000/2000/3000
3. SY3000/5000
4. S0700

Note 1: When ordering the above UIUSP-SEN#-DUO02979 module with VQC4000 series valve manifold, use EX260 SI unit's how to order manifold document. Do not use EX250 how to order manifold document.

Note 2: When ordering the VQC4000 manifold without the above SI module, use EX260 how to order manifold document. For example VV5QC41-16C8SD0 manifold is compatible with the UIUSP-SEN#-DUO02979 SI unit. Refer to the screen shot.

Note 3: For UIUSP-SEN1-DUO02979, use negative common valve and for UIUSP-SEN2-DUO02979 use positive common valve.

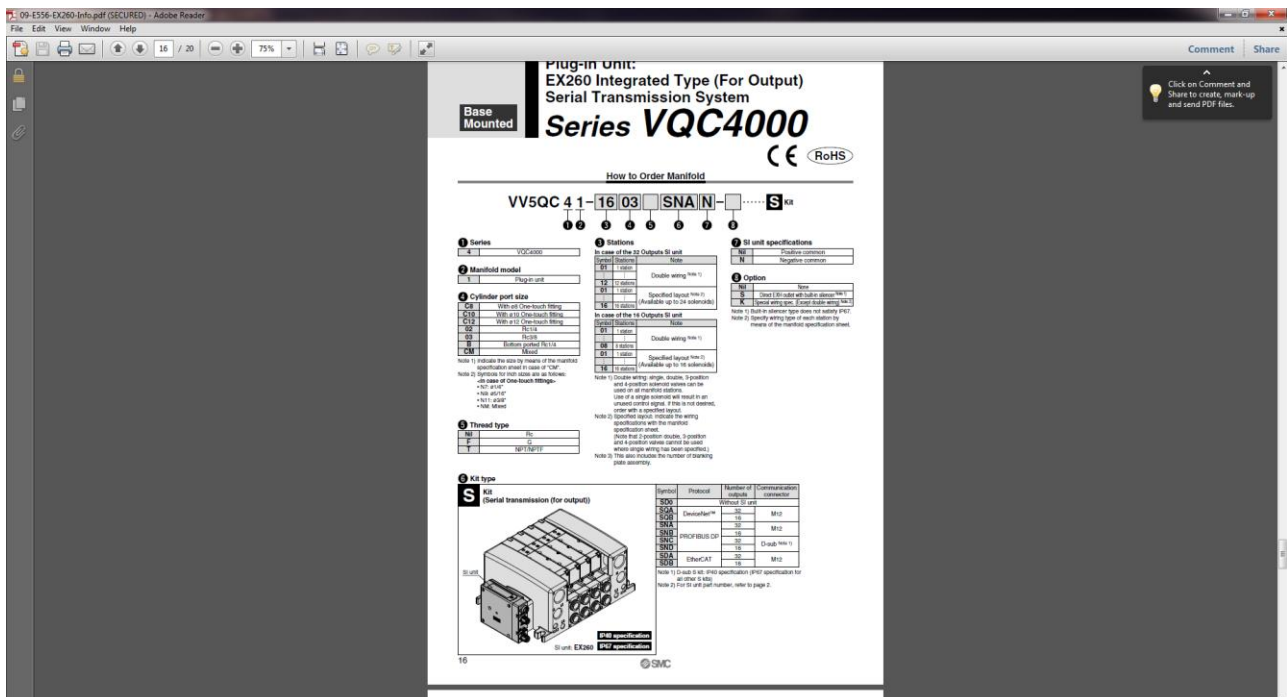

Summary of Product elements

< UIUSP-SEN#-DUO02979 >

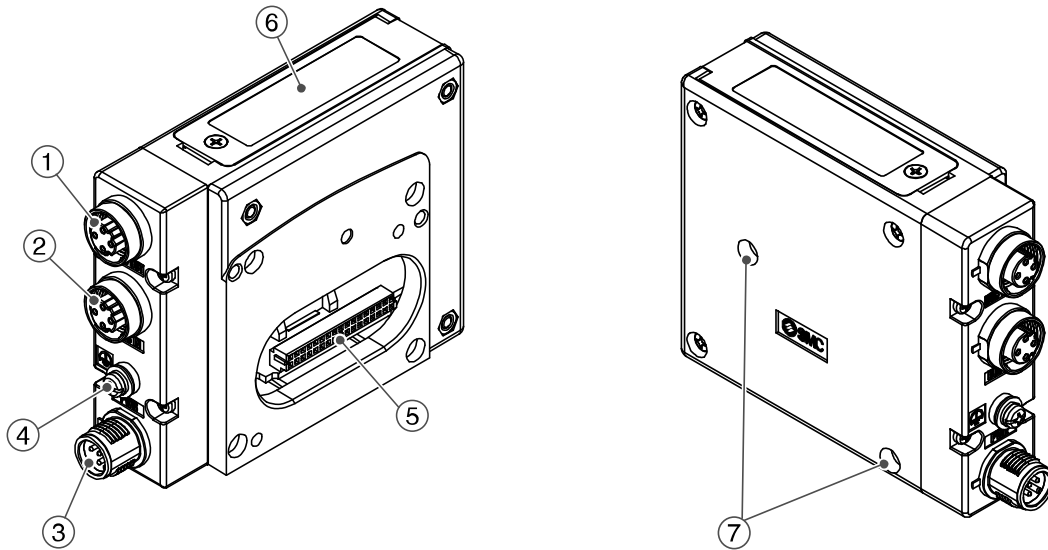

No.	Element	Description
1	Fieldbus interface connector (BUS OUT)	Ethernet connection (M12, 4-pin socket, D-coded) * ¹
2	Fieldbus interface connector (BUS IN)	Ethernet connection (M12, 4-pin socket, D-coded) * ¹
3	Power supply connector	Power supply with load voltage for valves and operating voltage for SI unit * ¹ (M12 5-pin plug, A-coded)
4	Ground terminal	Functional earth (M3 screw)
5	Output connector	Output signal interface for valve manifold
6	LED Display window	Network status specific and SI unit specific LEDs * ²
7	Mounting hole	Mounting hole for connection to the valve manifold

Accessories

Hexagon socket head cap screw	2pcs. M3x30 screw for connection to the valve manifold
Seal cap	1pc. seal cap for unused fieldbus interface connector (BUS OUT)

*1: Refer to page 36 for connecting cables.

*2: Refer to page 13 for the LED indication.

Installation and Cabling

■ Installation

Connect valve manifold to the SI unit.

- Dimensions for installation

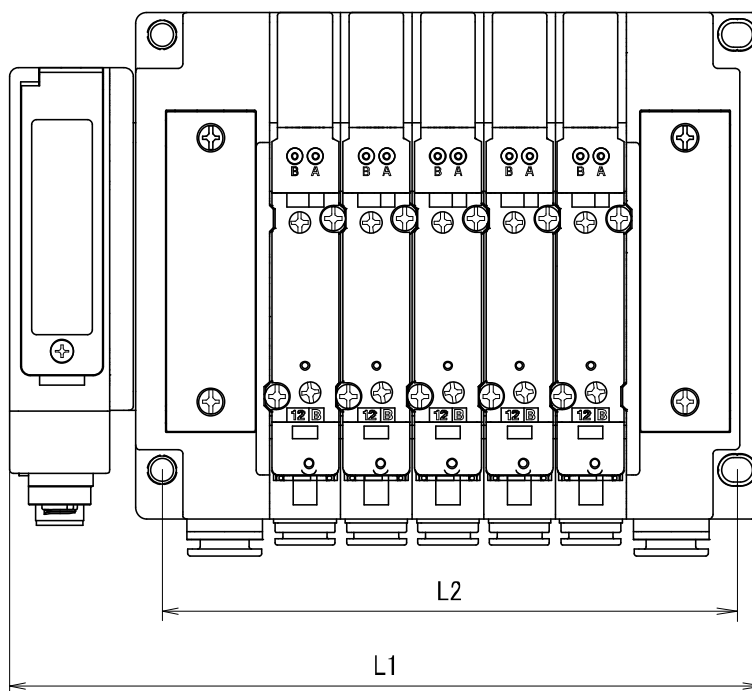

n: number of valve stations

L \ n	1	2	3	4	5	6	7	8
L1		120.7	136.7	152.7	168.7	184.7	200.7	216.7
L2		80	96	112	128	144	160	176
L \ n	9	10	11	12	13	14	15	16
L1	232.7	248.7	264.7	280.7	296.7	312.7	328.7	344.7
L2	192	208	224	240	256	272	288	304

(mm)

The above table shows dimensions as an example for the SY5000 series valve manifold.
 Connectable valve manifolds are the same as for EX260 series SI unit.
 Refer to the EX260 series valve manifold section in the valve catalog for valve manifold dimensions.

■ Connecting cables

Select the appropriate cables to mate with the connectors mounted on the SI unit.

Fieldbus interface connector layout

BUS OUT: M12 4-pin socket D-coded

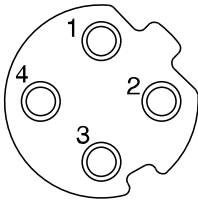

No.	Designation	Description
1	TD+	Transmit Data +
2	RD+	Receive Data +
3	TD-	Transmit Data -
4	RD-	Receive Data -

BUS IN: M12 4-pin socket D-coded

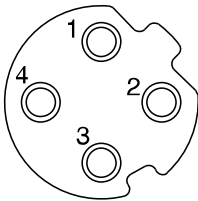

No.	Designation	Description
1	TD+	Transmit Data +
2	RD+	Receive Data +
3	TD-	Transmit Data -
4	RD-	Receive Data -

Connect the “BUS IN or BUS OUT” connector to the upstream device (PC, PLC etc.) and connect the “BUS IN or BUS OUT” connector to the downstream device.

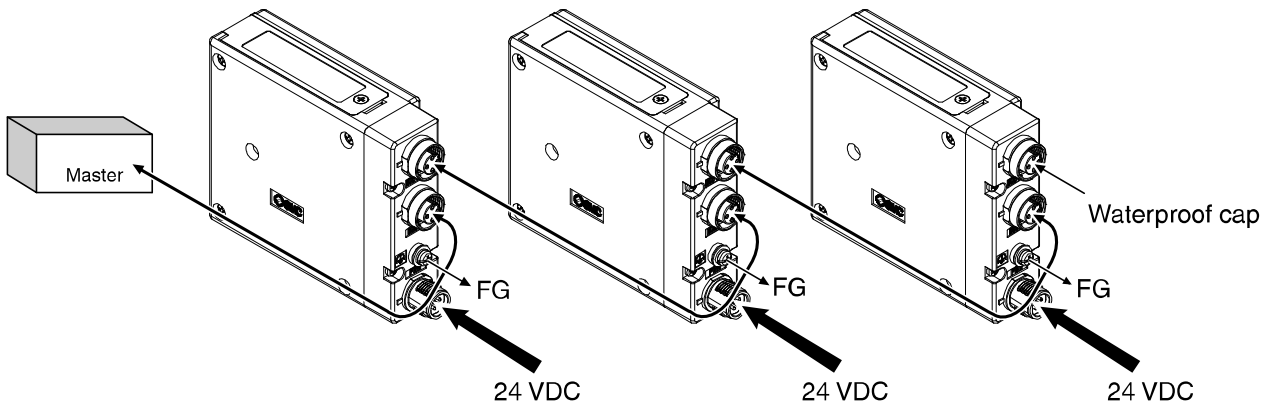

Note

Be sure to use a seal cap on any unused connectors.

Proper use of the seal cap enables the enclosure to achieve IP67 specification.

*1: Refer to page 27 for the seal cap.

Power supply connector layout

PWR: M12 5-pin Plug A-coded

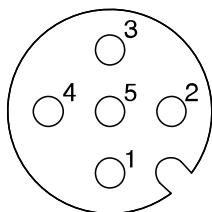

No.	Designation	Description
1	SV 24V	+24 V for solenoid valve
2	SV 0V	0 V for solenoid valve
3	SI 24V	+24 V for SI unit operation
4	SI 0V	0 V for SI unit operation
5	-	Unused

Power-supply line for solenoid valve and power-supply line for SI unit operation are isolated. Be sure to supply power, respectively. Either single-source power or two different power supplies can be used.

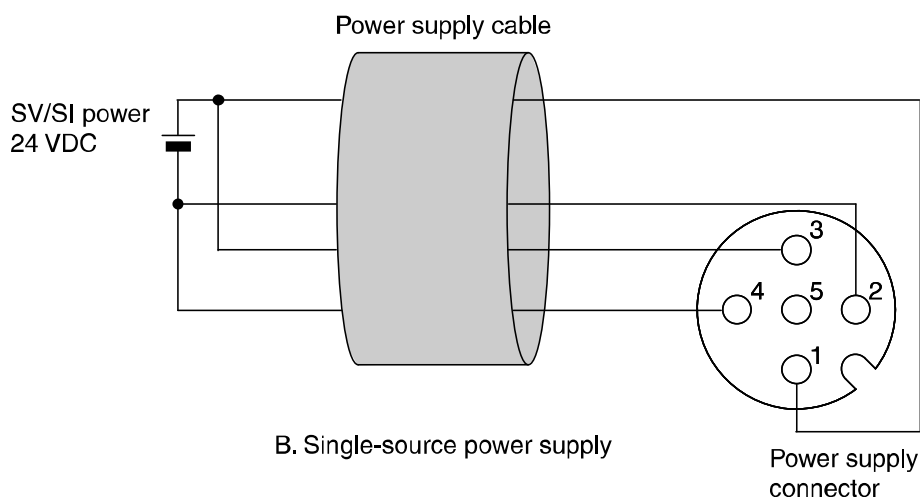
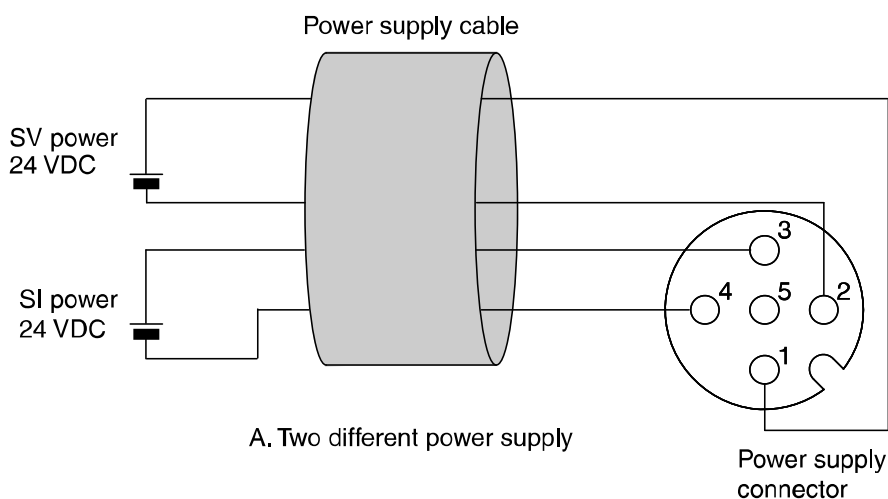

Note) Pay attention not to exceed the tolerance range of power supply voltage.

Ground terminal

Connect the ground terminal to ground.
Resistance to ground should be 100 ohms or less.

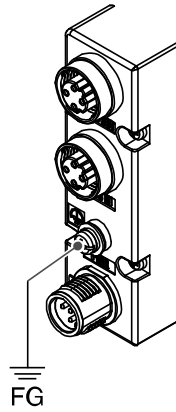

LED indication and Settings

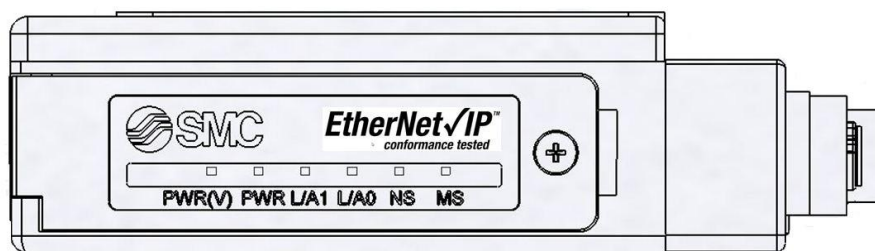

■LED indication

LED	LED Status	Description
MS	<input checked="" type="checkbox"/> Green ON	No Module Fault. Normal Operation.
	<input checked="" type="checkbox"/> Red Flashing	Recoverable Module Fault.
	<input checked="" type="checkbox"/> Green Flashing	Module not configured yet.
	<input checked="" type="checkbox"/> Red ON	Unrecoverable Module Fault.
	<input type="checkbox"/> OFF	No Module power.
NS	<input checked="" type="checkbox"/> Green ON	No Network Fault. Connection established.
	<input checked="" type="checkbox"/> Green Flashing	An IP address is configured, but no CIP connections are established,
	<input checked="" type="checkbox"/> RED Flashing	Network Fault or connection not established.
	<input checked="" type="checkbox"/> RED ON	Duplicate IP address.
	<input type="checkbox"/> OFF	No module power or the IP address not assigned.
L/A 0	<input type="checkbox"/> OFF	BUS IN side: No Link, No Activity.
	<input checked="" type="checkbox"/> Green ON	BUS IN side: Link
	<input checked="" type="checkbox"/> Yellow ON	Activity
L/A 1	<input type="checkbox"/> OFF	BUS OUT side: No Link, No Activity.
	<input checked="" type="checkbox"/> Green ON	BUS OUT side: Link
	<input checked="" type="checkbox"/> Yellow ON	Activity
PWR	<input checked="" type="checkbox"/> Green ON	SI unit operating voltage is supplied.
	<input type="checkbox"/> OFF	SI unit operating voltage is not supplied.
PWR(V)	<input checked="" type="checkbox"/> Green ON	Load voltage for the valve is supplied.
	<input type="checkbox"/> OFF	Load voltage for the valve is not supplied or out side the tolerance range (*1).

*1: PWR(V) LED turns OFF if the supplied voltage is less than 21.4VDC or more than 26.4VDC.

Commissioning

■ Configuration in ControlLogix PLC

In order to configure the module with EtherNet/IP master's software, the appropriate EDS file is required only if the user would like to see the graphic of the module in RSLinx. EDS file is not required to configure the module in RSLogix5000. RSNetworkx for EtherNet is also not required to configure the module but it is required to register the EDS file.

To configure the module using Allen Bradley ControlLogix PLC, the following software's are required.

1. RSLinx For establishing a connection between PC, PLC and the SMC module(s).
2. BootP Utility For assigning IP address to SMC module(s)
3. RSLogix5000 For configuration and programming of SMC module(s).
4. RSNetworkx for EtherNet (Note: This software is needed to register the eds file. The graphics of the module will show up in RSLinx once the EDS file is registered and an icon file is attached with it)

Connection with Rockwell's ControlLogix PLC

1. Launch RSLogix5000

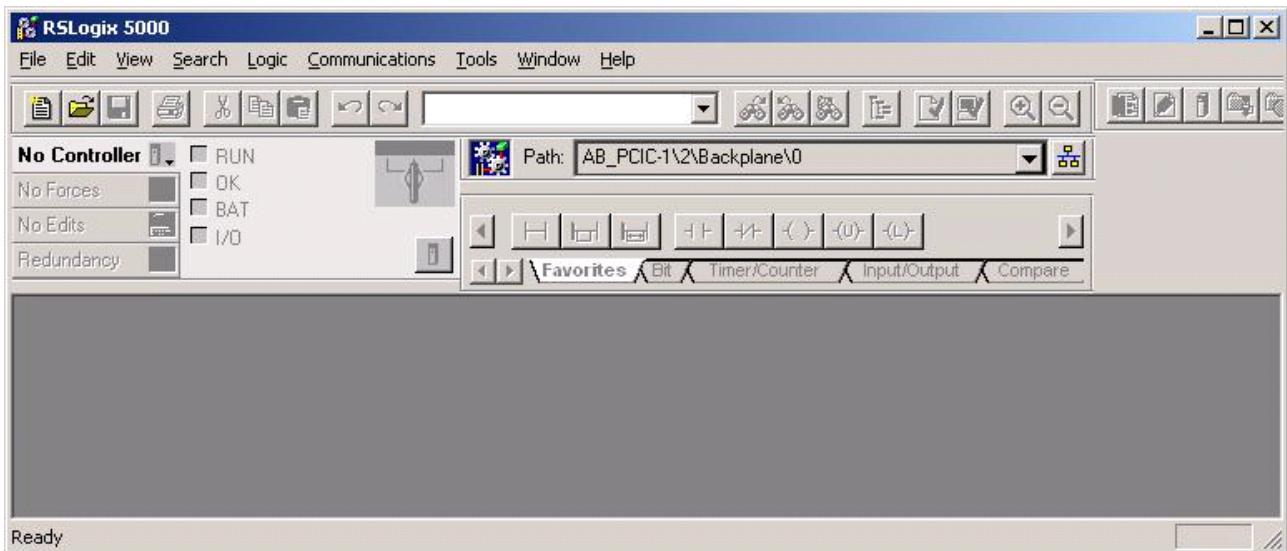

2. From the file menu select new and enter all of the parameters according to your software and the PLC platform. Click OK.

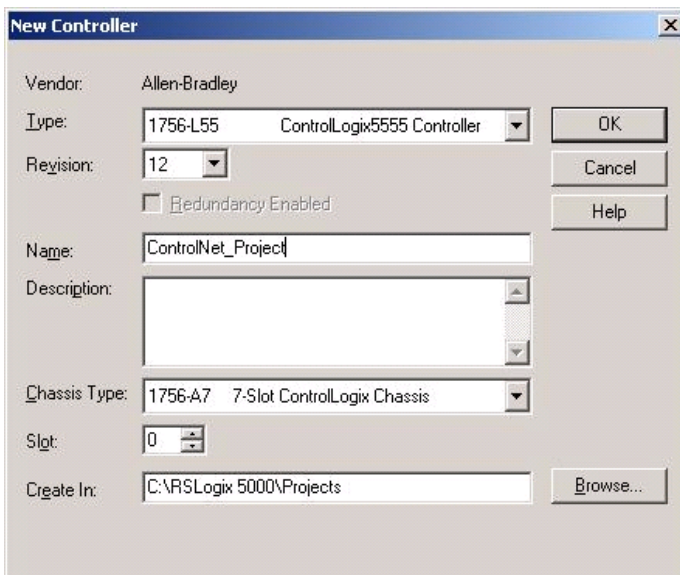

3. Right click on the I/O configuration and select New Module.

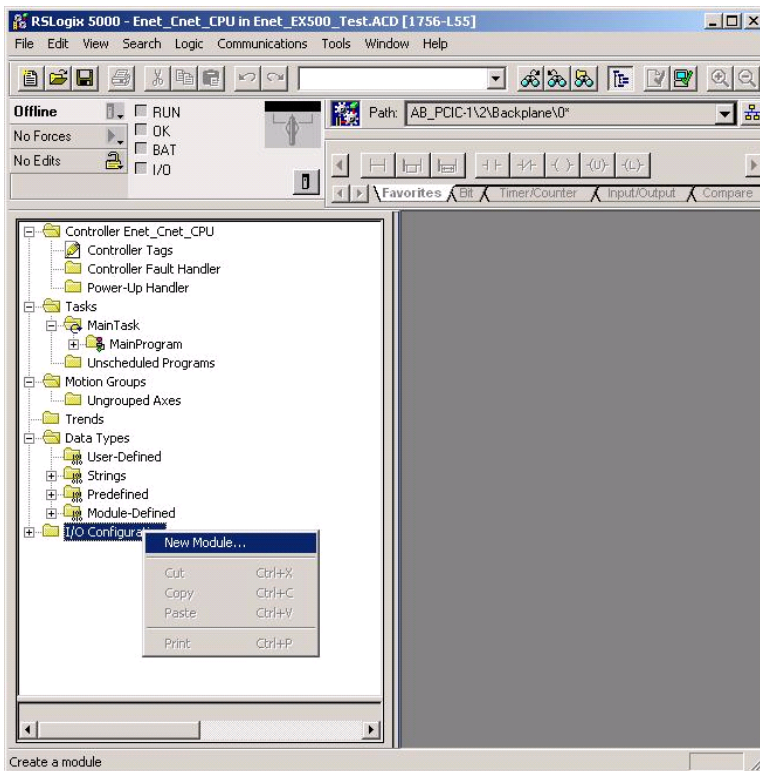

4. Select the EtherNet/IP scanner used in your PLC from the list and click OK.

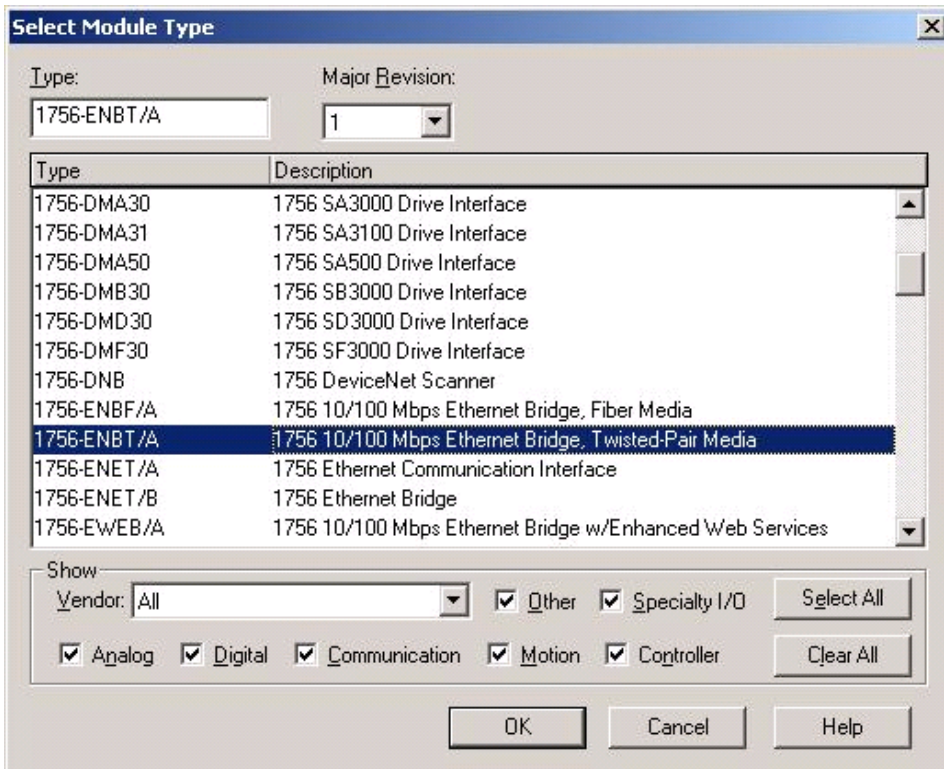

5. Name you scanner and enter the IP address and click on Finish. The module will appear under I/O configuration.

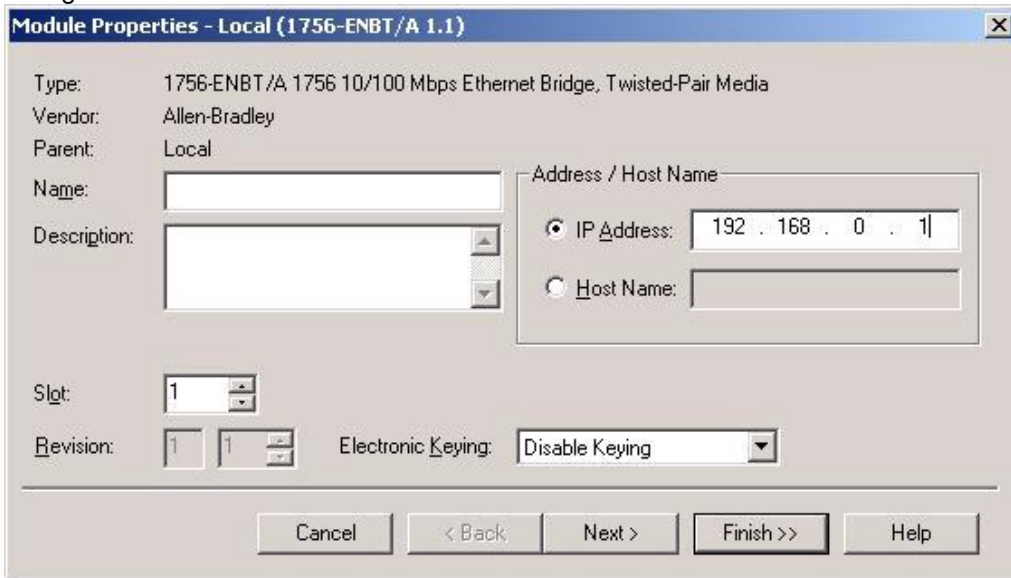

6. Right click on the EtherNet/IP scanner under I/O configuration and select New Module. We will add SMC EtherNet/IP module as Generic Ethernet Module.

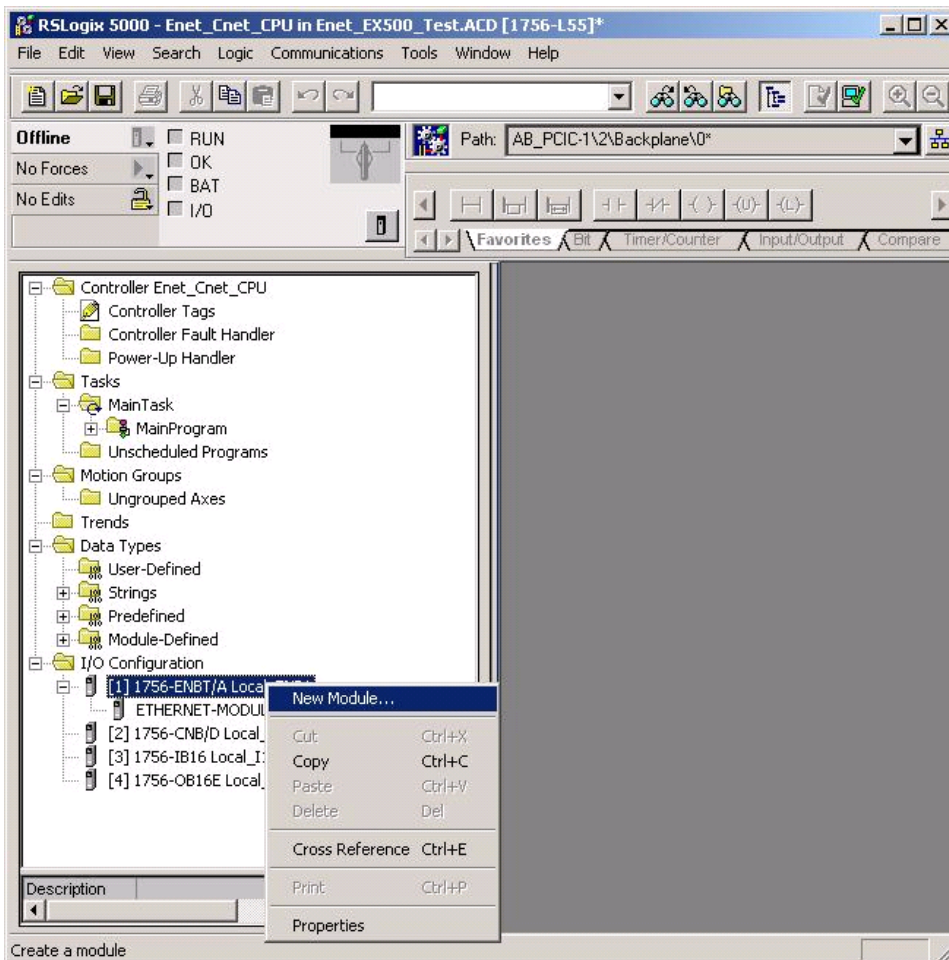

7. Select the Generic Ethernet Module and click OK

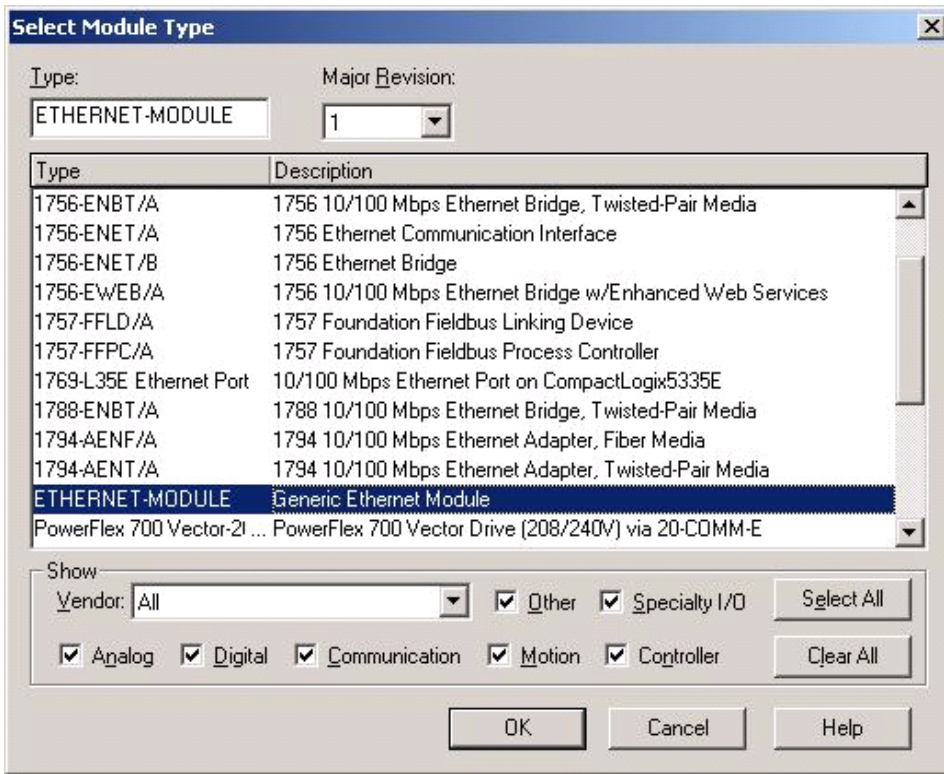

8. Name the module and enter the Comm Format, IP address and Connection Parameters.

Note: Set the Connection parameters and the Comm Format as shown in the screen shot.

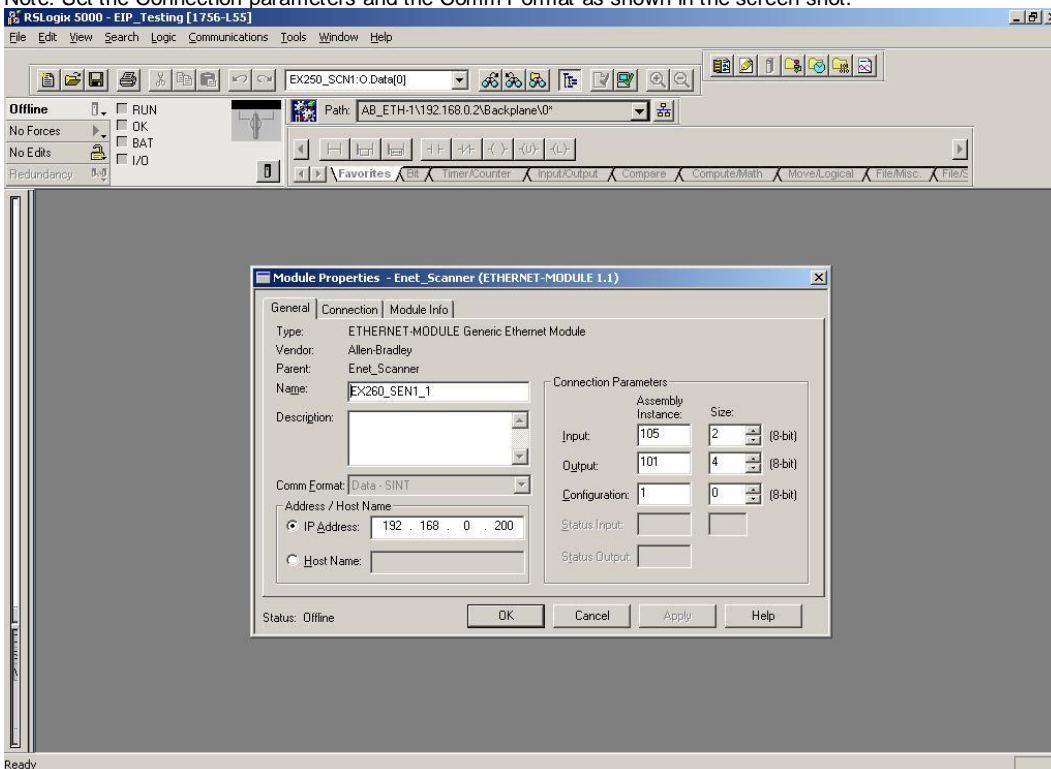

Refer to page 22 for IP address configuration

■ Output number assignment

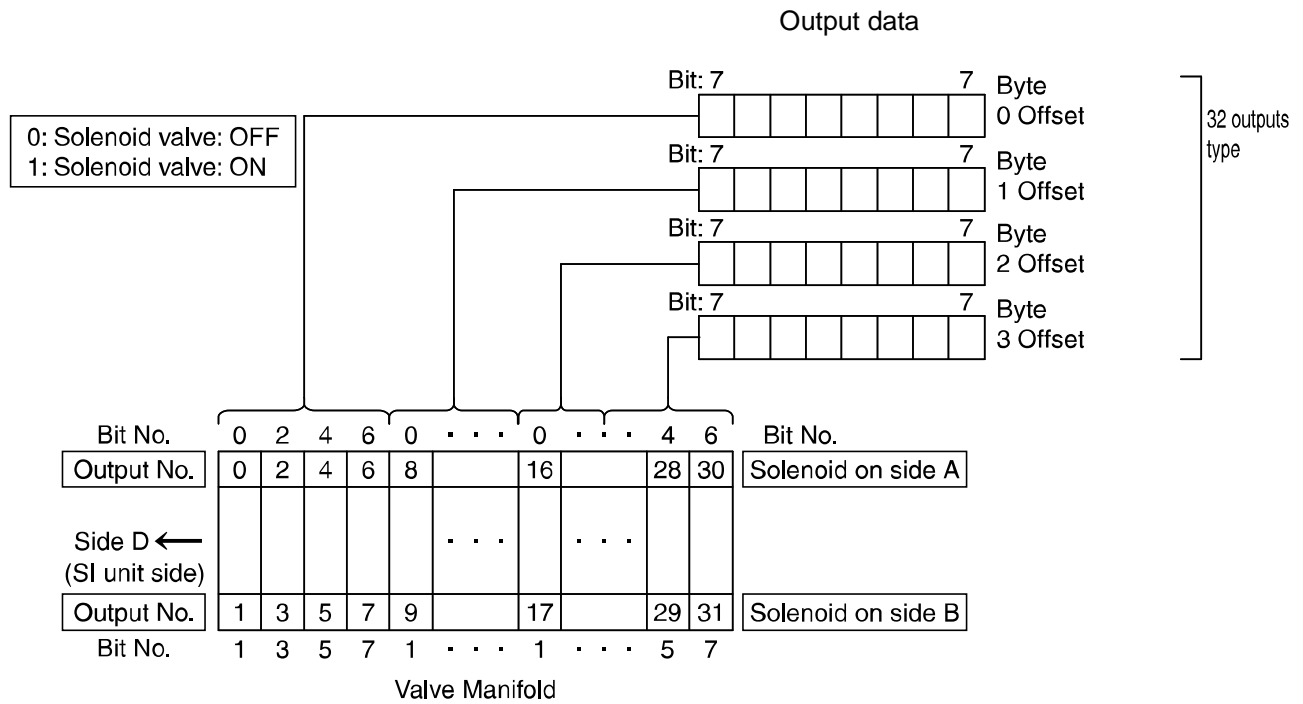

- *: The output number refers to the solenoid position on the manifold and starts at zero.
- *: Standard wiring on the manifold is for double-solenoid valves and output number starts A side and B side in that order as shown in the figure a.
If you mount a single-solenoid valve on the standard wiring manifold, output number for B side valve is skipped.
- *: Custom wiring for mixed mounting single-solenoid valves and double-solenoid-valves can be specified with a Wiring Specification Sheet. Example wiring is shown in the figure b.
- *: Bit status "0" and "1" on a data corresponds to solenoid valve status ON and OFF(0: OFF, 1: ON) and output number starts at zero from LSB (least significant bit).

fig.a

	No.	Station	No.
Double	4	3	5
Single	2	2	3 free
Double	0	1	1

fig.b

	No.	Station	No.
Double	3	3	4
Single	2	2	-
Double	0	1	1

Explicit I/O mapping

Class	Instances	Attributes	Size	Notes
0x65	0x65	0x03	4 Bytes	Valve Control

0x65 (101) Valve Control

Byte 1

Bit	Description	Explanation
0-7	Valve Control	Control of coils 1-8

Byte 2

Bit	Description	Explanation
0-7	Valve Control	Control of coils 9-16

Byte 3

Bit	Description	Explanation
0-7	Valve Control	Control of coils 17-24

Byte 4

Bit	Description	Explanation
0-7	Valve Control	Control of coils 25-32

Class	Instances	Attributes	Size	Notes
0x66	0x66	0x03	4 Bytes	Valve Diagnostic Control (Open Load Detection Enable)*1

0x66 (102) Valve Control

Byte 1

Bit	Description	Explanation
0-7	Diagnostic Control	Diagnostic Control of coils 1-8

Byte 2

Bit	Description	Explanation
0-7	Diagnostic Control	Diagnostic Control of coils 9-16

Byte 3

Bit	Description	Explanation
0-7	Diagnostic Control	Diagnostic Control of coils 17-24

Byte 4

Bit	Description	Explanation
0-7	Diagnostic Control	Diagnostic Control of coils 25-32

*1 Notes: Coil Diagnostics always on. Class 0x66 enables open coil detection. Do not enable open coil detection for any outputs that do not have a coil connected or a coil fault will be reported.

Class	Instances	Attributes	Size	Notes
0x67	0x67	0x03	4 Bytes	Valve Diagnostic

0x67 (103) Valve Control

Byte 1

Bit	Description	Explanation
0-7	Valve Diagnostic	Diagnostic Status of coils 1-8

Byte 2

Bit	Description	Explanation
0-7	Valve Diagnostic	Diagnostic Status of coils 9-16

Byte 3

Bit	Description	Explanation
0-7	Valve Diagnostic	Diagnostic Status of coils 17-24

Byte 4

Bit	Description	Explanation
0-7	Valve Diagnostic	Diagnostic Status of coils 25-32

Class	Instances	Attributes	Size	Notes
0x68	0x68	0x03	2 Bytes	Configuration

0x68 (104) Valve Control

Byte 1

Bit	Description	Explanation
0	Configuration	Generate Bus Fault
1	Configuration	Generate Valve Power Fault
2	Configuration	Generate Module Fault
3	Configuration	Manual Fault Clear
4	Configuration	Reboot
5	Configuration	Auto Fault Reset
6-7	For Future Use	-----

Byte 2

Bit	Description	Explanation
0-7	For Future Use	-----

Class	Instances	Attributes	Size	Notes
0x69	0x69	0x03	2 Bytes	Module diagnostic status

0x69 (105) Diagnostics Status

Byte 1

Bit	Description	Explanation
0	Valve power Fault	Valve Power not with specified range
1	System Fault	Ex. Out of range valve power and or coil malfunction
2	Bus Fault	Indicates a bus fault has occurred.
3-7	For Future use.	---

Byte 2

Bit	Description	Explanation
0-7	For Future use.	---

How to obtain the existing IP address of SMC Ethernet/IP module using Network Protocol Analyzer called WIRESHARK.

Step 1

Download and install on your PC the free copy of wireshark using the following link.

<http://www.wireshark.org/download.html>.

Step 2

Launch the wireshark network protocol analyzer. You will see a window as shown below.

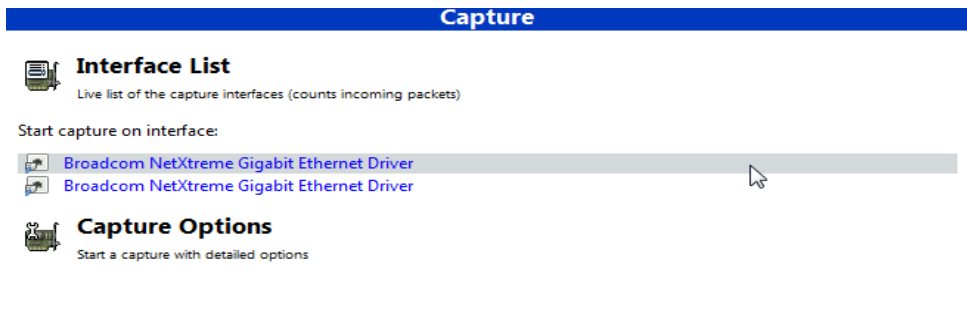

Step 3

If there are multiple Ethernet drivers in your PC, select the appropriate driver by double clicking on it. The following blank window will popup.

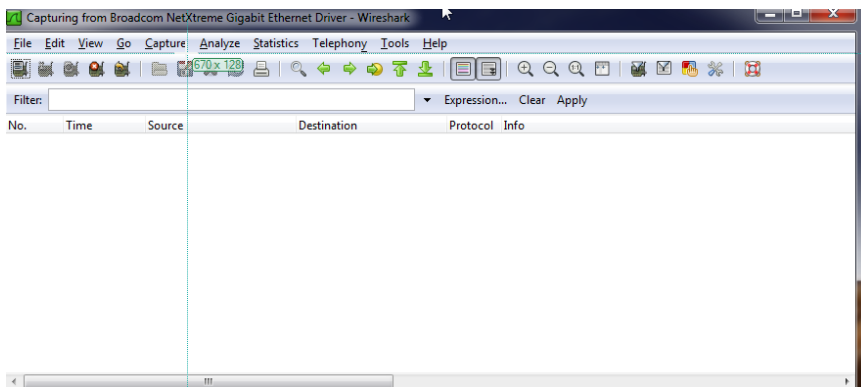

Step 4

Cycle the power to SMC Ethernet/IP module. Wireshark will start scanning the network and Ethernet module with the MAC-ID and current IP address will show up in the scanning window as show below.

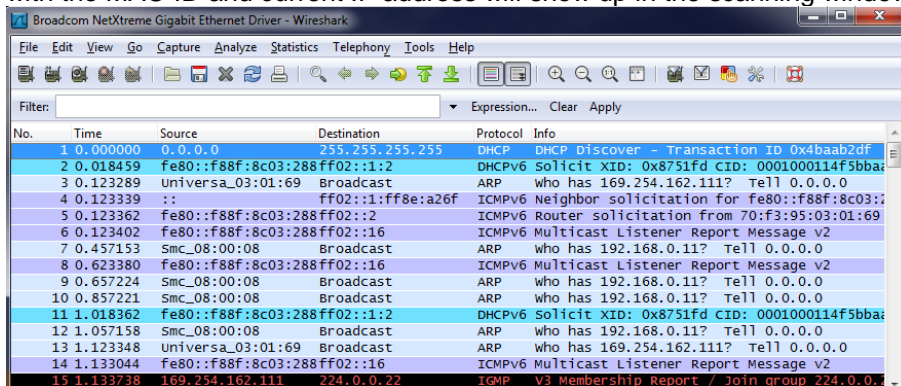

In this example the IP address of the SMC module is 192.168.0.11 as shown above at line 7.

Note 1: Using your Internet browser and the IP address of the module, user can access the webpage of the module.

Note 2: User can stop the scanning by selecting the "Capture" tab and "Stop" command or by pressing Ctrl+E.

Webpage

Using your Internet browser and the current IP address of the module, user can access the web server of the module.

The following parameters can be viewed and/or modified using webpage.

1. System
Show module information such as MAC and DHCP status
2. Diagnostics
Connection information and statistics
3. IO Data
Current Input and output data
4. Version
Application Versions
5. License
6. Login
Allows for configuration of the Module
 - i. Network
Can set IP address and DHCP setting here
 - ii. Email
 - iii. Time
7. Contact
8. Firmware Update

Type the IP address of the module into your internet browser as shown below.
The Default System page will open

System Page

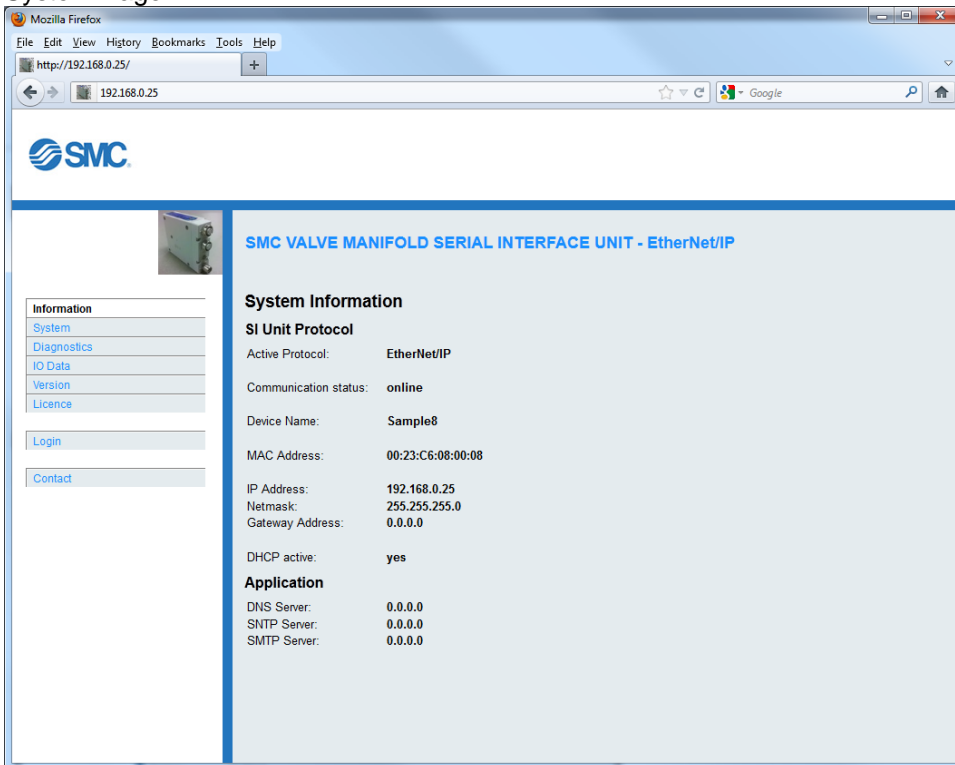

The screenshot shows a Mozilla Firefox browser window with the address bar set to `http://192.168.0.25/`. The page title is "SMC VALVE MANIFOLD SERIAL INTERFACE UNIT - EtherNet/IP". The main content area displays "System Information" for the "SI Unit Protocol".

SI Unit Protocol	
Active Protocol:	EtherNet/IP
Communication status:	online
Device Name:	Sample8
MAC Address:	00:23:C6:08:00:08
IP Address:	192.168.0.25
Netmask:	255.255.255.0
Gateway Address:	0.0.0.0
DHCP active:	yes
Application	
DNS Server:	0.0.0.0
SNTP Server:	0.0.0.0
SMTP Server:	0.0.0.0

Diagnostics Page

SMC VALVE MANIFOLD SERIAL INTERFACE UNIT - EtherNet/IP

Diagnostic Information

Ethernet Port 1
Inactive, Unknown Mbps, Unknown Duplex
Autonegotiation in progress

Ethernet Port 2
Active, 100 Mbps, Full Duplex
Successfully negotiated speed and duplex

CIP Connection Statistics

Active Explicit Msg Connections: 0
Explicit Msg Connections Supported: 20
Total Explicit Msg Connections Observed: 0
Active I/O Connections: 0
I/O Connections Supported: 10
Total I/O Connections Observed: 0
Conn Open Requests: 0
Open Request Errors: 0
Conn Close Requests: 0
Close Request Errors: 0
Conn Timeouts: 0

TCP Connection Statistics

Active TCP Connections: 0
TCP Connections Supported: 10
Total TCP Connections Observed: 0

CIP Explicit Messaging Statistics

Connected Messages Sent: 0
Connected Messages Received: 0
Unconnected Messages Sent: 0
Unconnected Messages Received: 0

CIP I/O Messaging Statistics

	Speed	Total
Sent:	0	0
Received:	0	0
Inhibited:	0	0
Rejected:	0	0
Missed:	0	0
Total:	0	0

I/O Packet Capacity: 500
Theoretical reserve I/O Capacity: 500
Actual reserve I/O Capacity: 500

IO Data

SMC VALVE MANIFOLD SERIAL INTERFACE UNIT - EtherNet/IP

IO Data

#	Unit ID	Type	Data status	Data size	Data
0	0x00000065	Output	bad	4	0x00000000
1	0x00010066	Output	bad	4	0x00000000
2	0x00020067	Input	good	4	0x00000000
3	0x00030068	Output	bad	2	0x0000
4	0x00040069	Input	good	2	0x0000

Click on the “IO Data” to review the IO Data size of the module as shown. Data status let you know if the data has been written to since power up.

Version

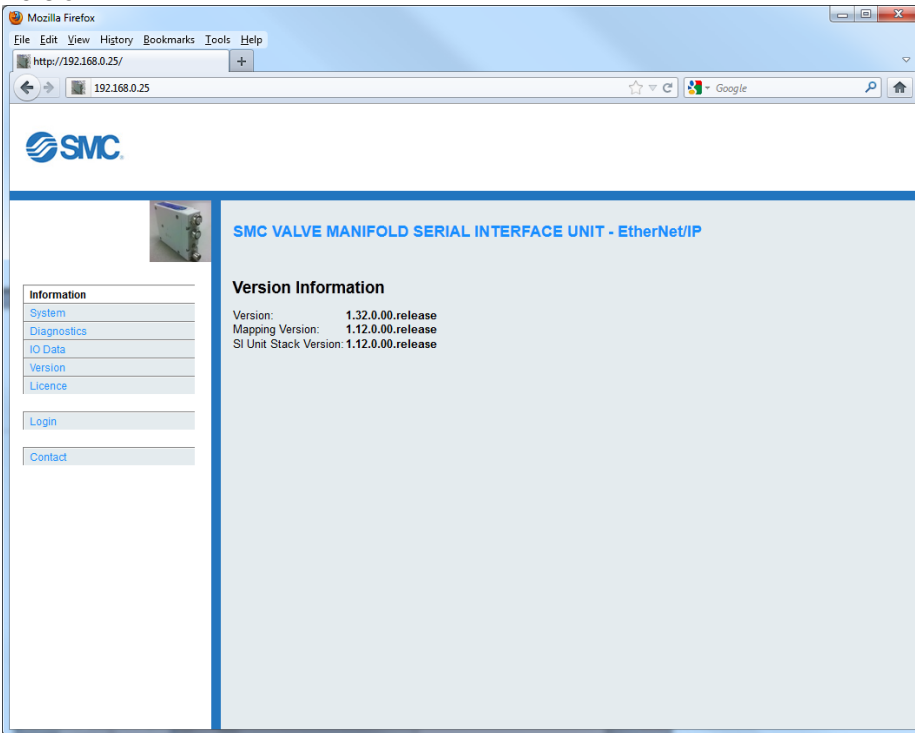

Click on the "Version" to review the application versions of the module.

License

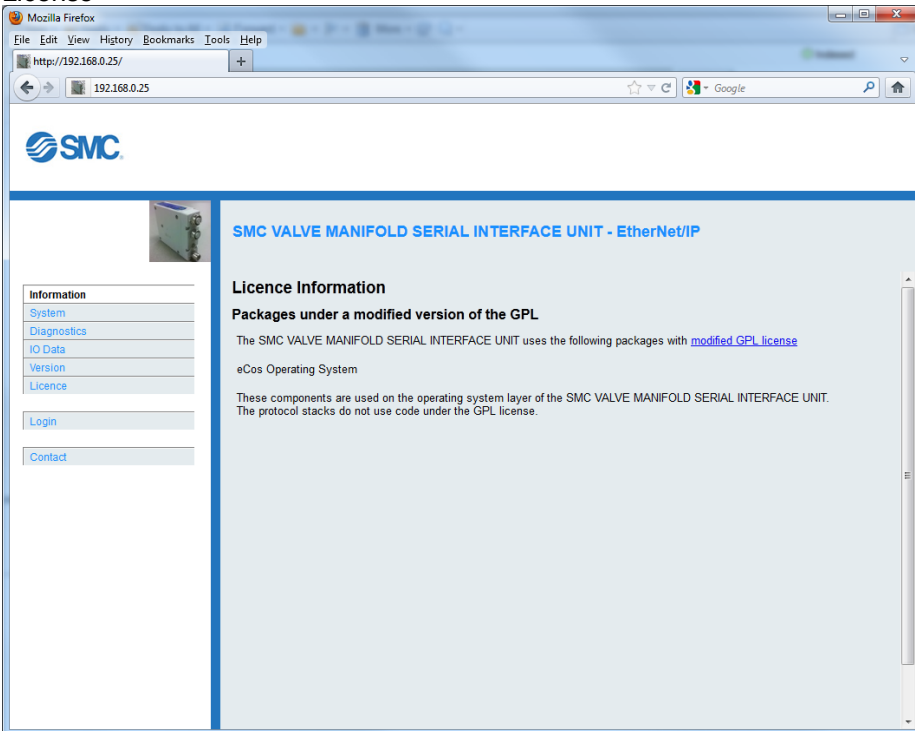

Click on the "License" to review the license information of the module.

Login

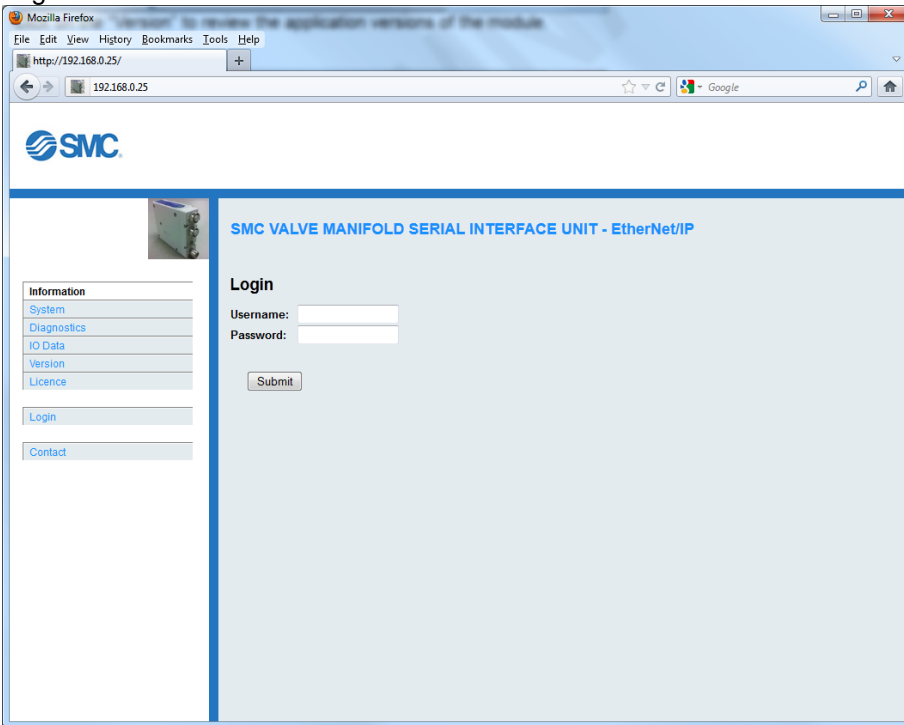

Click on Login and enter "user" for both Username and Password.

Logged in successfully

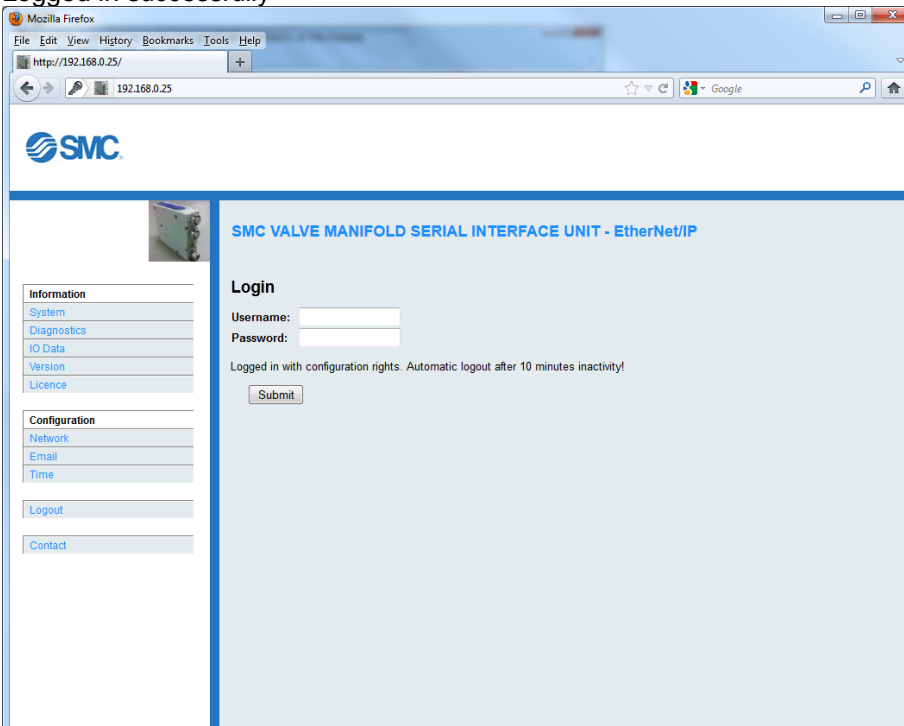

Network

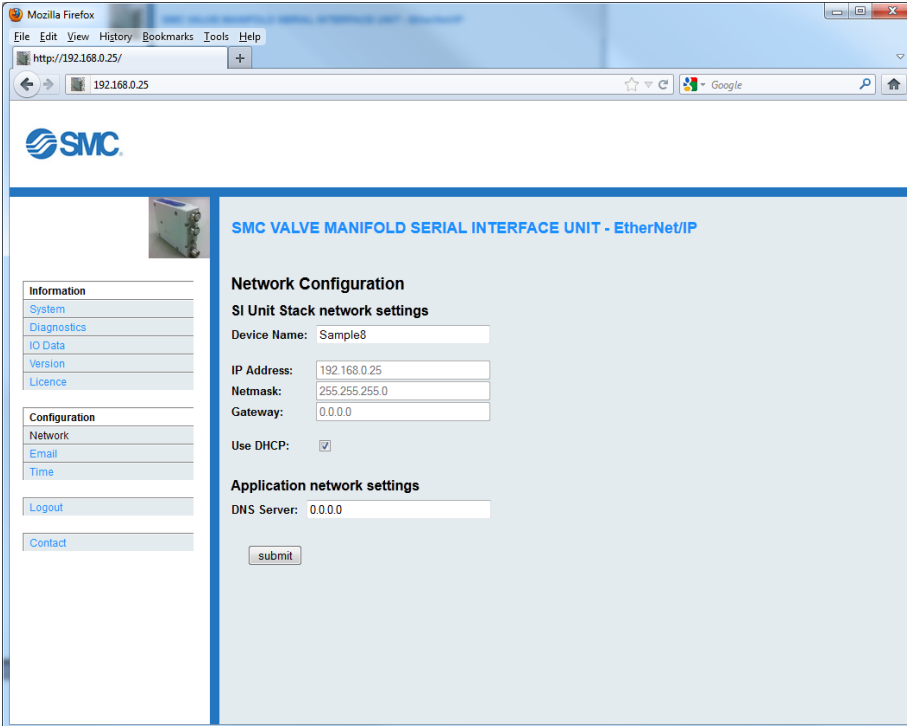

Click on Network to configure IP Address and DHCP. Device name, Netmask, Gateway, and DNS server can also be configured from this page.

Email

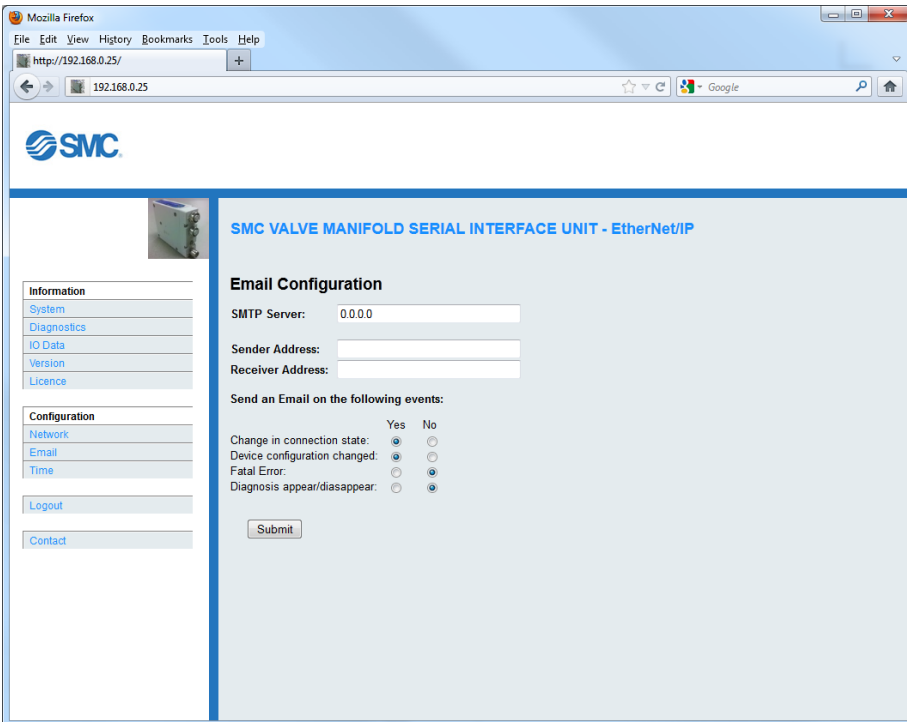

Click on Email to configure email settings

Time

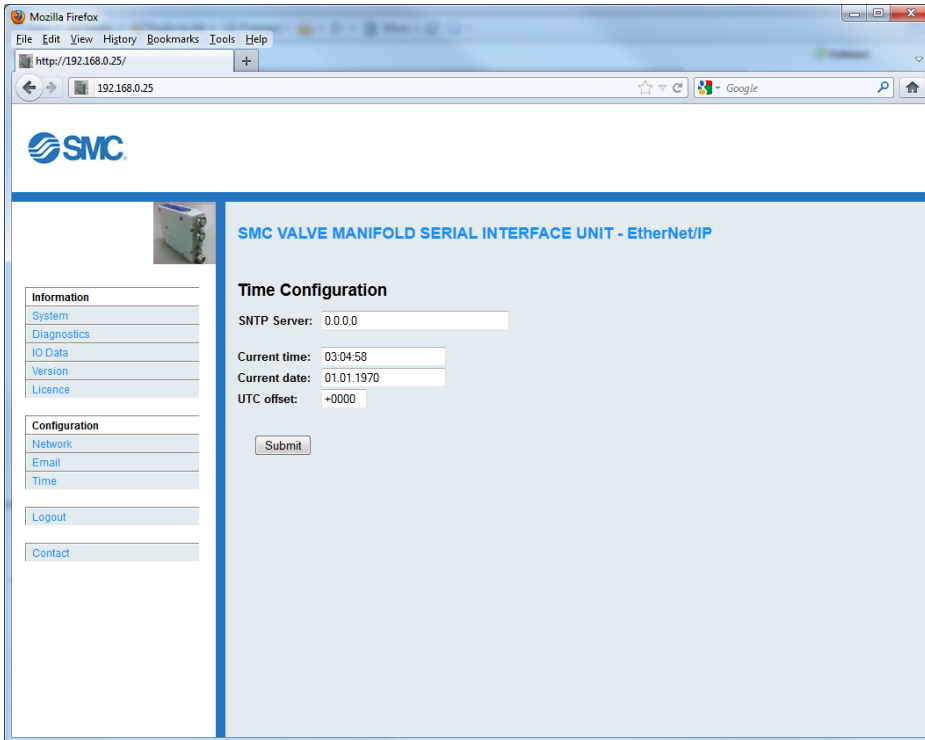

Click on Time to set time

Logout

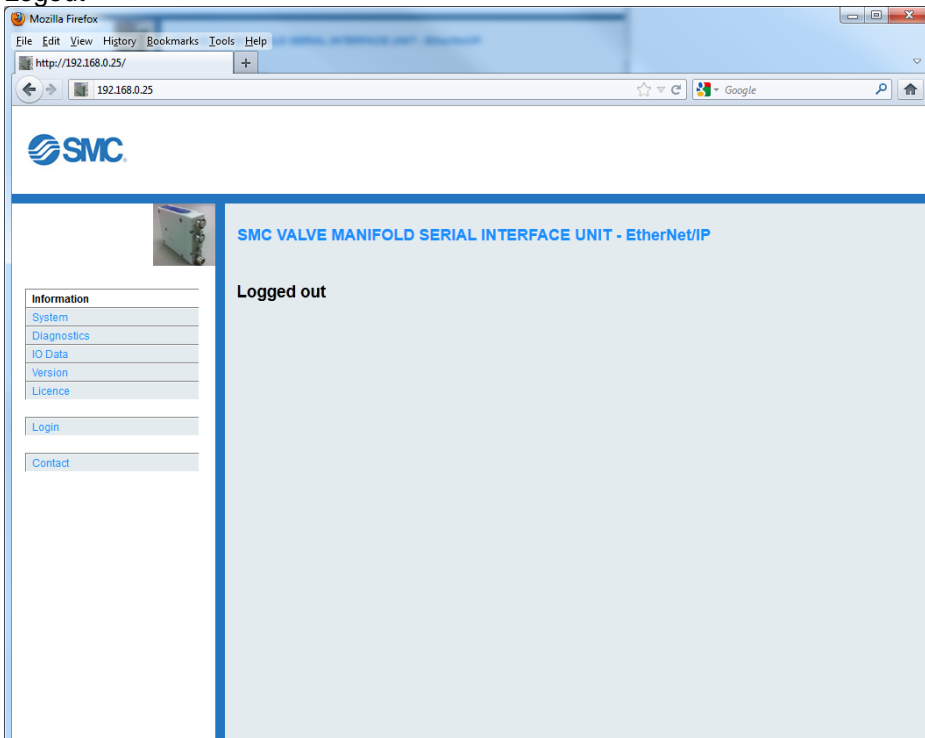

Contact

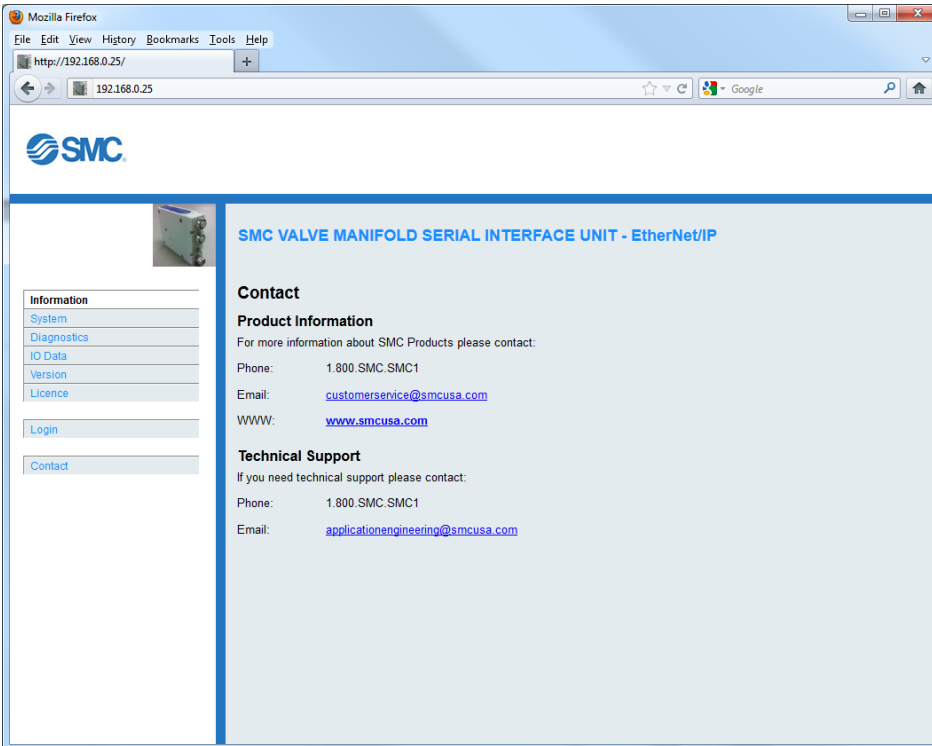

The screenshot shows a Mozilla Firefox browser window displaying the SMC web interface. The address bar shows the URL <http://192.168.0.25/>. The page title is "SMC VALVE MANIFOLD SERIAL INTERFACE UNIT - EtherNet/IP". The left sidebar contains a navigation menu with the following items: Information, System, Diagnostics, IO Data, Version, Licence, Login, and Contact. The main content area is titled "Contact" and contains the following information:

Product Information
For more information about SMC Products please contact:
Phone: 1.800.SMC.SMC1
Email: customerservice@smcusa.com
WWW: www.smcusa.com

Technical Support
If you need technical support please contact:
Phone: 1.800.SMC.SMC1
Email: applicationengineering@smcusa.com

Click on the "Contact" to review the contact information for Technical Support.

Firmware Update

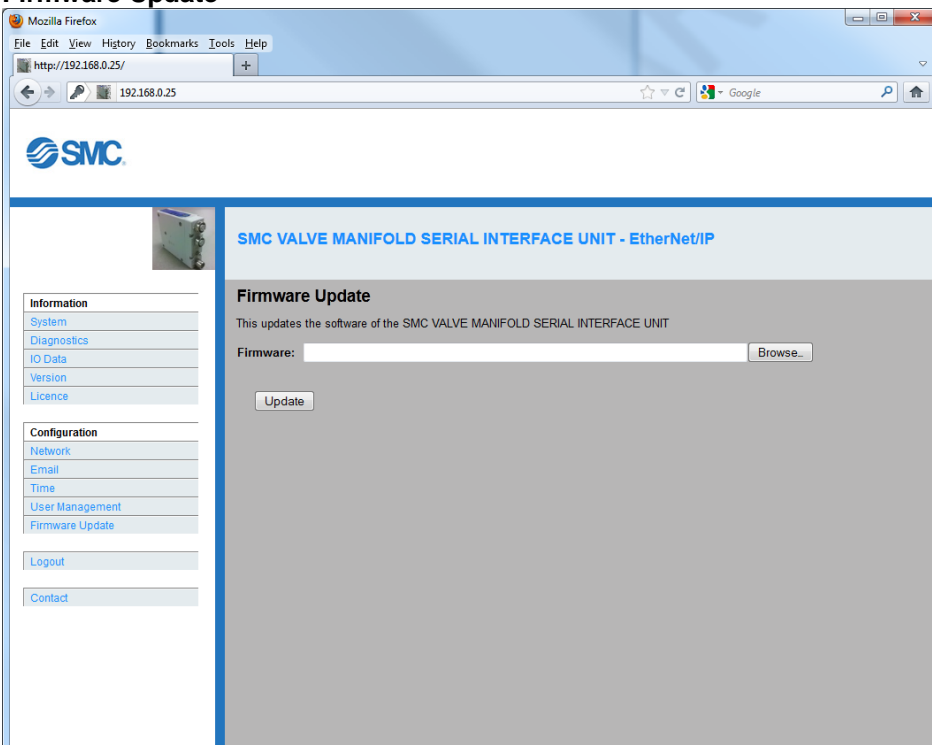

The screenshot shows a Mozilla Firefox browser window displaying the SMC web interface. The address bar shows the URL <http://192.168.0.25/>. The page title is "SMC VALVE MANIFOLD SERIAL INTERFACE UNIT - EtherNet/IP". The left sidebar contains a navigation menu with the following items: Information, System, Diagnostics, IO Data, Version, Licence, Configuration, Login, and Contact. The main content area is titled "Firmware Update" and contains the following information:

This updates the software of the SMC VALVE MANIFOLD SERIAL INTERFACE UNIT

Firmware:

If a firmware update is required contact SMC for assistance. To download the new firmware, select the "Firmware Update" under "Configuration" tab. Browse and select the new firmware and click on Update.

Troubleshooting and Maintenance

■ Troubleshooting chart

When any malfunction is observed, it is recommended to perform the following troubleshooting.

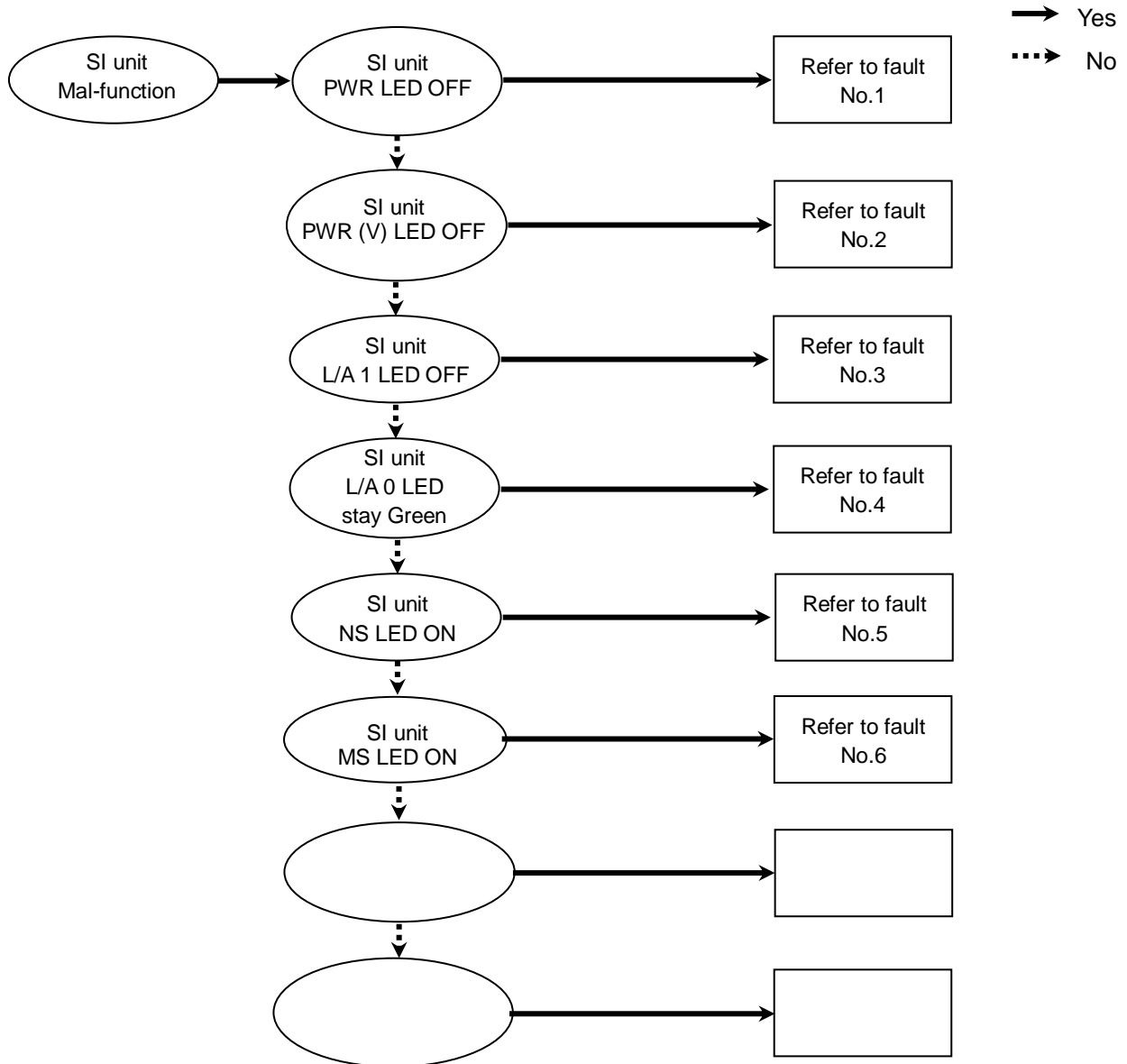

■ Troubleshooting table

Fault No.1

Fault	Probable cause	Recommended error handling	Recommended action
SI unit PWR_LED OFF	Defective power cable wiring for SI unit operation	Check the condition of the power cable wiring to the SI unit.	Re-tighten the power cable. (Replace the cable if it is broken)
			Correct the power cable wiring layout.
	SI unit operating voltage is not supplied	Check the condition of the supply voltage to the SI unit.	Supply 24 VDC +/-10% to the SI unit.

Fault No.2

Fault	Probable cause	Recommended error handling	Recommended action
SI unit PWR(V)_LED OFF	Defective power cable wiring for the solenoid valve	Check the condition of the power cable wiring for the valve.	Re-tighten the power cable. (Replace the cable if it is broken)
			Correct the power cable wiring layout.
	Load voltage for the valve is not supplied	Check the condition of the supply voltage for the valve.	Supply 24 VDC +10%/-5% to the valve.

Fault No.3

Fault	Probable cause	Recommended error handling	Recommended action
SI unit L/A 1 LED OFF	The connection to the upper side device has failed	Check the condition of the upstream device.	Supply voltage to the upstream device.
		Check the condition of L/A IN side bus cable wiring, and that there is no broken bus cable.	Re-tighten the bus cable. (Replace the cable if it is broken)
		Check that there is no noise source or high voltage line around the bus cables.	Keep noise sources away from the bus cable.
		Check the connection of the ground terminal.	Connect the ground terminal to ground.

Fault No.4

Fault	Probable cause	Recommended error handling	Recommended action
SI unit L/A 0 LED OFF	No communication with Ethernet master	Check the condition of the Ethernet master.	Set the Ethernet master to RUN state.
		Check the condition of the upstream device. (Check that there are no L/A LED's indicating OFF on any upstream devices)	Supply voltage to the upstream device. Re-tighten the bus cable. (Replace the cable if it is broken)
		Check that there is no noise source or high voltage line around the bus cables.	Keep noise sources away from the bus cable.

Fault No.5

Fault	Probable cause	Recommended error handling	Recommended action
SI unit NS LED ON			

Fault No.6

Fault	Probable cause	Recommended error handling	Recommended action
SI unit MS LED ON			

Fault No.7

Fault	Probable cause	Recommended error handling	Recommended action
All valves and valve LEDs are not operating	Poor connection between SI unit and valve manifold	Check if there are any loose screws making the connection between the SI unit and the valve manifold	Tighten the screws with the specified tightening torque (i.e. 0.6 Nm) and make sure there is no gap between the SI unit and the valve manifold.
	Mismatch polarity between solenoid valve and SI unit output	Check if the solenoid valve common specification matches the output polarity of the SI unit.	Match polarity between solenoid valve and SI unit output.
	Defective solenoid valve	Follow the troubleshooting for the solenoid valve.	Same as left.

Fault No.8

Fault	Probable cause	Recommended error handling	Recommended action
Valves do not work but valve LEDs are operating	Mismatch polarity between solenoid valve and SI unit output	Check if the solenoid valve common specification matches the output polarity of the SI unit.	Match polarity between solenoid valve and SI unit output.

■Maintenance

Replacement of the SI unit

- Remove the M3 hexagon screws from the SI unit and release the SI unit from the valve manifold.
- Replace the SI unit.
- Tighten the screws with the specified tightening torque. (0.6 Nm)

Precautions for maintenance

- (1) Be sure to switch off the power.
- (2) Check there is no foreign matter inside the SI unit.
- (3) Check there is no damage and no foreign matter on the gasket.
- (4) Be sure to tighten the screws with the specified torque

If the SI unit is not assembled properly, inside PCBs may be damaged or liquid and/or dust may enter into the unit.

Assembly and disassembly of the SI unit

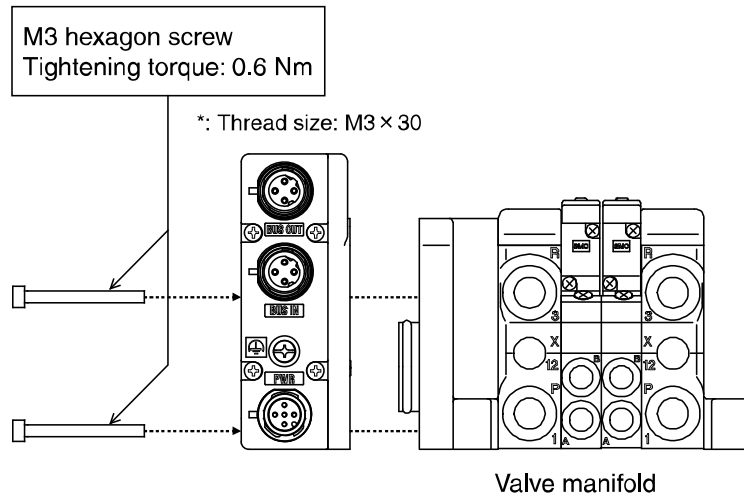

Specifications

■ Table of Specifications

General specifications

Item	Specifications
Ambient temperature	-10 to +50 °C
Ambient humidity	35 to 85%RH (No condensate)
Ambient temperature for storage	-20 to +60 °C
Vibration resistance	10 to 57 Hz 0.3mm (Constant amplitude) 57 to 150 Hz 50 m/s ² (Constant acceleration)
Impact resistance	Peak value 150 m/s ² applied for 11ms three times each in X, Y and Z directions.
Withstand voltage	500 VAC applied for 1 minute
Insulation resistance	500 VDC, 10 MΩ or more
Operating atmosphere	No corrosive gas
Pollution degree	Pollution degree 2
Weight	200 g or less

Electrical specifications

Item		Specifications	
Current consumption in power supply voltage range	Current consumption of controller power supply	21.6~26.4 VDC 0.1 A max.	
	Solenoid valve power supply	22.8~26.4 VDC 2.0 A or less, according to the solenoid valve station specification	
Solenoid valve connecting specification	Output type	UIUSP-SEN1-DUO02979	PNP (negative common)
		UIUSP-SEN2-DUO02979	NPN (positive common)
	Output condition at the time of communication error	Output clear	
	Connected load	Solenoid valve with light and surge voltage suppressor of 24 VDC and 1.5 W or less (manufactured by SMC)	
	Insulation type	RF-based digital isolator	
	Residual voltage	0.4 VDC or less	

Network communication specifications

Item		Specifications
Protocol		EtherNet/IP (IEEE802.3)
Media		100BASE-TX
Transmission speed		100 Mbps
Transmission medium		Standard Ethernet cable (CAT5) (100BASE-TX)
Number of nodes connected		(Up to 65,535 nodes.)
Network topology		Daisy chain
Maximum segment length		Up to 100 m (328 ft)
Address setting		Manual setting is not required, automatically set
Number of outputs	UIUSP-SEN1-DUO02979	32 outputs
	UIUSP-SEN2-DUO02979	
Vendor ID		00000007 hex (7)
Product code	UIUSP-SEN1-DUO02979	PNP Output (Negative Common)
	UIUSP-SEN2-DUO02979	NPN Output (Positive Common)

Connectable valve series

Valve Series	
SY series	SY3000, SY5000
VQC series	VQC1000, VQC2000, VQC4000
SV series	SV1000, SV2000, SV3000 (Type 10, tie-rod base)
S0700 series	S0700

* The valve manifolds that can be connected are the same as those connectable to EX250 series.

Dimensions

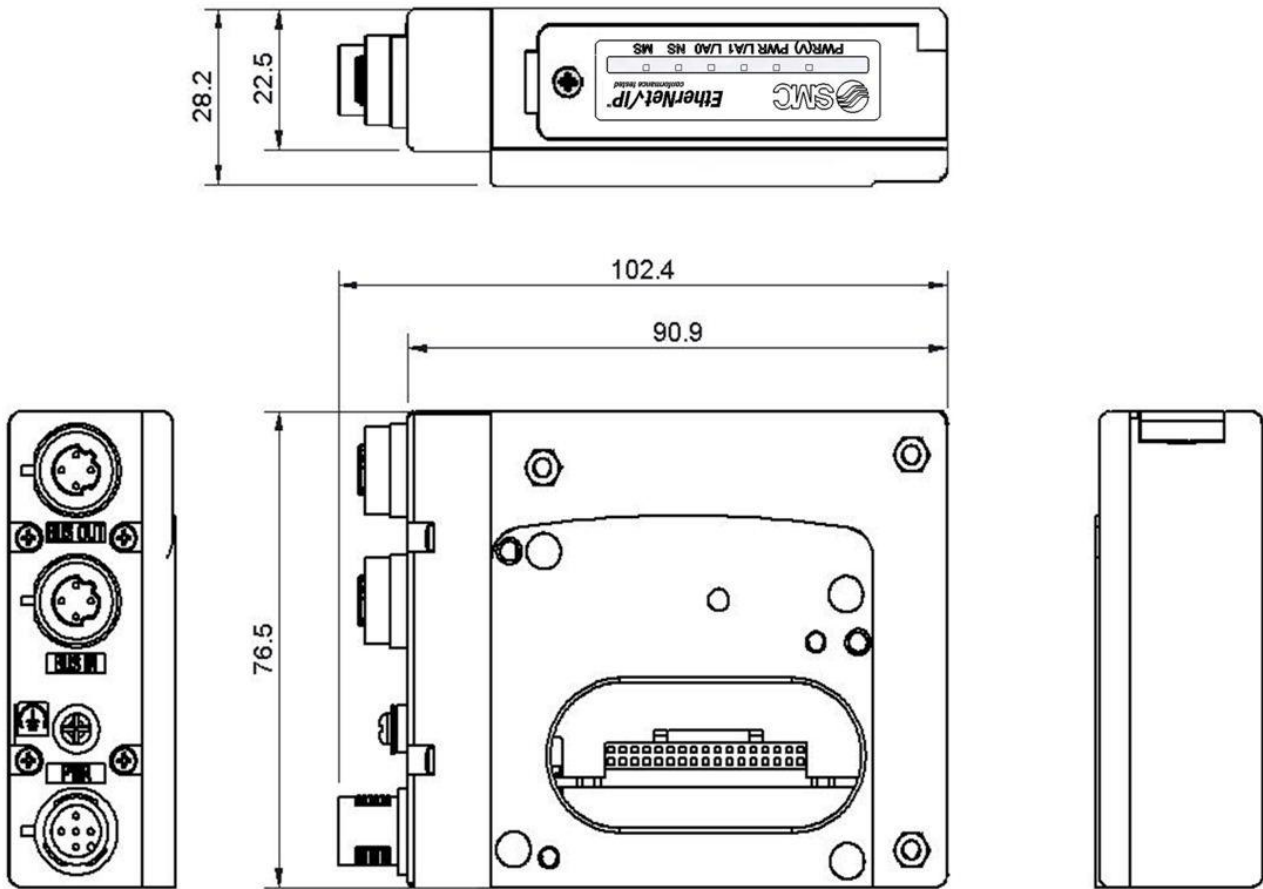

Accessories

Connector cable

	SI unit connector	Compatible connector		
		Description	Part number	Specifications
1	Fieldbus interface connector (BUS OUT)	Cable with communication connector	EX9-AC020EN-PSRJ: 2m EX9-AC050EN-PSRJ: 5m	Connector: M12 straight at one end and RJ45 at the other end.
			PCA-1446566	Connector: M12 Straight on one end and flying leads at the other end. Cable 5m
		Fieldwireable Connector	PCA-1446553	Connector: M12 straight plug
2	Power supply connector	Cable with power supply connector	EX500-AP010-S	Connector: M12 straight Cable: 1m
			EX500-AP050-S	Connector: M12 straight Cable: 5m
			EX500-AP010-A	Connector: M12 angle Cable: 1m
			EX500-AP050-A	Connector: M12 angle Cable: 5m
		Cable with power supply connector (with Speedcon)	PCA-1401804	Connector: M12 Straight Cable: 1.5m
			PCA-1401805	Connector: M12 Straight Cable: 3m
			PCA-1401806	Connector: M12 Straight Cable: 5m

Seal cap (10 pcs.)

The seal cap can be used to protect the opening M12 size connector socket, i.e. M12 "BUS OUT" connector on the SI unit.

When M12 "BUS OUT" connector is not used, the seal cap can keep the SI unit under IP67 rated protection.

(One seal cap will be attached to the SI unit when shipped from factory.)



Description	Part No.	Specification
Seal cap	EX9-AWTS	For M12 connector socket: 10pcs.

Revision history
Revision A: Revise some wording

SMC Corporation

Akihabara UDX 15F,
4-14-1, Sotokanda, Chiyoda-ku, Tokyo 101-0021, JAPAN
Phone: +81 3-5207-8249 Fax: +81 3-5298-5362
URL <http://www.smcworld.com>

