



Operation Manual

Coolant valve

PRODUCT NAME

VNC/VNH Series

MODEL / Series / Product Number

SMC Corporation

Contents

Safety Instructions	2,3
Precautions on Design	4
Selection	4
Mounting	4
Piping	5
Operating Environment	5
Maintenance	5
Precautions	5
How to use DIN connector	6
Indicator Light/Surge Voltage Suppressor	6
Electrical Connections	6
Specific Product Precautions	7,8
Troubleshooting	9



Safety Instructions

These safety instructions are intended to prevent hazardous situations and/or equipment damage. These instructions indicate the level of potential hazard with the labels of "Caution," "Warning" or "Danger." They are all important notes for safety and must be followed in addition to International Standards (ISO/IEC)^{*1)}, and other safety regulations.

*1) ISO 4414: Pneumatic fluid power -- General rules relating to systems.

ISO 4413: Hydraulic fluid power -- General rules relating to systems.

IEC 60204-1: Safety of machinery -- Electrical equipment of machines .(Part 1: General requirements)

ISO 10218-1992: Manipulating industrial robots -Safety.

etc.



Caution

Caution indicates a hazard with a low level of risk which, if not avoided, could result in minor or moderate injury.



Warning

Warning indicates a hazard with a medium level of risk which, if not avoided, could result in death or serious injury.



Danger

Danger indicates a hazard with a high level of risk which, if not avoided, will result in death or serious injury.

Warning

1. The compatibility of the product is the responsibility of the person who designs the equipment or decides its specifications.

Since the product specified here is used under various operating conditions, its compatibility with specific equipment must be decided by the person who designs the equipment or decides its specifications based on necessary analysis and test results.

The expected performance and safety assurance of the equipment will be the responsibility of the person who has determined its compatibility with the product.

This person should also continuously review all specifications of the product referring to its latest catalog information, with a view to giving due consideration to any possibility of equipment failure when configuring the equipment.

2. Only personnel with appropriate training should operate machinery and equipment.

The product specified here may become unsafe if handled incorrectly.

The assembly, operation and maintenance of machines or equipment including our products must be performed by an operator who is appropriately trained and experienced.

3. Do not service or attempt to remove product and machinery/equipment until safety is confirmed.

1. The inspection and maintenance of machinery/equipment should only be performed after measures to prevent falling or runaway of the driven objects have been confirmed.

2. When the product is to be removed, confirm that the safety measures as mentioned above are implemented and the power from any appropriate source is cut, and read and understand the specific product precautions of all relevant products carefully.

3. Before machinery/equipment is restarted, take measures to prevent unexpected operation and malfunction.

4. Contact SMC beforehand and take special consideration of safety measures if the product is to be used in any of the following conditions.

1. Conditions and environments outside of the given specifications, or use outdoors or in a place exposed to direct sunlight.

2. Installation on equipment in conjunction with atomic energy, railways, air navigation, space, shipping, vehicles, military, medical treatment, combustion and recreation, or equipment in contact with food and beverages, emergency stop circuits, clutch and brake circuits in press applications, safety equipment or other applications unsuitable for the standard specifications described in the product catalog.

3. An application which could have negative effects on people, property, or animals requiring special safety analysis.

4. Use in an interlock circuit, which requires the provision of double interlock for possible failure by using a mechanical protective function, and periodical checks to confirm proper operation.



Safety Instructions

Caution

1. The product is provided for use in manufacturing industries.

The product herein described is basically provided for peaceful use in manufacturing industries. If considering using the product in other industries, consult SMC beforehand and exchange specifications or a contract if necessary.
If anything is unclear, contact your nearest sales branch.

Limited warranty and Disclaimer/Compliance Requirements

The product used is subject to the following “Limited warranty and Disclaimer” and “Compliance Requirements”.

Read and accept them before using the product.

Limited warranty and Disclaimer

1. The warranty period of the product is 1 year in service or 1.5 years after the product is delivered, whichever is first.*2)

Also, the product may have specified durability, running distance or replacement parts. Please consult your nearest sales branch.

2. For any failure or damage reported within the warranty period which is clearly our responsibility, a replacement product or necessary parts will be provided.

This limited warranty applies only to our product independently, and not to any other damage incurred due to the failure of the product.

3. Prior to using SMC products, please read and understand the warranty terms and disclaimers noted in the specified catalog for the particular products.

***2) Vacuum pads are excluded from this 1 year warranty.**

A vacuum pad is a consumable part, so it is warranted for a year after it is delivered. Also, even within the warranty period, the wear of a product due to the use of the vacuum pad or failure due to the deterioration of rubber material are not covered by the limited warranty.

Compliance Requirements

1. The use of SMC products with production equipment for the manufacture of weapons of mass destruction (WMD) or any other weapon is strictly prohibited.

2. The exports of SMC products or technology from one country to another are governed by the relevant security laws and regulations of the countries involved in the transaction. Prior to the shipment of a SMC product to another country, assure that all local rules governing that export are known and followed.



VNC / VNH Series Solenoid Valves for Fluid Control Precautions 1

Be sure to read this before handling.

Design

Warning

1. Cannot be used as an emergency shutoff valve, etc.

The valves presented in this catalog are not designed for safety applications such as an emergency shutoff valve. If the valves are used in this type of system, other reliable safety assurance measures should also be adopted.

2. This solenoid valve cannot be used for explosion proof applications.

3. Ensure sufficient space for maintenance activities.

When installing the products, allow access for maintenance.

4. Liquid rings

In cases with a flowing liquid, provide a by-pass valve in the system to prevent the liquid from entering the liquid seal circuit.

5. Pressure (including vacuum) holding

It is not usable for an application such as holding the pressure (including vacuum) inside of a pressure vessel because air leakage is entailed in a valve.

6. When the conduit type is used as equivalent to an IP54 enclosure, install a wiring conduit, etc.

7. When an impact, such as water hammer, etc., caused by the rapid pressure fluctuation is applied, the solenoid valve may be damaged. Give an attention to it.

Selection

Warning

1. Confirm the specifications.

Give careful consideration to the operating conditions such as the application, fluid and environment, and use within the specified operating ranges in this catalog.

2. Type of fluids

Before using a fluid, confirm whether it is compatible with the materials from each model by referring to the fluids listed in the catalog. Use a fluid with a dynamic viscosity of 50mm²/s or less. If there is something you do not know, please contact SMC.

3. Fluid quality

The use of a fluid that contains foreign matter can cause problems such as malfunction and seal failure by promoting wear of the valve seat and armature, and by sticking to the sliding parts of the armature, etc. Install a suitable filter (strainer) immediately upstream from the valve. As a general rule, use 80 to 100 mesh.

4. Air quality

1) Use clean air.

Do not use compressed air that contains chemicals, synthetic oils including organic solvents, salt or corrosive gases, etc., as it can cause damage or malfunction.

2) Install air filters.

Install air filters close to valves at their upstream side. A filtration degree of 5 μm or less should be selected.

Selection

Warning

3) Install an aftercooler or air dryer, etc.

Compressed air that contains excessive drainage may cause malfunction of valves and other pneumatic equipment. To prevent this, install an aftercooler or air dryer, etc.

4) If excessive carbon powder is generated, eliminate it by installing mist separators at the upstream side of valves.

If excessive carbon powder is generated by the compressor, it may adhere to the inside of the valves and cause malfunction.

Refer to SMC's Best Pneumatics catalog for further details on compressed air quality.

5. Ambient environment

Use within the operable ambient temperature range. Confirm the compatibility between the product's composition materials and the ambient atmosphere. Be certain that the fluid used does not touch the external surface of the product.

6. Countermeasures against static electricity

Take measures to prevent static electricity since some fluids can cause static electricity.

7. Low temperature operation

When using valves for water application in cold climates, take appropriate countermeasures to prevent the water from freezing in tubing after cutting the water supply from the pump, by draining the water, etc. When warming by a heater, etc., be careful not to expose the coil portion to a heater. Installation of a dryer, heat retaining of the body is recommended to prevent a freezing condition in which the dew point temperature is high and the ambient temperature is low, and the high flow runs.

Mounting

Warning

1. If air leakage increases or equipment does not operated properly, stop operation.

After mounting is completed, confirm that it has been done correctly by performing a suitable function test.

2. Do not apply external force to the coil section.

When tightening is performed, apply a wrench or other tool to the outside of the piping connection parts.

3. Mount a valve with its coil position upwards, not downwards.

4. Do not warm the coil assembly with a heat insulator, etc.

Use tape, heaters, etc., for freeze prevention on the piping and body only. They can cause the coil to burn out.

5. Secure with brackets, except in the case of steel piping and copper fittings.

6. Avoid sources of vibration, or adjust the arm from the body to the minimum length so that resonance will not occur.

7. Painting and coating

Warnings or specifications printed or labeled on the product should not be erased, removed or covered up.



VNC / VNH Series Solenoid Valves for Fluid Control Precautions 2

Be sure to read this before handling.

Piping

⚠ Caution

1. Preparation before piping

Before piping is connected, it should be thoroughly blow out with air (flushing) or washed to remove chips, cutting oil and other debris from inside the pipe.

Install piping so that it does not apply pulling, pressing, bending or other forces on the valve body.

2. Wrapping of pipe tape

When connecting pipes, fittings, etc., be sure that chips from the pipe threads and sealing material do not enter the valve.

Furthermore, when pipe tape is used, leave 1.5 to 2 thread ridges exposed at the end of the threads.

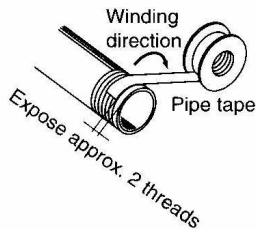

3. Avoid connecting ground lines to piping, as this may cause electric corrosion of the system.

4. Tighten piping with the proper tightening torque.

When attaching fittings to valves, tighten with the proper tightening torque shown below.

Tightening Torque for Piping

Connection thread	Proper tightening torque (N·m)
Rc1/8	7 to 9
Rc1/4	12 to 14
Rc3/8	22 to 24
Rc1/2	28 to 30
Rc3/4	45 to 50
Rc1	65 to 70
Rc1 1/4	80 to 90
Rc1 1/2	100 to 110
Rc2	140 to 150

5. Connection of piping to products

When connecting piping to a product, refer to its operation manual to avoid mistakes regarding the supply port, etc.

Operating Environment

⚠ Warning

- Do not use in an atmosphere having corrosive gases, chemicals, sea water, water, water steam, or where there is direct contact with any of these .
- Do not use in explosive atmospheres.
- Do not use in locations subject to vibration or impact.
- Do not use in locations where radiated heat will be received from nearby heat sources.
- Employ suitable protective measures in locations where there is contact with water droplets, oil or welding spatter, etc.

Maintenance

⚠ Warning

1. Removal of product

The valve will reach a high temperature when used with high temperature fluids. Confirm that the valve temperature has dropped sufficiently before performing work. If touched inadvertently, there is a danger of being burned.

- Shut off the fluid supply and release the fluid pressure in the system.
- Shut off the power supply.
- Dismount the product.

2. Low frequency operation

Switch valves at least once every 30 days to prevent malfunction. Also, in order to use it under the optimum state, conduct a regular inspection once a half year.

⚠ Caution

1. Filters and strainers

- Be careful regarding clogging of filters and strainers.
- Replace filter elements after one year of use, or earlier if the pressure drop reaches 0.1MPa.
- Clean strainers when the pressure drop reaches 0.1MPa.

2. Lubrication

When using after lubricating, never forget to lubricate continuously.

3. Storage

In case of long term storage after use with heated water, thoroughly remove all moisture to prevent rust and deterioration of rubber materials, etc.

4. Exhaust the drainage from an air filter periodically.

Precautions

⚠ Warning

- Valves will reach high temperatures from high temperature fluids. Use caution, as there is a danger of being burned if a valve is touched directly.
- For pilot type 2-port solenoid valves, when the valve is closed, sudden pressure resulting from the startup of the fluid supply source (pump, compressor, etc.) may cause the momentary valve to open and leakage to occur, so please exercise caution.
- When problems are caused by a water hammer, install water hammer relief equipment (accumulator, etc.). Please consult with SMC for details.



VNC / VNH Series Solenoid Valves for Fluid Control Precautions 3

Be sure to read this before handling.

How to use DIN connector

Disassembly

- Loosen screw (1) and pull up housing (2) in the direction of screw (1) to remove the connector from the body (solenoid).
- Pull out screw (1) from housing (2).
- On the bottom part of terminal block (3), there is a notch (9). If a small flat head screwdriver is inserted into the gap between housing (2) and terminal block (3), terminal block (3) will be removed from housing (2). (See diagram at the top right of the page.)
- Remove cable gland (4), washer (5) rubber seal (6).

Wiring

- Insert cable gland (4), washer (5) and rubber seal (6) into cable (7) in order, and insert it into housing (2).
- Loosen screws (11) on terminal (3). Insert lead wires (10) and tighten screws (11) again.

Note 1) The tightening torque should be 0.5 N·m +/- 15%.

Note 2) The applicable outside diameter of cable (7) is $\phi 6$ to 8 mm.

Note 3) Round or Y-shaped crimped terminal cannot be used.

Assembly

- Insert cable gland (4), washer (5) and rubber seal (6) and housing (2) into cable (7) in order. Connect cable (7) to terminal block (3) and fix terminal block (3) to housing (2) in place. (Push it down until you hear the click sound.)
- Insert rubber seal (6) and washer (5) into the cable entry on housing (2) in order, and tighten cable gland (4) securely.
- Insert gasket (8) into the gap between the bottom of terminal box (3) and plug on the equipment, and insert screw (1) from the top of housing (2) to tighten them.

Note 1) The tightening torque should be 0.5 N·m +/- 20%.

Note 2) The orientation of the connector can be changed by 180 degrees depending on the mounting direction of housing (2) and terminal box (3).

Connector for DIN Terminal

Description	Part no.
DIN connector	B1B09-2A (Standard)
	GM209NJ-B17 (CE-compliant)

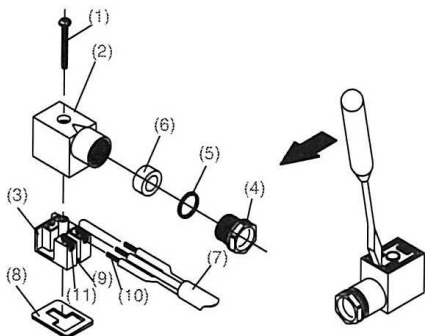

Indicator Light/Surge Voltage Suppressor

Caution

VNC1 (Valve size 1)

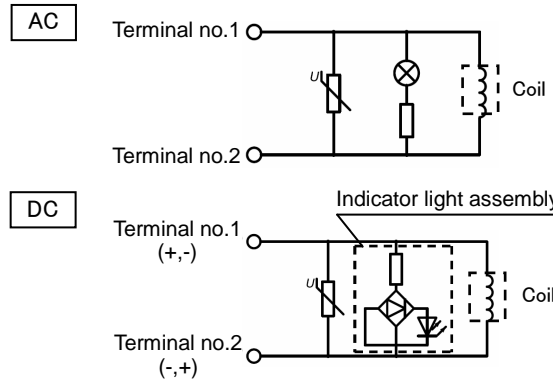

VNC2 to 9 (Valve size 2 to 9), VNH

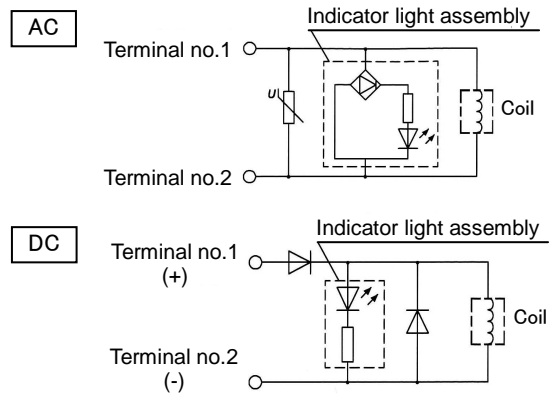

Electrical Connection

Caution

The DIN connector terminal and conduit terminal (with indicator light/surge voltage suppressor) are wired internally as shown below. Connect each of the wire to the corresponding wire of the power supply.

DIN terminal block

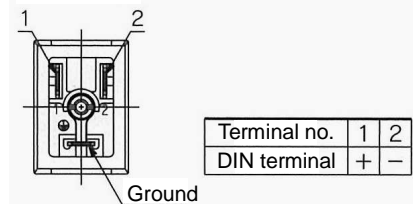

- Applicable cord outside diameter

D type: $\phi 6$ to 8 mm

Lead wire colour

Voltage specification	Colour
100 VAC	Blue
200 VAC	Red
DC polar indication	Red (+), black (-)
Others	Gray



VNC / VNH Series Solenoid Valves for Fluid Control Specific Product Precautions 1

Be sure to read this before handling.

Design

Warning

1. Extended periods of continuous energization

If a valve is continuously energized for long periods, heat generation of the coil may result in reduced performance and shorter service life. This may also have an adverse effect on the peripheral equipment in proximity. Should a valve be continuously energized for long periods, or its daily energized state exceeds its non energized state, please use an energy saving type AC, energizing for long periods of time continuously, select the air-operated valve and use the continuous duty type of the VT307 for a pilot valve.

Mounting

Warning

1. Do not apply external force to the coil section.

When tightening is performed, apply a wrench or other tool to the outside of the piping connection parts.

2. Do not warm the coil assembly with a heat insulator, etc.

Use tape, heaters, etc., for freeze prevention on the piping and body only. They can cause the coil to burn out.

3. Avoid sources of vibration, or adjust the arm from the body to the minimum length so that resonance will not occur.

4. Mount a valve with its coil position upwards, not downwards.

5. Mount the VNH series vertically top side up.

Wiring

Caution

1. Applied voltage

When electric power is connected to a solenoid valve, be careful to apply the proper voltage. Improper voltage may cause malfunction or coil damage.

2. Confirm the connections.

After completing the wiring, confirm that the connections are correct.

Piping

Caution

When high temperature fluids are used, use fittings and tubing with heat resistant features. (Self-align fittings, fluoropolymer tubing, Copper piping, etc.)

Mounting Direction of Pilot Solenoid Valve

Warning

If the product is an external type pilot, it is not splash proof. Be careful not to expose it to any fluid when maintaining the valve.

Caution

When replacing a valve, if an external pilot solenoid valve is mounted in the wrong direction, it may malfunction or leak air.

External Pilot

Caution

Pilot port 12(P1) and 10(P2) piping

P1 and P2 piping should be as follows according to the model.

Port	Air operated		Solenoid
	VNC□0 ¹ / ₄ □ VNH	VNC□02□	VNC□1 ¹ / ₄ □ VNH
12 (P1)	External pilot	Bleed port	External pilot
10 (P2)	Bleed port	External pilot	Pilot exhaust

Installing a silencer to the exhaust port and the bleed port is recommended for noise reduction and for dust entry prevention.

Quality of Operating Fluid

Caution

Please note that using fluids that contain foreign material (especially hard objects like glass chips), may cause damage to the valve, will reduce sealing performance, and may cause early failure.

Back Pressure of 3 port Valve (Series VNH)

Caution

1). Ensure that back pressure of 3(B) port from VNH□13 is less than 5 MPa.



VNC / VNH Series Solenoid Valves for Fluid Control Specific Product Precautions 2

Be sure to read this before handling.

Water Hammer (Series VNC)

VNC□□1□ (N.C. 0.49MPa)
Conditions : piping length/ 30 m
total pressure in
copper tube/ 0.49 MPa

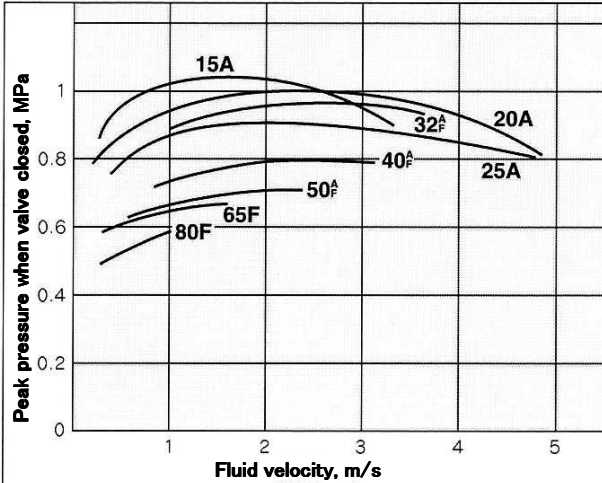

VNC□□4□ (N.C. 0.97MPa)
Conditions : piping length/ 30 m
total pressure in
copper tube/ 0.49 MPa

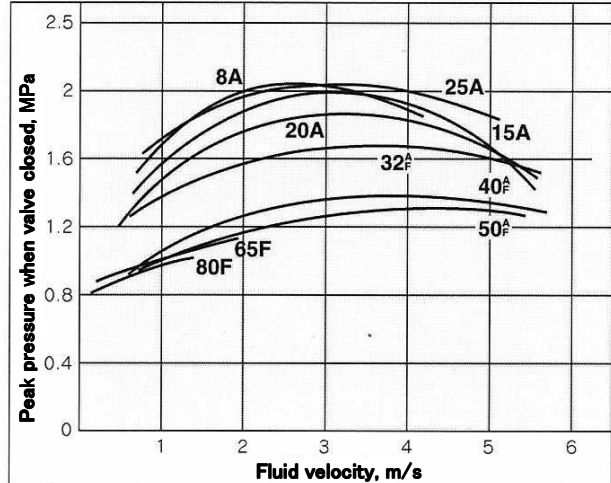

Equation to obtain fluid velocity

$$v = 21.2 \times Q / d^2$$

(Symbols)

v: fluid velocity (m/s)

Q: flow rate (l/min)

d: internal diameter of pipe (mm)

Troubleshooting

Seek the same trouble from the following table, and take the appropriate countermeasure.

Trouble	Item to check	Countermeasure
Operation failure	Is the voltage the rated voltage?	Use the rated voltage.
	Is the wiring correct?	Wire correctly.
	Is the switching signal normal?	Apply the specified voltage to the valve correctly.
	Is the pressure within the specified range?	Move the pressure within the specified pressure range.
	Is manual operation available?	Replace the valve.
	Is there drainage accumulation?	Exhaust the drainage from the filter etc., and supply lubricant.
Air leak	Is the piping correct?	Check the piping port.
	Is sealing agent applied to the pipe joint?	Apply the sealing agent to the pipe joint.
	Is the tightening torque correct?	Apply appropriate tightening torque.
Response delay	Is the pressure within the specified range?	Move the pressure within the specified pressure range.
	Is the voltage the rated voltage?	Use the rated voltage.
	Is the actuator's capacity appropriate?	Use a smaller actuator, or replace the valve.
	Is the setting of the speed controller correct?	Adjust the speed controller.
	Is there drainage accumulation ?	Exhaust the drainage from the filter etc., and supply lubricant.
Coil burn	Is the voltage the rated voltage?	Replace the valve with one which is compatible with the voltage.
	Is there liquid on the pilot valve?	Replace the valve, and then take countermeasures which protects against liquid.
Beat and noise	Is the voltage the rated voltage?	Apply the specified voltage.

If any applicable defect is found after checking the above items, the valve has some trouble. In that case, stop using the valve immediately.

If any of the following practices are applicable, the valve may have some trouble inside. In that case, stop using the valve immediately.

- (1) Voltage other than the rated voltage was applied.
- (2) Lubricant other than the specified lubricant was supplied.
- (3) Lubrication was stopped intermediately, or lubrication was stopped temporarily.
- (4) The valve was directly exposed to liquid such as water.
- (5) Intense vibration was applied.
- (6) Foreign matter such as drainage and dust entered.
- (7) Any other practices which are covered by the precautions stated in this operation manual occurred.

*If the valve seems to fail, return it to SMC as it is.

Revision history		
A	Safety Instructions	Po
B	Renewal	RP
C	Renewal	RW

A	Safety Instructions	Po
B	Renewal	RP
C	Renewal	RW

1st printing: MZ

SMC Corporation

4-14-1, Sotokanda, Chiyoda-ku, Tokyo 101-0021 JAPAN

Tel: + 81 3 5207 8249 Fax: +81 3 5298 5362

URL <http://www.smcworld.com>

Note: Specifications are subject to change without prior notice and any obligation on the part of the manufacturer.
© 2011 SMC Corporation All Rights Reserved